



Speciale TRACKLIGHT

APOLO

The Compact Tracklight.

With a very high Colour Rendering Index (CRI>90), it ensures faithful colour reproduction without alterations.

Choose the model that best suits your needs:

- 3 formats: tracklight, recessed and surface-mounted.
- 3 power options: 9W, 18W and 30W.
- 5 angles: 15°, 23°, 38°, 45° and 60°.
- 3 colour temperatures: 4000K, 3000K and 2700K.
- 2 finishes: white and black.

You also have the option to choose the luminaire's inner ring in gold.

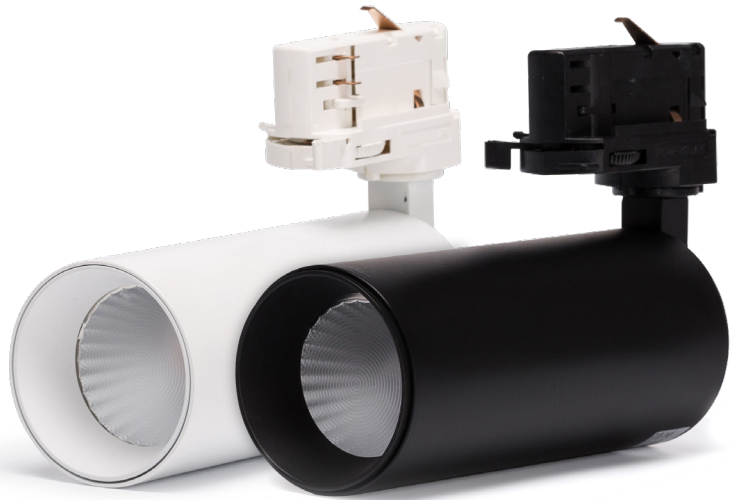

• Features

• Dimming Opt.

• Angles

Small

Gold ring available.



And as a **NEW FEATURE** you can choose the APOLO for GU10 lamps. Available from September 2024. Lamp not included.



CR Carril POL2.GU10 B

EM Recessed N

SP Surface D

*Create your reference

Format	W	CRI	CCT	Angle	Ring	OPTIONAL								
CR Carril	POL2. (Apolo)	09	9 W	9	>90	4	● 4000K	15	15°	B	<input type="checkbox"/>	B	<input type="checkbox"/>	<input type="checkbox"/> TRIAC <input checked="" type="checkbox"/> D
EM Recessed	18	18 W	3	● 3000K	23	23°	N	<input checked="" type="checkbox"/>	N	<input checked="" type="checkbox"/>				
SP Surface	30	30 W	2	● 2700K	38	38°	D	<input checked="" type="checkbox"/>	D	<input checked="" type="checkbox"/>				
					45	45°								
					60	60°								

W	CCT	Beam	Light	W	CCT	Beam	Light	W	CCT	Beam	Light
● 4000K	1080 lm	909 lm	● 4000K	2160 lm	1818 lm	● 4000K	3600 lm	3030 lm			
● 3000K	1071 lm	873 lm	● 3000K	2142 lm	1746 lm	● 3000K	3570 lm	2910 lm			
● 2700K	1062 lm	855 lm	● 2700K	2124 lm	1710 lm	● 2700K	3540 lm	2850 lm			

HERMES

The most complete tracklight on the market, with an aluminum body.

In one single product, it includes three colour temperatures and three powers (30W, 35W, and 40W), selectable via manual switches.

Additionally, it is $CRI > 90$ and is equipped with a zoom function to adjust the angle, varying from 24° to 60° . You just need to choose the finish: white or black.

One product, many different possibilities!



• Features

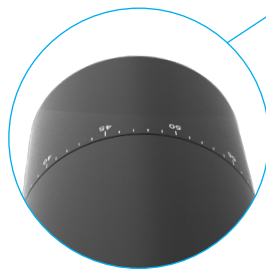
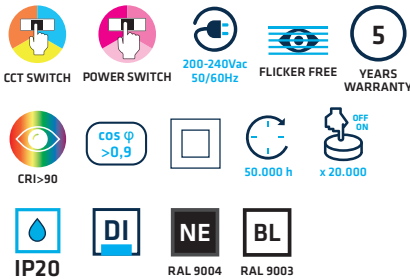

$24^\circ \sim 60^\circ$ Adjustable angle $24^\circ \sim 60^\circ$

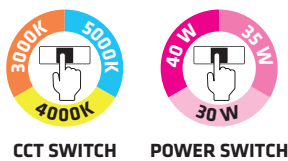

	W	CCT		
CRH3040C9CCT	30 W	5000K	3600 lm	3000 lm
		4000K	3600 lm	3000 lm
		3000K	3450 lm	2850 lm
	35 W	5000K	4200 lm	3500 lm
		4000K	4200 lm	3500 lm
		3000K	4025 lm	3325 lm
	40 W	5000K	4800 lm	4000 lm
		4000K	4800 lm	4000 lm
		3000K	4600 lm	3800 lm

0
2

After the reference, add 0 for white finish or 2 for black finish.

ARES

The most competitive tracklight.

Available in white and black, it is equipped with a switch to select the color temperature and power.

You only need to choose the finish, whether white or black, and the beam angle, whether 45° or 60°. Power and colour temperature can be selected directly on the product.



• Features

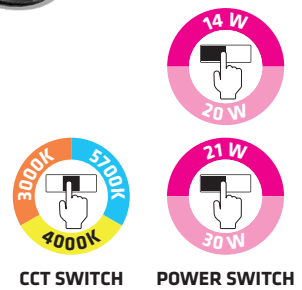
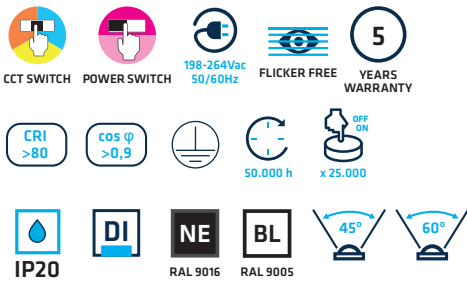

Model	Finish	Beam Angle	W	CCT	Beam Diameter	Beam Diameter
CRA1420CCT45	0 □ 2 ■	45°	14 W	5700K	1580 lm	1300 lm
				4000K	1580 lm	1300 lm
				3000K	1455 lm	1180 lm
			20 W	5700K	2170 lm	1770 lm
				4000K	2170 lm	1770 lm
				3000K	1960 lm	1560 lm
CRA1420CCT60	0 □ 2 ■	60°	14 W	5700K	1580 lm	1300 lm
				4000K	1580 lm	1300 lm
				3000K	1455 lm	1180 lm
			20 W	5700K	2170 lm	1770 lm
				4000K	2170 lm	1770 lm
				3000K	1960 lm	1560 lm
CRA2130CCT45	0 □ 2 ■	45°	21 W	5700K	2350 lm	1950 lm
				4000K	2350 lm	1950 lm
				3000K	2190 lm	1770 lm
			30 W	5700K	3180 lm	2570 lm
				4000K	3180 lm	2570 lm
				3000K	2940 lm	2350 lm
CRA2130CCT60	0 □ 2 ■	60°	21 W	5700K	2350 lm	1950 lm
				4000K	2350 lm	1950 lm
				3000K	2190 lm	1770 lm
			30 W	5700K	3180 lm	2570 lm
				4000K	3180 lm	2570 lm
				3000K	2940 lm	2350 lm

METIS

The tracklight for GU10 lamps.

Its main features are easy installation and minimalist design.

Thanks to the suction cups, you can effortlessly install the GU10 LED lamp.

It is available as a tracklight or surface-mounted for 1, 2, 3, or 4 spotlights, each independently adjustable.



SUCTION CUP INCLUDED*

*Required to place and change the light bulb.



METIS TRACKLIGHT



METIS SUPERFICIE 1 PC.



METIS SUPERFICIE 3 PCS.



METIS SUPERFICIE 2 PCS.



METIS SUPERFICIE 4 PCS.



THREE-PHASE TRACK ACCESSORIES

Accessories for every type of installation.

Looking for the perfect solution to illuminate commercial spaces, public areas, or offices? THREELINE has the right solution for you, selected by lighting professionals.

Top quality:

Trust our experience and 100% guaranteed quality.

Great versatility:

From stores and warehouses to restaurants, airports, and public buildings, we adapt to any environment.

Easy expansion:

Need more light? No problem. The modular structure of the tracks makes expansion easy according to your needs. Designers can adapt the system to the space, and the installation can be quickly and easily done thanks to the connectors, which save time in the process.

Don't miss the opportunity to transform your spaces, illuminating them with style, thanks to the tracklight accessories!

Check the examples below to see all the installation possibilities.

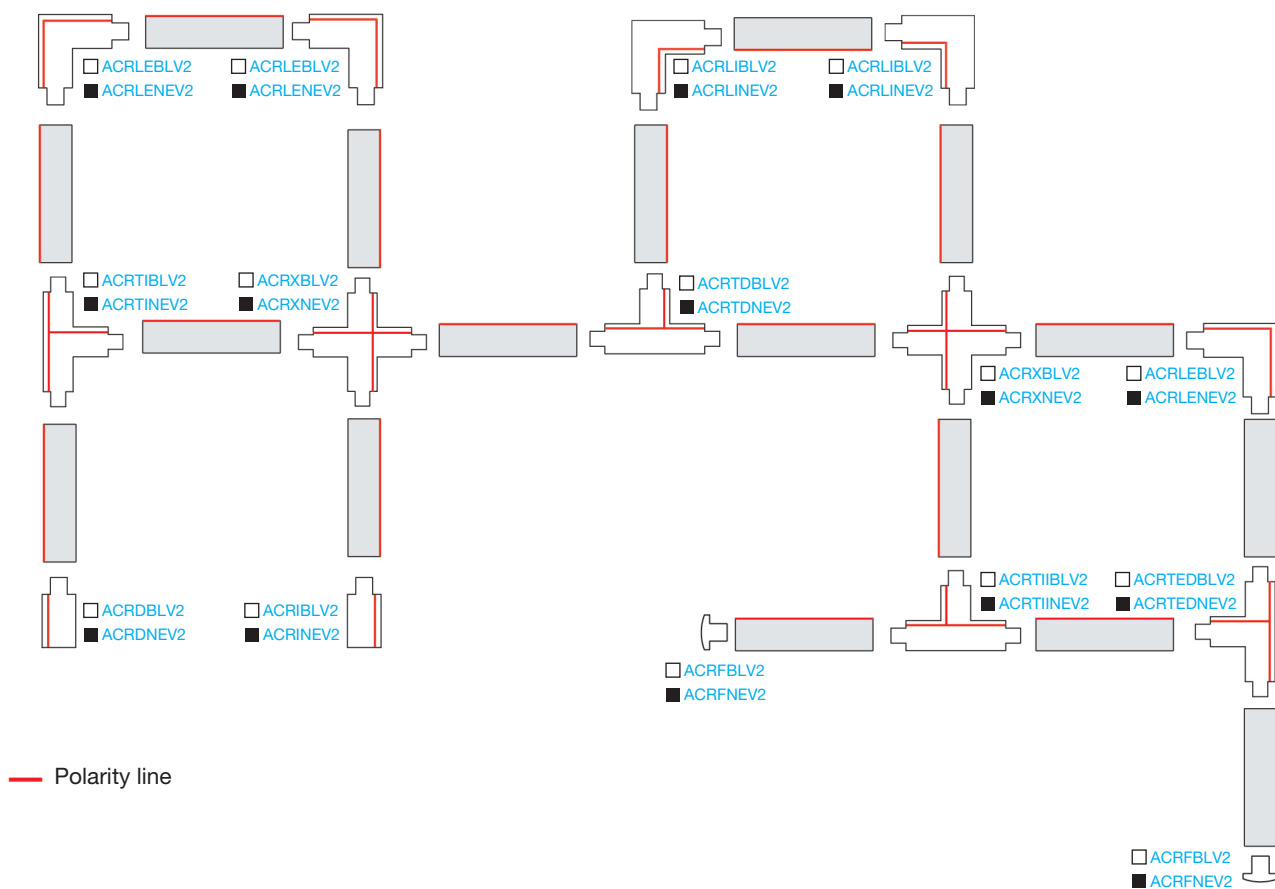
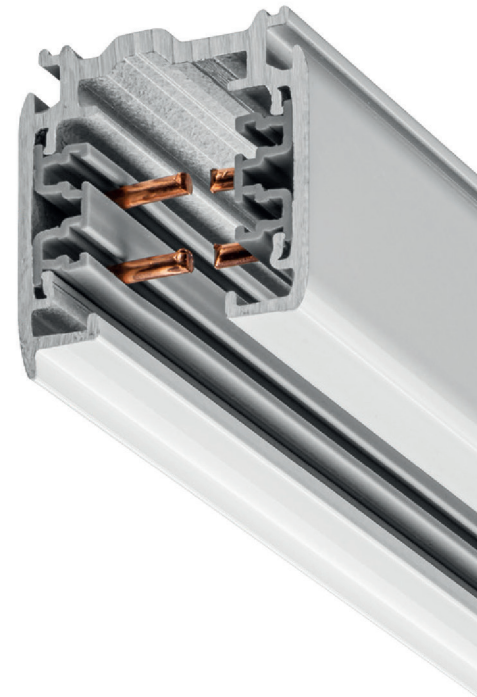

SURFACE Track

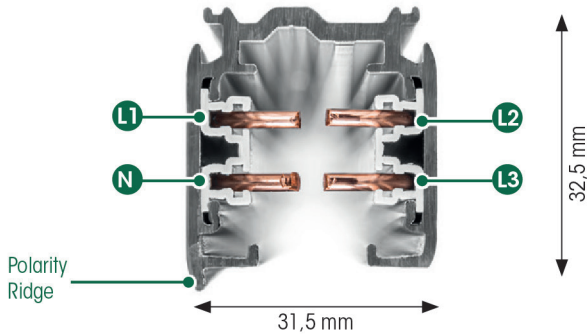

RECESSED Track

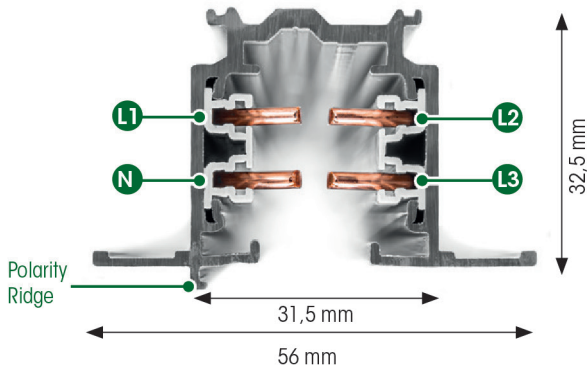

Cross-sectional area of the power conductor

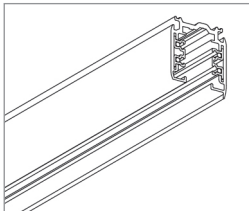
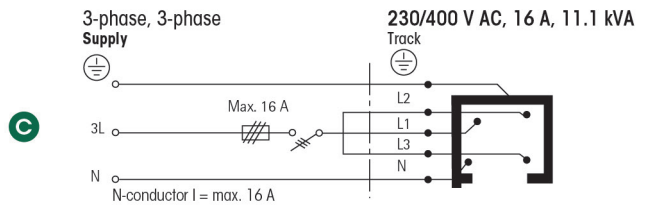
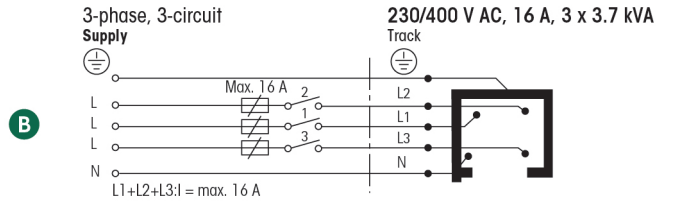
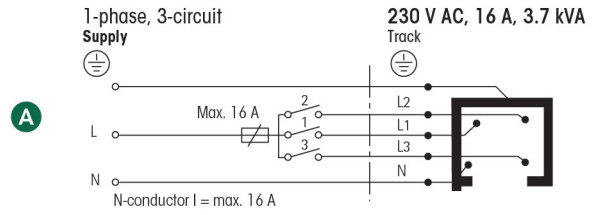

Surface Electrified Track

BL 1m. ACR1BLV2	BL 2m. ACRBLV2	BL 3m. ACR3BLV2
NE 1m. ACR1NEV2	NE 2m. ACRNEV2	NE 3m. ACR3NEV2

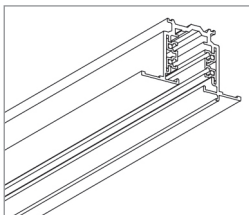

Recessed Electrified Track

BL 1m. ACRE1BLV2	BL 2m. ACREBLV2	BL 3m. ACRE3BLV2
NE 1m. ACRE1NEV2	NE 2m. ACRENEV2	NE 3m. ACRE3NEV2

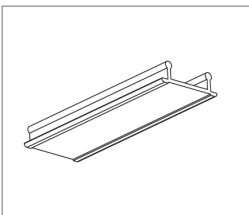

Track cover accessory

BL ATCRBLV2
NE ATCRNEV2

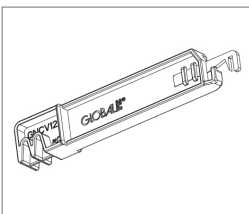

Manual conductor bending tool

ACRHDCV2

ACCESSORIES FOR COUPLING AND POWER SUPPLY

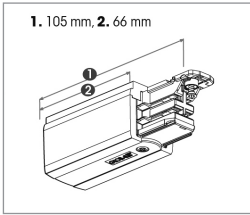

Side power supply

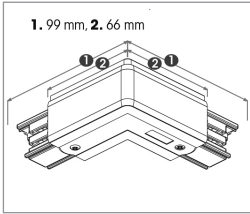

L-coupler

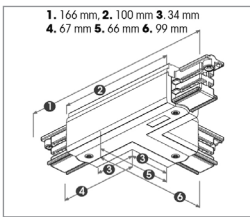

T-coupler

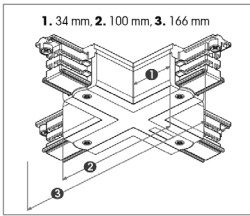

X-coupler

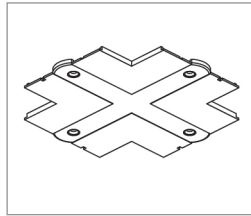
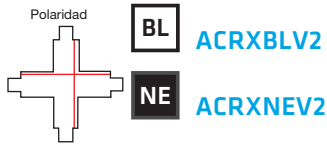

Recessed power supply frame - X-shaped

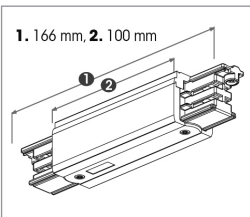

Central power supply

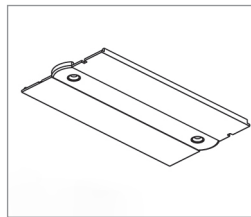

Recessed power supply frame - Straight

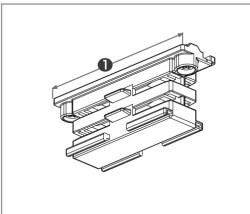
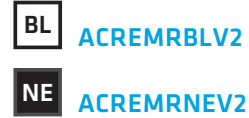

Inner coupler

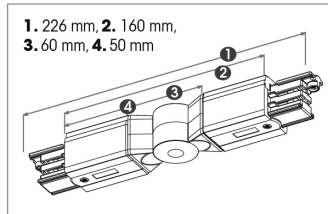

Adjustable coupler

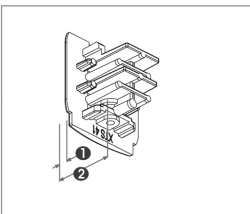

End cap

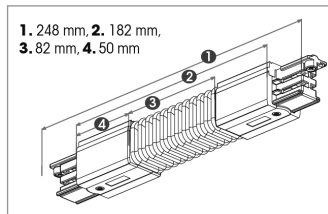

Flexible coupler



SUSPENSION ACCESSORIES

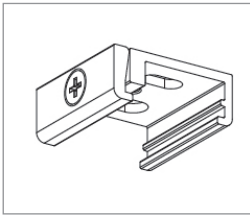

Surface bracket

BL [AASCRBLV2](#)

NE [AASCRNEV2](#)

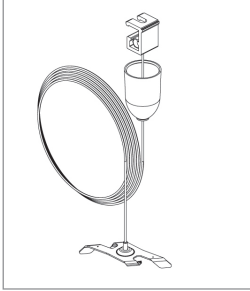

Suspension kit with clips

BL 1,5m. [ACRS1BLV2](#)

BL 3m. [ACRSBLV2](#)

BL 5m. [ACRS5BLV2](#)

NE 1,5m. [ACRS1NEV2](#)

NE 3m. [ACRSNEV2](#)

NE 5m. [ACRS5NEV2](#)

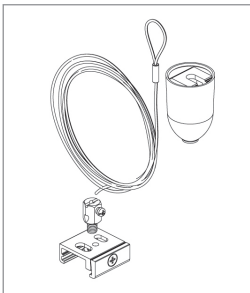

Suspension kit with brackets

BL 1,5m. [ACRSA1BLV2](#)

BL 3m. [ACRSA3BLV2](#)

BL 5m. [ACRSA5BLV2](#)

NE 1,5m. [ACRSA1NEV2](#)

NE 3m. [ACRSA3NEV2](#)

NE 5m. [ACRSA5NEV2](#)

MULTIADAPTER ACCESSORIES

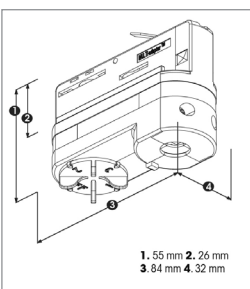

10A Multi-circuit adapter

BL [AMC10BLV2](#)

NE [AMC10NEV2](#)

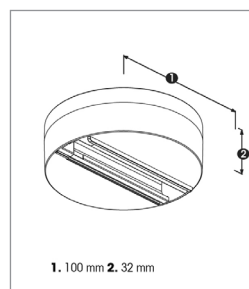

Surface accessory

BL [AST110BLV2](#)

NE [AST110NEV2](#)

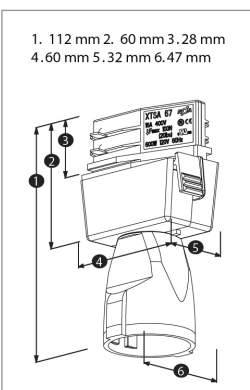

16A Schuko adapter

BL [ASCHU16BLV2](#)

NE [ASCHU16NEV2](#)

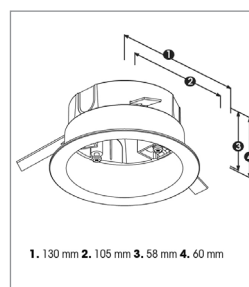

Recessed case for surface accessories

BL [AET105BLV2](#)

NE [AET105NEV2](#)





THREELINE 

