



# THREELINE

## CATALOGUE

LED STRIPS AND PROFILES  
*STRIP LED E PROFILI*



# LED Strips / Strip LED

20

## 24 High Efficiency Single-colour / Monocolore Alta Efficienza

24 STRAK X



ST96X2 / ST96X6

25 STRAK X



ST14X2 / ST14X6

26 STRAK X

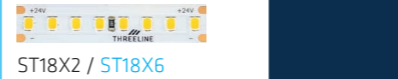

ST18X2 / ST18X6

## 28 High CRI Single-colour / Monocolore Alto CRI

28 STRAK H



ST48H2 / ST48H6

30 STRAK H

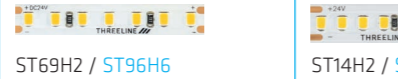

ST69H2 / ST96H6

32 STRAK H



ST14H2 / ST14H6

34 STRAK H



ST19H2 / ST19H6

## 36 Special Single-colour / Monocolore Speciale

36 STRAK T (Narrow)



ST96T2

37 STRAK L (Side-Emitting)



ST12L2 / ST12L6

38 STRAK S (S-Shaped)



ST19S2

## 40 COB / COB

40 STRAK C



ST05C2 / ST05C6

41 STRAK C



ST10C2 / ST10C6

42 STRAK C



ST18C2 / ST18C6

44 STRAK C



ST13C2R

## 46 Two-colour / Bicolore

46 STRAK HB



ST96H2B / ST96H6B

47 STRAK HB

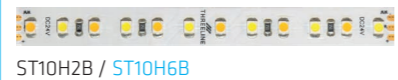

ST10H2B / ST10H6B

48 STRAK HB



ST19H2B / ST19H6B

## 50 Dim-to-Warm / Dim-to-Warm

50 STRAK WB



ST12W2B / ST12W6B

## 52 RGB / RGB

52 STRAK XR



ST14X2R / ST14X6R

53 STRAK HR



ST14H2R

## 54 RGB + W / RGB + W

54 STRAK R3



ST14R23 / ST14R63

## 56 RGB + TW (Tunable White) / RGB + TW

56 STRAK RB



ST17R2B / ST17R6B

## 58 Digital / Digitale

58 STRAK DR



ST14D6R

59 STRAK D6



ST19D6E

## 60 IP20 LED Strip Accesories / Accessori Strip LED IP20

60 STRIP-TO-STRIP CONNECTION



LED Strip | 8/10/12 mm | 2/4/5/6 Poles

60 STRIP-TO-POWER SUPPLY CONNECTION



LED Strip | 8/10/12 mm | 2/4/5/6 Poles

61 STRIP-TO-STRIP CONNECTION WITH CABLE



LED Strip | 8/10/12 mm | 2/4/5/6 Poles

## 62 NEON FLEX / NEON FLEX

63 NEON TOP NF72F6



64 NEON SMOOTH LINE NF15S6 / NF15S6R



66 NEON SIDE NF77L6 / NF14L6R



68 NEON 360° NF12C6 / NF12C6R

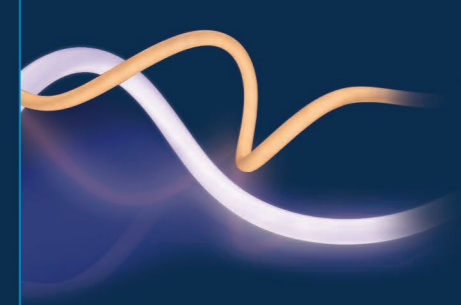

## 74 Surface / Superficie



## 86 Curved Surface / Superficie Curva



## 90 Recessed / Da Incasso

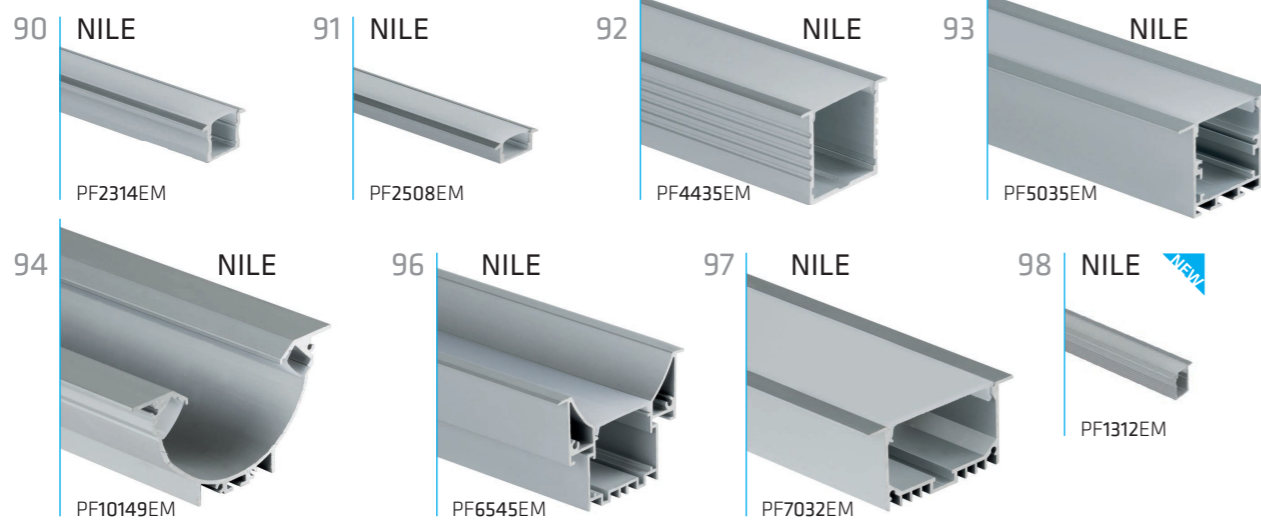

## 100 Suspension - Surface / Sospeso - Superficie



## 106 Architectural / Architettuale

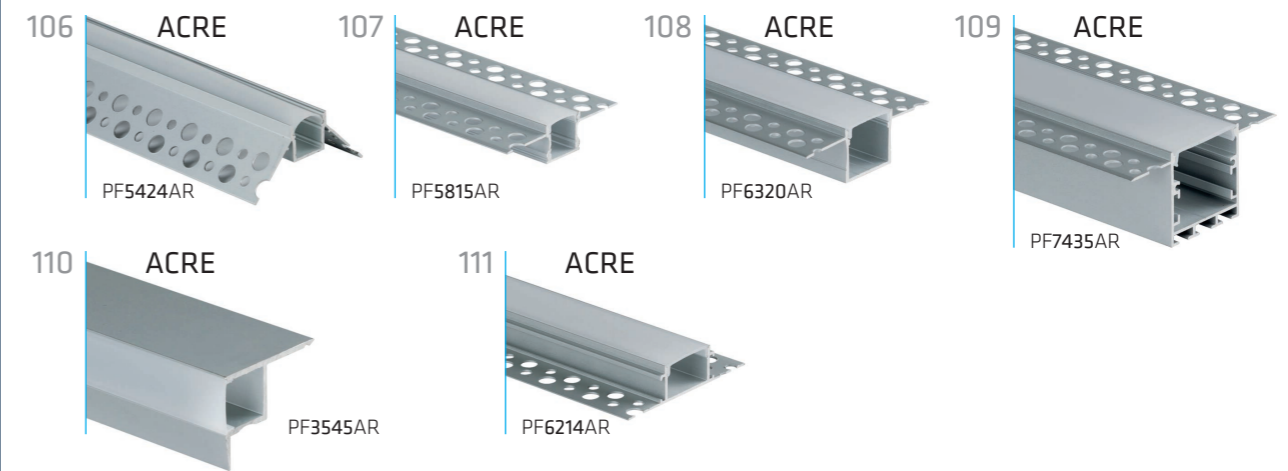

## 114 Corners / Angolare



## 120 Staircase - Corner / Scale - Angolare

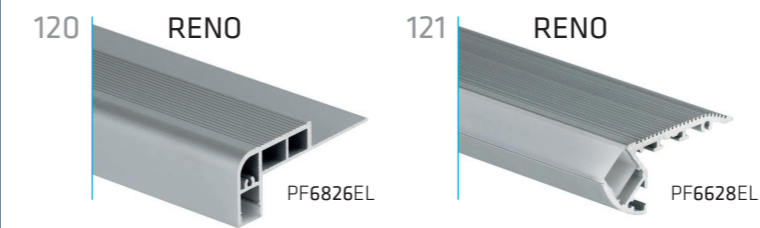

## 122 Floor / Pavimento



## 126 Wall / Parete

- 126 EBRO  
PF4213PD
- 127 EBRO  
PF4913PD
- 128 EBRO  
PF7060PD
- 129 EBRO  
PF4084PD

## 130 Tubes / Tubi

- 130 OKOA  
PF0430TB

## 132 Skirting Board / Battiscopa

- 132 GANGES  
PF8016RD

## 134 Heat Sink Plates / Piastre di Dissipazione

- 134 DAO  
PF1503CH
- 135 DAO  
PF1508CH
- 136 DAO  
PF1515CH
- 137 DAO  
PF1235CH

## 138 Profiles Accessories / Accessori Profili

# Controllers / Controller

# 140

- 146 DIGITAL  
CTR XD
- 146 0/1-10V  
TDIM12A
- 147 DALI  
CRTDAW  
CRTDARGBI  
CRTDARGB+W
- 148 WALL TOUCH  
4TW  
4TBI  
4TRGB  
4TRGB+W
- 149 MULTIZONE WALL TOUCH  
4TDX8 / DX8RF
- 150 WALL TOUCH + RF  
4TRTW  
4TRTBI  
4TRTRGB  
4TRTRGB+W

- 151 RF REMOTE CONTROLS  
RTW  
RTBI  
RTRGB  
CTRLED RGB  
RTRGB+W  
RTMZRGBTW / R5MRGBTW
- 152 MULTIZONE RF  
RTMZW / RTMZBI  
R3MWBI  
RTMZRGBW  
RTMZRGBTW  
R4MRGBW  
R5MRGBTW
- 154 DMX  
CTRDECDMXV2
- 155 INTERFACE  
SLESA-U9  
SLESA-U10  
SLESA-U11
- 156 (BLUETOOTH) CASAMBI  
CSB1224DC
- 156 CASAMBI ACTUATORS  
CSB4SWNE  
CSB4SWBL
- 157 (WIFI) SMART HOME  
SMART-CRT
- 158 AMPLIFIERS  
AMPLEDW  
AMPLEDBI  
AMPLEDRGBN  
AMPLEDRGB  
AMPLERGB+W  
AMPLEDRT

# Power Supplies / Alimentatori

# 160

- 162 IP20 ENCLOSED  
VLED24R35W  
VLED24R60W  
VLED24R100W  
VLED24R150W  
VLED24R250W  
VLED24R350W / VLED24R400W
- 164 COMPACT ON-OFF IP20  
DTC24-30W  
DTC24-60W  
DTC24-75W  
DTC24-120W  
DTC24-150W
- 165 COMPACT DALI-PUSH IP20  
D2P20-45-24  
D2P20-80-24  
D2P20-150-24  
D2P20-250-24
- 166 SLIM IP20  
DTLIN24-30W  
DTLIN24-60W  
DTLIN24-100W  
DTLIN24-160W
- 168 WATERPROOF ON-OFF IP67  
VLED24-E30W  
VLED24-E60W  
VLED24-E100W  
VLED24-E150W  
VLED24-E250W
- 169 WATERPROOF DALI-PUSH IP66  
D2P66-100-24  
D2P66-150-24  
D2P66-200-24  
D2P66-300-24

**+18** years of experience  
anni di esperienza

**33** presence in 33 countries  
presenza in 33 paesi

**4.5k** more than 4500 products  
più di 4.500 articoli

**1.5k** more than 1500 clients  
più di 1.500 clienti

## 🇬🇧 About us

Threeline Technology is a young and dynamic team focused each day on doing our best to strengthen the brand and position it as a LED market leader.

We began in Almansa (Spain) in 2006 as a lighting electronics company and have evolved to offer all types of LED lighting.

Our R&D department and technical department strive to develop innovative products in our lab and offer customers advice on all types of lighting projects.

Our main aim is to develop high quality and efficient products at competitive prices to achieve an energy saving of more than 80%.

## Su di noi 🇮🇹

Noi di Threeline Technology siamo un team giovane e dinamico che lavora giorno dopo giorno per offrire la migliore versione di sé e far crescere il marchio, posizionandolo come riferimento principale nel settore del LED.

Siamo nati ad Almansa (Spagna) nel 2006 come azienda operante nel settore dell'elettronica per l'illuminazione, evolvendoci fino ad oggi per offrire ogni tipo di illuminazione LED.

L'Ufficio R&S e l'Ufficio Tecnico lavorano nel nostro laboratorio per sviluppare prodotti innovativi e offrire consulenza ai nostri clienti in ogni genere di progetti di illuminazione.

Il nostro principale obiettivo è quello di puntare su un prodotto di qualità a prezzi competitivi e con una grande efficienza, ottenendo un risparmio energetico di oltre l'80%.

## R&D And Quality Control

Threeline's technical, R&D and quality control departments comprise a single body focused, to a large extent, on research, design and development of new products and solutions, as well as on constant and exhaustive quality control at each stage of the manufacturing process.

To this end, we have many specialised tools and devices:

- 3D printers to make the first computer-developed designs and prototypes a reality before large-scale production.
- Thermographic camera to carry out detailLED analysis of the temperature reached at each moment by all product components and to identify product temperature ranges, limitations, and critical points.
- Laser for marking and differentiating references and batch numbers, for custom and independent product traceability.
- Ulbricht integrating sphere for accurate product electrical, photometric and colorimetric measurements.

## R&S e Controllo Qualità

Parlare di Ufficio Tecnico, R&S e Controllo Qualità di THREELINE in realtà significa parlare di un solo ente focalizzato, in gran parte, sulla ricerca, sulla progettazione e sullo sviluppo di nuovi prodotti e soluzioni, nonché sul controllo costante e rigoroso della qualità in tutte le fasi del processo produttivo.

A tal fine, disponiamo di un gran numero di strumenti specifici:

- Stampanti 3D per realizzare i primi progetti e prototipi, sviluppati al computer prima di realizzare la produzione su vasta scala.
- Termocamera per effettuare l'analisi dettagliata della temperatura raggiunta in ogni momento da tutti i componenti che costituiscono un prodotto e per determinare l'esistenza di punti critici, nonché le limitazioni e gli intervalli di temperatura dei prodotti.
- Laser per la marcatura e la differenziazione dei codici e dei numeri di lotto, che permette la completa tracciabilità di ogni prodotto in modo personalizzato e indipendente.
- Sfera integratrice di Ulbricht per l'ottenimento obiettivo di parametri elettrici, fotometrici e colorimetrici dei prodotti.

## Languages

Our team can communicate and assist in a variety of languages:



Hablamos Español



We speak English



On parle Français



Noi parliamo Italiano



Nós falamos Português

## Lingue

Il nostro team è pronto per servirvi in:

## Production

Our production department manufactures and customises all the materials requested by the customer, for both exterior finishes and dimming options.

## Produzione

Il nostro Ufficio Produzione si occupa della costante fabbricazione e personalizzazione, sia per quanto riguarda le finiture esterne che per le opzioni di regolazione, di tutto il material se richiesto dal cliente.

## Certifications

## Certificazioni

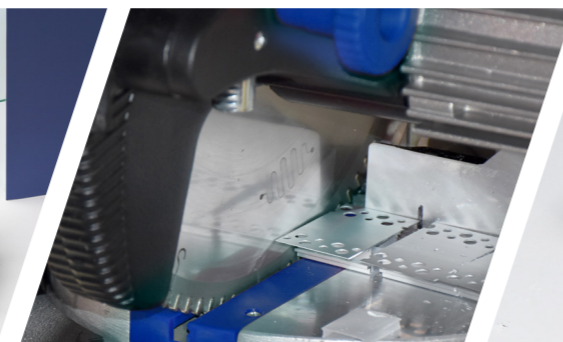



## Customer Service

We conduct comprehensive and personalised lighting studies, according to the lighting requirements specified by the customer and in compliance with current regulations, to provide a simulation of the final result of their indoor or outdoor lighting installation.

Relying on the most advanced software, such as DIALux, we calculate lighting for industrial facilities, street lighting, shopping centres, sports facilities, hotels, offices, restaurants and even private homes.

### Energy saving and amortisation studies

With a few simple and objective calculations, our customers will get to know the real savings of switching from traditional luminaires to LED luminaires. The study will also indicate how long it will take to write off the investment.

### Technical documentation

Product technical data sheets and certificates issued by external laboratories endorsing our products are available on our website.

### Technical support

Our sales service provides a swift and efficient response, via telephone and/or email, to clear up any technical queries our customers may have before purchase, during installation and afterwards.

### Project Consultancy Service

After analysing the requirements and lighting needs, our engineering team works closely with our customers to bring their projects to life, providing specialised advice and comprehensive management services.

## Servizio Clienti

Mediante completi studi di illuminazione personalizzati, attenendoci ai requisiti di luminosità specificati dal cliente, oltre al rispetto della normativa vigente, offriamo una simulazione di quello che sarà il risultato finale del suo futuro impianto di illuminazione sia in progetti per interni che per esterni.

Basandoci sul software più avanzato, DIALux, eseguiamo calcoli di illuminazione per capannoni industriali, illuminazione pubblica e stradale, centri commerciali, impianti sportivi, alberghi, uffici, ristoranti e persino abitazioni private.

### Studi di risparmio energetico e ammortamento

Tramite calcoli semplici e oggettivi, i nostri clienti sapranno quale sarà il risparmio reale ottenuto sostituendo lampade tradizionali con lampade LED THREELINE. Grazie a questo studio potranno anche conoscere il tempo reale necessario per ammortizzare l'investimento.

### Documentazione tecnica

Sul nostro sito web è possibile consultare le Schede Tecniche e i Certificati rilasciati da laboratori esterni per certificare tutti i nostri prodotti.

### Assistenza tecnica

Risposta rapida ed efficace, per telefono e/o per e-mail, ai dubbi e alle domande tecniche dei nostri clienti prima dell'acquisto, durante e dopo l'installazione, grazie al nostro servizio assistenza post-vendita.

### Consulenza in progetti

Il nostro team di ingegneri è a disposizione del cliente per analizzare le sue richieste, studiare le sue esigenze di illuminazione e guidarlo nella definizione finale del suo progetto con una consulenza specifica e mediante la gestione completa dello stesso. Aiutiamo a trasformare le sue idee in progetti con ogni sorta di studi e relazioni.

## Sales service

ThreeLine Technology S.L.'s sales department provides customers with a personal service from start to finish. Our in-house sales representatives distributed by geographical areas will immediately assist you throughout the order management process: from stock or price queries to tracking materials after dispatch.

Our friendly and personal customer service prides itself on exceeding customers' expectations and making sure they buy the appropriate product according to their needs, their orders arrive as soon as possible, and the products are correctly set up.

### Order Tracking

Our customers can easily track and trace their domestic or international shipments online, using the tracking number provided by the courier companies with which we work.

## Logistics hub

Our logistic centre has over 3,000 square metres of warehouse space, spread over 5 facilities, where our vast array of products are stored, so we can deliver customers' orders to the right place at the right time.

## Product Categories



Outstanding quality  
Alta qualità



Quality at the best price  
Qualità al miglior prezzo



Affordable for everyone  
A portata di tutti

## Servizio clienti

L'Ufficio Vendite di ThreeLine Technology S.L. offre ai nostri clienti un servizio personalizzato in tutti gli ordini. I nostri rappresentanti di commercio interni distribuiti per zone ti offriranno consulenza immediata in tutto il processo di gestione degli ordini, dal controllo dello stock o dei prezzi al tracking dei materiali, una volta spedito dai nostri magazzini.

L'Ufficio Assistenza Clienti offre un servizio personalizzato basato sulla cortesia e la cordialità per far sì che i nostri clienti ottengano il prodotto giusto per le loro esigenze, nel più breve tempo possibile e assicurandosi un corretto uso dello stesso.

### Tracking delle spedizioni

I nostri clienti possono seguire online, in tempo reale, lo stato delle spedizioni, sia nazionali che internazionali, in modo chiaro e veloce, grazie al numero di tracking fornito dalle diverse società di trasporto con cui lavoriamo.

## Centro logistico

Con più di 3.000 m2 di magazzino logistico, divisi in 5 strutture, mettiamo a disposizione dei nostri clienti un gran numero di stock del nostro vasto catalogo di prodotti, con diverse finiture, opzioni e personalizzazioni; offrendogli la possibilità di consegnargli l'ordine nel più breve tempo possibile e nel modo più efficace.

## Categorie di prodotti



# BASIC TECHNICAL LIGHTING CONCEPTS.

## CONCETTI BASE DI ILLUMINOTECNICA.



### CCT Correlated colour temperature

The colour appearance of the light emitted by a source as perceived by the human eye. Warm lights are dominated by amber and cool lights by blue. CCT is measured in kelvins (K) and refers to the temperature reached by a black body when heating up to give out the same light as the luminous source.

### CCT Temperatura di colore correlata

La sensazione di colore percepita dall'occhio umano davanti a una luce. Nel caso dei colori caldi predomina l'ambra, in quello dei colori freddi il blu. Si misura in gradi Kelvin (K) ed è correlata alla temperatura alla quale il corpo nero, riscaldato, presenta un aspetto di colore simile.



### CRI Colour Rendering Index

A scale from 0 to 100 that indicates how accurate a light source is at rendering colour when compared to a natural light source, such as daylight.

### CRI Indice di Resa Cromatica

Misura, su una scala da 0 a 100, la capacità di una sorgente luminosa di riprodurre fedelmente i colori di un oggetto rispetto a una sorgente di luce naturale o reale (sole).

CRI of 90 to 100: Excellent colour rendering. Specialised indoor uses.

CRI of 80 to 89: Good colour rendering. Indoor use.

CRI of 70 to 79: Average colour rendering. Outdoor use.

CRI lower than 70: Low colour rendering. Unusual for LED.

90 <math>Ra \le 100</math> Molto efficiente: Applicazioni speciali indoor.

80 <math>Ra \le 90</math> Efficiente: Indoor.

70 <math>Ra \le 80</math> Normale: Outdoor.

Ra <math>Ra < 70</math> Scarsa: Inusuale nel LED.

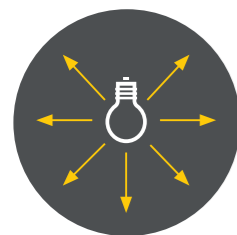

### Luminous flux

Measured in lumens (lm), the luminous flux of a light source is the total power emitted in all directions as radiation visible to the eye.

### Flusso luminoso

Si misura in lumen (lm) ed è la potenza emessa dalla sorgente luminosa, in tutte le direzioni dello spazio, sotto forma di radiazione luminosa sensibile all'occhio umano.

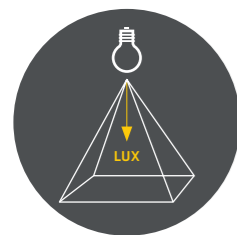

### Illuminance

The total luminous flux incident on a surface, per piece area, and is measured in lux (lm/m<sup>2</sup>).

### Illuminamento

Si misura in lux (lm/m<sup>2</sup>) ed è la densità della luce su una superficie, ossia misura la quantità di flusso luminoso per pece di superficie.



### Flicker

Flicker is the name given to changing light intensity caused by fluctuations in the power fed into the LED. These fluctuations are produced as the driver input alternating current is not properly rectified.

Exposure to high frequency flicker may cause annoyance, distraction and trigger serious ailments, such as headaches and even epileptic seizures.

Low-frequency flicker guarantees visual comfort, which has an impact on safety and labour productivity.

### Flicker

Si tratta di un fenomeno legato a variazioni rapide della corrente elettrica che alimenta i LED. Queste variazioni sono causate da una cattiva trasmissione della corrente alternata del driver.

Se il driver presenta un'alta percentuale di flicker, può causare irritazione, distrazione e problemi di salute come mal di testa e persino crisi epilettiche alle persone esposte alle lampade.

Con un livello di flicker ridotto o inesistente, si garantisce un comfort visivo che migliora la sicurezza e la produttività del lavoro.

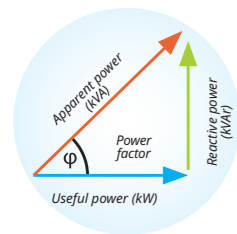

### Power Factor

It measures the efficiency of power consumption when converting this consumption into useful energy; in this case, light.

PF=Actual working power / total power consumed

The closer to 1, the better the PF.

### Fattore di potenza

Misura l'efficienza del consumo energetico quando si trasforma in energia utile; in questo caso, in luce.

FP="Potenza reale di lavoro" / "Potenza totale consumata"

Quanto più vicino a 1 è il valore, migliore sarà il FP.



### IP Rating

Used to define levels of sealing effectiveness of electrical enclosures against intrusion from foreign bodies (tools, dirt, etc.) and moisture.

These ratings are defined in the following standard, which also indicates how to perform the verification tests:

UNE 20324, equivalent to European standard EN 60529.

### Grado IP

Indica i gradi di protezione di un involucro contro l'intrusione di particelle solide e acqua.

Tutti questi codici sono descritti in una norma, in cui viene inoltre indicato come eseguire i test per la loro verifica:

UNE 20324, che equivale alla norma europea EN 60529.

### IPXX

#### 1st: Foreign body and dust protection

1ª cifra: Protezione contro oggetti e polvere

- 0** No protection. Nessuna protezione.
- 1** Against foreign bodies  $\geq 50$  mm. Protezione contro oggetti di diametro superiore a 50 mm.
- 2** Against foreign bodies  $\geq 12$  mm. Protezione contro oggetti di diametro superiore a 12 mm.
- 3** Against foreign bodies  $\geq 2.5$  mm. Protezione contro oggetti di diametro superiore a 2,5 mm.
- 4** Against foreign bodies  $\geq 1$  mm. Protezione contro oggetti di diametro superiore a 1 mm.
- 5** Dust-protected. Protezione contro la polvere.
- 6** Dust-tight. A tenuta di polvere.

### IPXX

#### 2nd: Water protection

2ª cifra: Protezione contro i liquidi

- 0** No protection. Nessuna protezione.
- 1** Against dripping water. Protezione contro gocce d'acqua.
- 2** Against dripping water with a 15-degree tilt. Protezione contro gocciolamento d'acqua con inclinazione di 15 gradi.
- 3** Against spraying water. Protezione contro la pioggia.
- 4** Against water splash. Protezione contro gli spruzzi d'acqua.
- 5** Against water jets. Protezione contro i getti d'acqua.
- 6** Against powerful water jets. Protezione contro potenti getti d'acqua.
- 7** Against temporary immersion. Protezione contro gli effetti dell'immersione temporanea.
- 8** Against continuous immersion. Protezione contro gli effetti dell'immersione continua.



### Luminous efficacy

The efficiency of a light source, the quotient of the luminous flux (lm) emitted divided by the electrical power (W) consumed. Reported in lumens per Watt (lm/W). The higher the values, the better.

### Efficienza

Rapporto tra la quantità di luce emessa (lm) e la potenza (W) consumata, per questo la sua pece di misura è lm/W. L'obiettivo è raggiungere i valori più alti possibili.

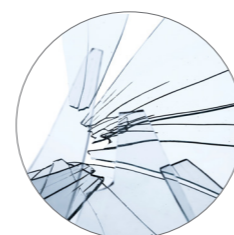

### IK Rating

Used to define levels of sealing effectiveness of electrical enclosures against external mechanical impacts to protect internal materials and devices.

These ratings are defined in the following standard, which also indicates how to perform the verification tests:

UNE-EN 50102 standard.

IK CODES (EN 50102)	01	02	03	04	05	06	07	08	09	10
HEIGHT (cm)	7,5	10	17	25	35	20	40	29,5	20	40
IMPACT ENERGY (J)	0,15	0,20	0,35	0,50	0,70	1	2	5	10	20





## WHAT IS CASAMBI?

It is an advanced control system based on Bluetooth Low Energy (BLE). Casambi is a state-of-the-art wireless technology and the only low power wireless technology in all modern smartphones, tablets and even smart watches since 2012.

Casambi technology can also be easily integrated into luminaires and drivers creating an optimal solution in terms of ease of installation and functionality with minimal deployment costs.

This system provides a mesh network where all the intelligence of the system is replicated in every node.

## COS'È CASAMBI?

Si tratta di un avanzato sistema di controllo basato sulla tecnologia Bluetooth Low Energy (BLE). Casambi è un'applicazione wireless avanzata e l'unica a basso consumo integrata in tutti i nuovi smartphone, tablet e smartwatch a partire dal 2012.

La tecnologia Casambi può essere integrata in corpi illuminanti e driver e rappresenta una soluzione ottimale per facilità di installazione e funzionalità, con costi minimi.

Questo sistema fornisce una rete in cui tutta l'intelligenza del sistema viene replicata in ogni nodo.

## EASY TO USE

Casambi is a very intuitive system made both for the consumer market as well as the professional market.

The app is free to download and it is available in Google play and App Store.

Connect it to the luminaire, pair it to the phone and it will be ready without any professional help.

## FACILE DA UTILIZZARE

Casambi è un sistema progettato sia per uso privato sia per il mercato professionale. Rappresenta quindi una soluzione facile ed intuitiva per tutti.

Il download dell'APP è gratuito ed è disponibile su Google Play e sull'App Store Apple.

Una volta connesso al corpo illuminante e associato con il dispositivo, è pronto, senza necessità di essere configurato da un professionista.



## FEATURES

1. Compatible with all the new smartphones, tablets and smartwatches.
2. The system is on constant synchronisation.
3. It is only connected when necessary.
4. It allows up to 250 devices in a net.
5. Unlimited number of scenes and animations.
6. Different access levels.
7. Versatile customizable software.
8. Maximum range between nodes: 30 m (depending on the obstacles).

## CARATTERISTICHE

1. Compatibile con tutti i nuovi smartphone, tablet e smartwatch.
2. Il sistema è in sincronizzazione costante.
3. Si connette solamente quando è necessario.
4. Possibilità di collegare fino a 250 dispositivi sulla stessa rete.
5. Numero illimitato di scenari e animazioni.
6. Differenti livelli di accesso.
7. Versatilità nel cambio di configurazione dell'installazione.
8. Distanza massima tra i nodi: 30 m (a seconda degli ostacoli).

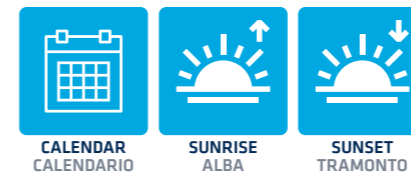
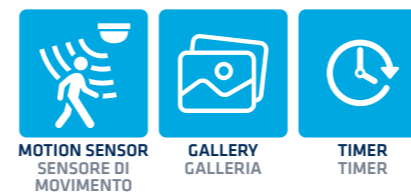

## FUNCTIONS

- Dimming light and adjusting colour temperature.
- Grouping all the luminaires, switching them on and off and dimming them all together or they can be opened for individual control.
- Creating, saving and repeating scenes and animations.
- Using the timer to turn on and off scenes and animations based on a convenient time and date.
- Taking photos of a space, and marking the positions of the luminaires on them.
- Matching the timers to the local sunrise and sunset times.

## FUNZIONI

- Attenuare la luminosità e regolare la temperatura di colore.
- Raggruppare i corpi illuminanti e accendere, spegnere e attenuare la luminosità in gruppo o singolarmente.
- Configurare, salvare e recuperare scenari e animazioni.
- Utilizzare il timer per attivare e disattivare scenari e animazioni basati su data e ora.
- Fare foto degli spazi e aggiungervi direttamente il controllo dei corpi illuminanti.
- Regolare i timer in funzione dell'alba e del tramonto.



## LOCAL ACCESS

Internet connection is not necessary for a proper functioning, the communication is made through BLE (Bluetooth Low Energy).

La comunicazione tra dispositivi avviene attraverso il BLE (Bluetooth Low Energy) e non è necessario avere connessione a internet per farla funzionare.

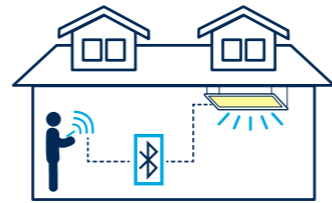

## REMOTE ACCESS

It is possible to control multiple luminaires remotely through Internet by using a gateway. A network administrator can also configure the net remotely.

È possibile controllare i corpi illuminanti a distanza tramite internet, utilizzando un "Gateway". Anche un amministratore di rete può configurarla da remoto.



## GATEWAY

A smartphone and tablet with Internet connection within the BLE scope of some of the luminaires is necessary to the remote control.

Per il controllo remoto è necessario tenere sempre uno smartphone o tablet connesso a Internet all'interno della portata del BLE dei corpi illuminanti.

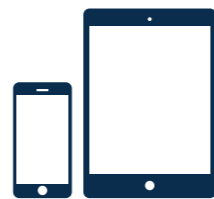

## DEVICES / DISPOSITIVI



## LUMINAIRES DIMMING BY CASAMBI

### REGOLAZIONE DI CORPI ILLUMINANTI TRAMITE CASAMBI



When a product shows this symbol, that means that the original driver of the product can be changed for a compatible CASAMBI driver.

Nei prodotti che riportano questo simbolo è possibile sostituire il driver originale del prodotto con un driver compatibile con CASAMBI.

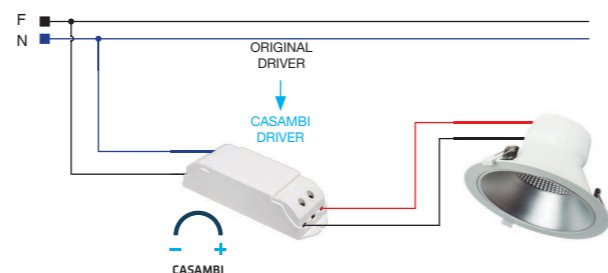

## SMART HOME CONTROLLER

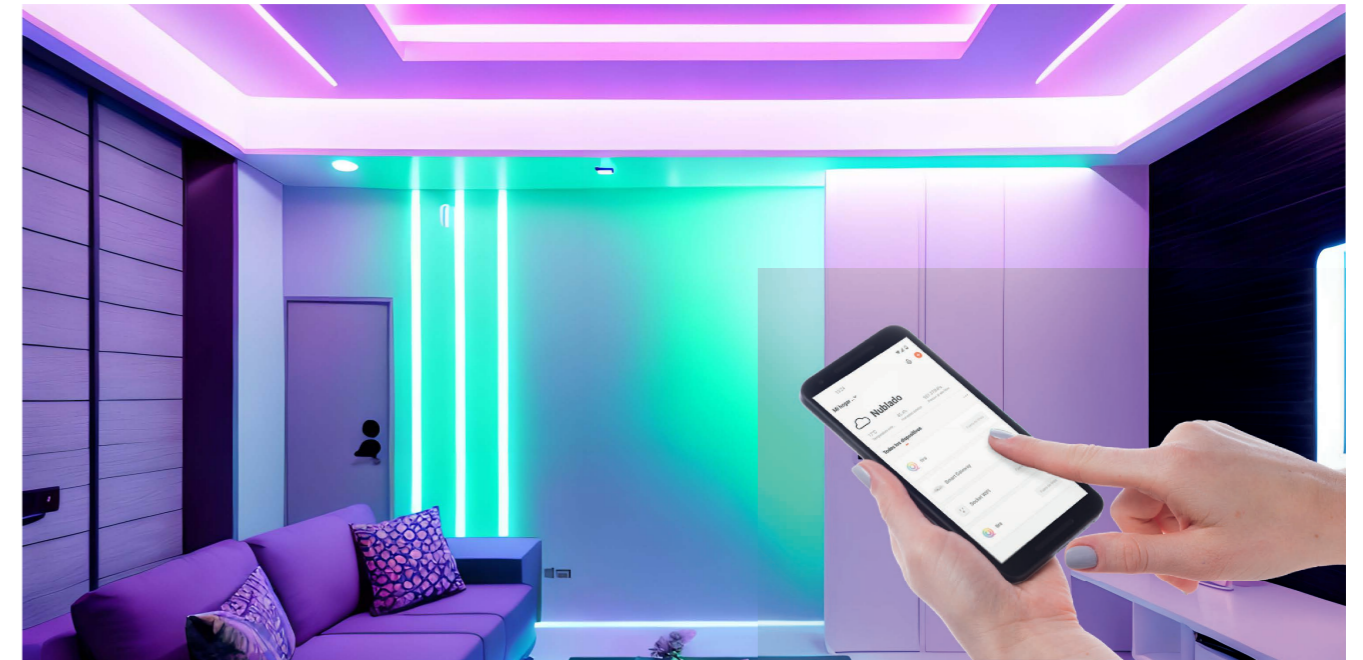

## WHAT IS SMART HOME?

Smart Home is a home that incorporates a system allowing the automation of tasks. Its main objective is to improve people's lives and to promote an efficient use of resources, reducing both home expenses as well as the resources themselves.

Smart lighting incorporates many technologies to make indoor and outdoor LED strips work automatically under certain conditions. Control can be carried out both in person and remotely, thanks to smartphones and internet connection.

Its main advantages are remote home lighting management, energy savings and increased efficiency of the devices.

## EASY TO USE

Smart Home is an intuitive and very simple system designed for use in the home. It is managed through a free downloadable APP.

It connects to the LED strips, synchronises with the phone and does not require configuration by a professional.

## FUNCTIONS

- Power on/off by remote control
- Voice control
- On/off programming
- Dimming the intensity and light colour
- Setting different atmospheres in each part of the house
- Automatic lighting
- Synchronising music with light

## COS'È UNA SMART HOME?

Il termine Smart Home (Casa Intelligente) sta a indicare lo studio e l'applicazione di tecnologie in grado di automatizzare una serie di attività e processi con l'obiettivo di migliorare la qualità della vita, aumentare il comfort e ridurre i consumi di un impianto tanto in contesti domestici quanto lavorativi.

Una delle principali risposte a queste necessità si chiama Smart Lighting (Illuminazione intelligente), ovvero l'insieme delle nuove tecnologie di illuminazione rivolte al benessere, al comfort visivo, alla sicurezza, alla versatilità e al risparmio energetico. Tra le nuove sorgenti luminose intelligenti si annoverano senza dubbio le strip LED che, se progettate in un impianto smart, grazie alle nuove tecnologie IoT possono essere completamente gestite da remoto, comunicando tra di loro e perfino scambiando segnali e dati con altri dispositivi e oggetti.

I principali vantaggi risiedono appunto nella gestione dell'illuminazione domestica a distanza, nel risparmio energetico e nell'aumento dell'efficienza dei dispositivi.

## FACILE DA USARE

Smart Home è un sistema intuitivo e molto semplice, pensato per un utilizzo domestico. La gestione avviene attraverso una APP scaricabile gratuitamente.

Si connette alle strip LED, si sincronizza con qualsiasi smartphone e non è necessaria la configurazione da parte di un professionista.

## FUNZIONI

- Accensione e spegnimento da remoto
- Controllo vocale
- Programmazione di accensione e spegnimento
- Regolazione dell'intensità della luce
- Configurazione di diversi ambienti in ogni zona di casa
- Illuminazione automatica
- Sincronizzazione della luce con la musica

CREATION OF LED STRIPS REFERENCES.  
 CREAZIONE CODICI STRIP LED.



CREATION OF PROFILES REFERENCES.  
 CREAZIONE CODICI PROFILI.



**NAME**  
 ST STRAK  
 NF NEON FLEX

**POWER**  
 48 4,8 W/m  
 05 5 W/m  
 72 7,2 W/m  
 77 7,7 W/m  
 96 9,6 W/m  
 10 10 W/m  
 12 12 W/m  
 13 13 W/m  
 14 14,4 W/m  
 15 15 W/m  
 17 16,8 W/m  
 18 18 W/m  
 19 19,2 W/m

**TYPE OF STRIP**  
**STRAK**  
 X High Efficiency  
 H High Performance  
 T Thin  
 L Side-Emitting  
 S S-shaped  
 C COB  
 W Dim-to-Warm  
 R RGB  
 D Digital  
**NEON FLEX**  
 F Top-View  
 S Smooth Line  
 L Side-Emitting  
 C 360° Round

**IP**  
 2 IP20  
 6 IP65

**ANGLE**  
 VL 120°  
 36 360°

**CCT**  
 1 2200K ●  
 2 2700K ●  
 3 3000K ●  
 4 4000K ●  
 6 6000K ●  
 R RGB ●●●  
 B Two-Colour ●●  
 B Dim-to-Warm ●●  
 B Tunable White ●●

**LENGTH**  
 0 5 m Reel  
 M 1 m Cutting  
 1 10 m Reel  
 3 30 m Reel  
 5 50 m Reel

**ST14X23VLO**

Add **CL** to create the reference for the CLIPS.  
 Aggiungere **CL** per generare il codice delle CLIP.

Add **TA** to create the reference for the CAPS.  
 Aggiungere **TA** per generare il codice dei TAPPI.

Product indicator **PROFILES**.  
 Indicatore di prodotto **PROFILI**.

Measures of the **PROFILE** section.  
 Misura della sezione del **PROFILO**.

Add **CM** to indicate cut-to-size.  
 Aggiungere **CM** per indicare taglio su misura.

**FINISHING**  
 AN Anodised  
 NE Black  
 BL White

**TYPE OF PROFILE**

	Description	Comercial name
<b>SP</b>	Surface	TIBER
<b>SC</b>	Curved Surface	BENI
<b>EM</b>	Recessed	NILE
<b>CL</b>	Suspension - Surface	LEAN
<b>AR</b>	Architectural	ACRE
<b>EQ</b>	Corners	KONDA
<b>EL</b>	Staircase - Corner	RENO
<b>SL</b>	Floor	SELE
<b>PD</b>	Wall	EBRO
<b>TB</b>	Tubes	OKOA
<b>RD</b>	Skirting Board	GANGES
<b>CH</b>	Heat Sink Plates	DAO

**CLTA PF1414SPCM AN**

# LED Strips *Strip LED*

Cut to size / *Taglio su misura*

Different applications / *Diverse applicazioni*

IP65 LED Strips / *Strip LED IP65*

Dimming / *Regolazione*

## Lighting

Threeline has a wide range of LED strips for a complete and professional solution focused on offering modern, decorative, linear lighting. Strips can be cut to size to suit the requirements of any domestic, professional or commercial installation.

LED strips that change colour and intensity provide modern and functional environments, adapting the facilities to different uses and times, and this can be achieved with different control options. All our strips can be controlled independently.

With the advice of our technical department, you will be able to choose the best option.

*Noi di Threeline offriamo un'ampia varietà di strip LED, che rappresentano una soluzione completa e professionale quando c'è da proporre un'illuminazione moderna, decorativa e lineare. Le strip LED possono essere tagliate su misura per adattarsi a impianti in qualsiasi ambito: residenziale, professionale o commerciale.*

*Le strip LED con variazione di colore e intensità rendono gli ambienti più moderni e confortevoli alla vista, modificando la loro destinazione d'uso a seconda delle esigenze o del momento, grazie alle opzioni di controllo. Tutte le nostre strip LED possono essere controllate in maniera indipendente.*

*Con il supporto del nostro Ufficio Tecnico potrai scegliere la soluzione migliore per te.*

# LED Strips *Strip LED*

Cut to size / *Taglio su misura*

Different applications / *Diverse applicazioni*

IP65 LED Strips / *Strip LED IP65*

Dimming / *Regolazione*

## Lighting

Threeline has a wide range of LED strips for a complete and professional solution focused on offering modern, decorative, linear lighting. Strips can be cut to size to suit the requirements of any domestic, professional or commercial installation.

LED strips that change colour and intensity provide modern and functional environments, adapting the facilities to different uses and times, and this can be achieved with different control options. All our strips can be controlled independently.

With the advice of our technical department, you will be able to choose the best option.

*Noi di Threeline offriamo un'ampia varietà di strip LED, che rappresentano una soluzione completa e professionale quando c'è da proporre un'illuminazione moderna, decorativa e lineare. Le strip LED possono essere tagliate su misura per adattarsi a impianti in qualsiasi ambito: residenziale, professionale o commerciale.*

*Le strip LED con variazione di colore e intensità rendono gli ambienti più moderni e confortevoli alla vista, modificando la loro destinazione d'uso a seconda delle esigenze o del momento, grazie alle opzioni di controllo. Tutte le nostre strip LED possono essere controllate in maniera indipendente.*

*Con il supporto del nostro Ufficio Tecnico potrai scegliere la soluzione migliore per te.*



Page



CCT

CRI



LEDs/m

24 Vdc

Category	Product	Model	Power (W/m)	IP Rating	CCT	CRI	Beam Spread	Efficiency (lm/W)	Height (mm)	LEDs/m	
HIGH EFFICIENCY SINGLE-COLOUR	STRAK X	ST96X2 / ST96X6	9,6 W/m	IP20 / IP65	2200K - 6000K	> 80	1477 ~ 1734 lm/m	154 ~ 181 lm/W	10 / 12 mm	80	
		ST14X2 / ST14X6	14,4 W/m	IP20 / IP65	2200K - 6000K	> 80	2093 ~ 2260 lm/m	145 ~ 157 lm/W	10 / 12 mm	80	
		ST18X2 / ST18X6	18 W/m	IP20 / IP65	2200K - 6000K	> 80	2625 ~ 2958 lm/m	146 ~ 164 lm/W	10 / 12 mm	160	
HIGH CRI SINGLE-COLOUR	STRAK H	ST48H2 / ST48H6	4,8 W/m	IP20 / IP65	2200K - 6000K	> 95	600 ~ 705 lm/m	125 ~ 147 lm/W	8 / 10 mm	80	
		ST96H2 / ST96H6	9,6 W/m	IP20 / IP65	2200K - 6000K	> 95	921 ~ 1255 lm/m	96 ~ 131 lm/W	8 / 10 mm	140	
		ST14H2 / ST14H6	14,4 W/m	IP20 / IP65	2200K - 6000K	> 95	1700 ~ 1891 lm/m	118 ~ 131 lm/W	10 / 12 mm	182	
		ST19H2 / ST19H6	19,2 W/m	IP20 / IP65	2200K - 6000K	> 95	2626 ~ 2893 lm/m	137 ~ 151 lm/W	10 / 12 mm	240	
SPECIAL SINGLE-COLOUR	STRAK T	ST96T2	9,6 W/m	IP20	2200K - 6000K	> 90	960 ~ 1050 lm/m	100 ~ 109 lm/W	4 mm	192	
		STRAK L	ST12L2 / ST12L6	12 W/m	IP20 / IP65	2200K - 6000K	> 80	1105 ~ 1200 lm/m	92 ~ 100 lm/W	8,5 mm	120
		STRAK S	ST96S2	9,6 W/m	IP20	2200K - 6000K	> 80	990 ~ 1000 lm/m	103 ~ 104 lm/W	7 mm	120
COB	STRAK C	ST05C2 / ST05C6	5 W/m	IP20 / IP65	2200K - 6000K	> 90	475 ~ 550 lm/m	95 ~ 110 lm/W	8 / 11 mm	480	
		ST10C2 / ST10C6	10 W/m	IP20 / IP65	2200K - 6000K	> 90	918 ~ 1147 lm/m	92 ~ 115 lm/W	8 / 11 mm	480	
		ST18C2	18 W/m	IP20	2200K - 6000K	> 90	1483 ~ 1713 lm/m	82 ~ 95 lm/W	10 mm	546	
		ST13C2R	13 W/m	IP20	2200K - 6000K	> 90	44 lm/m	3 lm/W	10 mm	672	
TWO-COLOUR	STRAK HB	ST96H2B / ST96H6B	9,6 W/m	IP20 / IP65	2200K - 6000K	> 80	670 ~ 780 lm/m	70 ~ 81 lm/W	10 / 10,5 mm	60	
		ST10H2B / ST10H6B	9,6 W/m	IP20 / IP65	2200K - 6000K	> 80	600 ~ 720 lm/m	63 ~ 75 lm/W	10 / 10,5 mm	120	
		ST19H2B / ST19H6B	19,2 W/m	IP20 / IP65	2200K - 6000K	> 80	2119 ~ 2458 lm/m	110 ~ 128 lm/W	10 / 10,5 mm	112	
DIM TO WARM	STRAK WB	ST12W2B / ST12W6B	12 W/m	IP20 / IP65	2200K - 6000K	> 80	34 ~ 1435 lm/m	3 ~ 120 lm/W	10 / 12 mm	168	
RGB	STRAK XR	ST14X2R / ST14X6R	14,4 W/m	IP20 / IP65	RGB	> 80	443 ~ 466 lm/m	31 ~ 32 lm/W	10 / 12 mm	60	
RGB W	STRAK HR	ST14H2R	14,4 W/m	IP20	RGB	> 80	493 lm/m	34 lm/W	8 mm	120	
RGB TW	STRAK R3	ST14R23 / ST14R63	14,4 W/m	IP20 / IP65	RGB + CCT	> 80	712 ~ 747 lm/m	99 ~ 104 lm/W	10 / 12 mm	120	
DIGITAL RGB	STRAK DR	ST14D6R	14,4 W/m	IP65	RGB	> 80	—	—	12 mm	60	
STRAK D6		ST19D66	19,2 W/m	IP65	RGB + CCT	> 80	751 lm/m	39 lm/W	12 mm	60	
NEON FLEX	NEON SMOOTH LINE	NEON TOP	NF72F6	7,2 W/m	IP65	2200K - 6000K	> 80	622 ~ 662 lm/m	86 ~ 92 lm/W	6,5 mm	210
		NEON	NF15S6	15 W/m	IP65	2200K - 6000K	> 80	1870 ~ 2040 lm/m	125 ~ 136 lm/W	7 mm	238
		NEON SIDE	NF15S6R	15 W/m	IP65	RGB	> 80	560 lm/m	37 lm/W	10 mm	168
		NEON SIDE	NF77L6	7,7 W/m	IP65	2200K - 6000K	> 80	405 ~ 426 lm/m	53 ~ 55 lm/W	6 mm	128
		NEON SIDE	NF14L6R	14,4 W/m	IP65	RGB	> 80	66 lm/m	5 lm/W	6 mm	120
		NEON 360°	NF12C6	12 W/m	IP65	2200K - 6000K	> 80	1430 ~ 1500 lm/m	119 ~ 125 lm/W	20 mm	256
		NEON 360°	NF12C6R	12 W/m	IP65	RGB	> 80	330 lm/m	28 lm/W	30 mm	240



LED STRIPS / STRIP LED

PROFILES / PROFILI

CONTROLLERS / CONTROLLATORI

POWER SUPPLIES / ALIMENTATORI

## STRAK X ST96X2 / ST96X6

Up to  
181 lm/W

- 9,6 W/m
- SMD2835
- 80 LEDs/m
- 100 mm
- 3 SDCM



High efficiency single-colour LED strip / Strip LED monocolor alta efficienza

- 24Vdc
- 3000K
- 4000K
- 6000K
- CRI >80
- 5 YEARS OF WARRANTY

Cut to size  
Taglio su misura

### • IP20 ACCESSORIES

#### STRIP-TO-STRIP CONNECTION

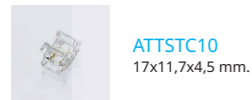

#### STRIP-TO-POWER SUPPLY CONNECTION

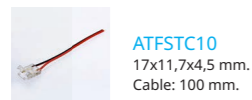

#### STRIP-TO-STRIP CONNECTION WITH CABLE

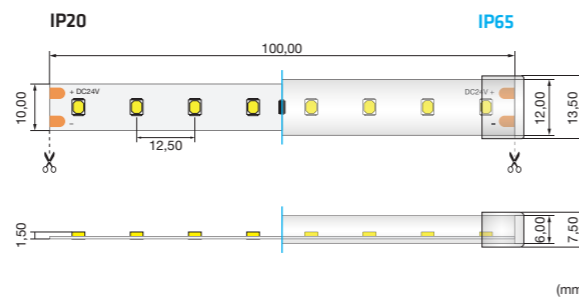

### • IP65 ACCESSORIES

#### END CAP



#### END CAP WITH HOLE



5 m	50 m	CCT	IP	W/m	lm/m	lm/W
ST96X23VLO	ST96X23VL5	ST96X23VLM	● 3000K	IP20	9,6 W/m	1560 lm/m 163 lm/W
ST96X24VLO	ST96X24VL5	ST96X24VLM	● 4000K	IP20	9,6 W/m	1734 lm/m 181 lm/W
ST96X26VLO	ST96X26VL5	ST96X26VLM	● 6000K	IP20	9,6 W/m	1627 lm/m 169 lm/W
ST96X63VLO	ST96X63VL5	ST96X63VLM	● 3000K	IP65	9,6 W/m	1477 lm/m 154 lm/W
ST96X64VLO	ST96X64VL5	ST96X64VLM	● 4000K	IP65	9,6 W/m	1555 lm/m 162 lm/W
ST96X66VLO	ST96X66VL5	ST96X66VLM	● 6000K	IP65	9,6 W/m	1532 lm/m 160 lm/W

5 m IP65 reel includes:  
2 pcs TST6712S and 2 pcs TST6712C.

Which measure do you need? Contact us!  
Di che misura hai bisogno? Contattaci!

## STRAK X ST14X2 / ST14X6

Up to  
157 lm/W

- 14,4 W/m
- SMD2835
- 80 LEDs/m
- 100 mm
- 3 SDCM



High efficiency single-colour LED strip / Strip LED monocolor alta efficienza

- 24Vdc
- 2700K
- 3000K
- 4000K
- 6000K
- CRI >80
- 5 YEARS OF WARRANTY

Cut to size  
Taglio su misura

### • IP20 ACCESSORIES

#### STRIP-TO-STRIP CONNECTION



#### STRIP-TO-POWER SUPPLY CONNECTION



#### STRIP-TO-STRIP CONNECTION WITH CABLE

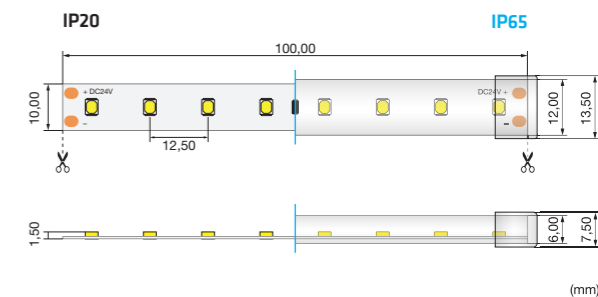
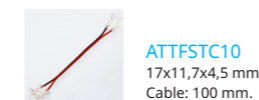

### • IP65 ACCESSORIES

#### END CAP



#### END CAP WITH HOLE



5 m	50 m	CCT	IP	W/m	lm/m	lm/W
ST14X22VLO	ST14X22VL5	ST14X22VLM	● 2700K	IP20	14,4 W/m	2240 lm/m 156 lm/W
ST14X23VLO	ST14X23VL5	ST14X23VLM	● 3000K	IP20	14,4 W/m	2220 lm/m 154 lm/W
ST14X24VLO	ST14X24VL5	ST14X24VLM	● 4000K	IP20	14,4 W/m	2260 lm/m 157 lm/W
ST14X26VLO	ST14X26VL5	ST14X26VLM	● 6000K	IP20	14,4 W/m	2260 lm/m 157 lm/W
ST14X62VLO	ST14X62VL5	ST14X62VLM	● 2700K	IP65	14,4 W/m	2120 lm/m 147 lm/W
ST14X63VLO	ST14X63VL5	ST14X63VLM	● 3000K	IP65	14,4 W/m	2093 lm/m 145 lm/W
ST14X64VLO	ST14X64VL5	ST14X64VLM	● 4000K	IP65	14,4 W/m	2120 lm/m 147 lm/W
ST14X66VLO	ST14X66VL5	ST14X66VLM	● 6000K	IP65	14,4 W/m	2148 lm/m 149 lm/W

5 m IP65 reel includes:  
2 pcs TST6712S and 2 pcs TST6712C.

Which measure do you need? Contact us!  
Di che misura hai bisogno? Contattaci!

# STRAK X ST18X2 / ST18X6

Up to  
164 lm/W

- 18 W/m
- SMD2835
- 160 LEDs/m
- 50 mm
- 3 SDCM



High efficiency single-colour LED strip / Strip LED monocore alta efficienza

- 24Vdc
- 3000K
- 4000K
- 6000K
- CRI >80
- 5 YEARS OF WARRANTY



## • IP20 ACCESSORIES

### STRIP-TO-STRIP CONNECTION

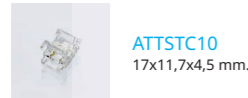

### STRIP-TO-POWER SUPPLY CONNECTION



### STRIP-TO-STRIP CONNECTION WITH CABLE

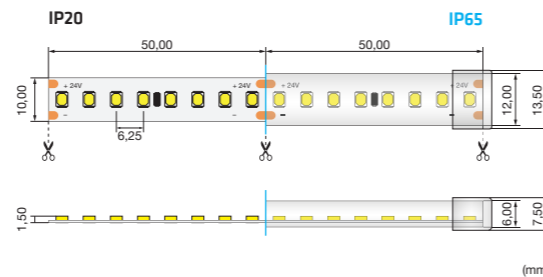

## • IP65 ACCESSORIES

### END CAP

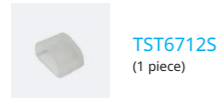

### END CAP WITH HOLE



5 m	50 m	CCT	IP	W/m	lm/m	lm/W	
ST18X23VLO	ST18X23VL5	ST18X23VLM	3000K	IP20	18 W/m	2785 lm/m	155 lm/W
ST18X24VLO	ST18X24VL5	ST18X24VLM	4000K	IP20	18 W/m	2927 lm/m	163 lm/W
ST18X26VLO	ST18X26VL5	ST18X26VLM	6000K	IP20	18 W/m	2958 lm/m	164 lm/W
ST18X63VLO	ST18X63VL5	ST18X63VLM	3000K	IP65	18 W/m	2625 lm/m	146 lm/W
ST18X64VLO	ST18X64VL5	ST18X64VLM	4000K	IP65	18 W/m	2651 lm/m	147 lm/W
ST18X66VLO	ST18X66VL5	ST18X66VLM	6000K	IP65	18 W/m	2736 lm/m	152 lm/W

5 m IP65 reel includes:  
2 pcs TST6712S and 2 pcs TST6712C.

Which measure do you need? Contact us!  
Di che misura hai bisogno? Contattaci!



IP20

IP20 LED strip designed for indoor use, perfect to obtain a diffused lighting both at home and in commercial establishments.

Strip LED IP20 concepita per interni, ideale per ottenere un'illuminazione diffusa, sia in casa che in esercizi commerciali.



IP65

This IP65 LED strip is suitable if there is a constant presence of water and humidity, such as in bathrooms, kitchens, patios and terraces.

Questa strip LED IP65 è indicata nel caso in cui ci sia costante presenza di acqua e umidità, come bagni, cucine, patii e terrazzi.





# STRAK H ST48H2 / ST48H6

Up to  
147 lm/W

- 4,8 W/m
- SMD2835
- 80 LEDs/m
- 100 mm
- 3 SDCM



High CRI single-colour LED strip / Strip LED monocolor alto CRI

- 24Vdc
- 2200K
- 2700K
- 3000K
- 4000K
- 6000K
- CRI>95
- 5 YEARS OF WARRANTY



## • IP20 ACCESSORIES

### STRIP-TO-STRIP CONNECTION

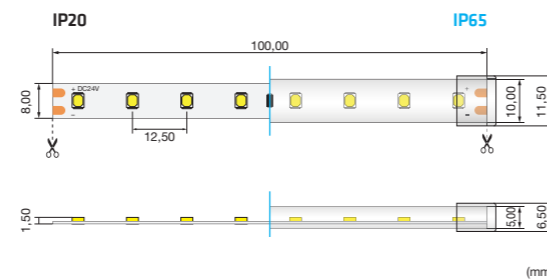
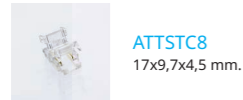

### STRIP-TO-POWER SUPPLY CONNECTION

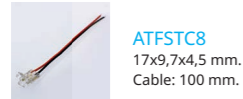

### STRIP-TO-STRIP CONNECTION WITH CABLE



## • IP65 ACCESSORIES

### END CAP



### END CAP WITH HOLE



5 m	50 m	CCT	IP	W/m	lm/m	lm/W	
ST48H21VL0	—	ST48H21VLM	2200K	IP20	4,8 W/m	630 lm/m	131 lm/W
ST48H22VL0	ST48H22VL5	ST48H22VLM	2700K	IP20	4,8 W/m	640 lm/m	133 lm/W
ST48H23VL0	ST48H23VL5	ST48H23VLM	3000K	IP20	4,8 W/m	691 lm/m	144 lm/W
ST48H24VL0	ST48H24VL5	ST48H24VLM	4000K	IP20	4,8 W/m	702 lm/m	146 lm/W
ST48H26VL0	ST48H26VL5	ST48H26VLM	6000K	IP20	4,8 W/m	705 lm/m	147 lm/W
ST48H61VL0	—	ST48H61VLM	2200K	IP65	4,8 W/m	600 lm/m	125 lm/W
ST48H62VL0	ST48H62VL5	ST48H62VLM	2700K	IP65	4,8 W/m	606 lm/m	126 lm/W
ST48H63VL0	ST48H63VL5	ST48H63VLM	3000K	IP65	4,8 W/m	657 lm/m	137 lm/W
ST48H64VL0	ST48H64VL5	ST48H64VLM	4000K	IP65	4,8 W/m	666 lm/m	139 lm/W
ST48H66VL0	ST48H66VL5	ST48H66VLM	6000K	IP65	4,8 W/m	670 lm/m	140 lm/W

Which measure do you need? Contact us!  
Di che misura hai bisogno? Contattaci!

5 m IP65 reel includes:  
2 pcs TST6710S and 2 pcs TST6710C.



Highlight the colour of your food with a clear lighting, accompanied by a great resistance to water and dust, thanks to the IP65 rating.

Fai risaltare il colore dei tuoi alimenti con un'illuminazione nitida, che si accompagna a una grande resistenza all'acqua e alla polvere grazie al grado di tenuta stagna IP65.



PRD STRAK H ST96H2 / ST96H6

Up to  
131 lm/W

- 9,6 W/m
- SMD2835
- 140 LEDs/m
- 50 mm
- 3 SDCM



High CRI single-colour LED strip / Strip LED monocolor alto CRI

- 24Vdc
- 2200K
- 2700K
- 3000K
- 4000K
- CRI>95
- 5 YEARS OF WARRANTY



• IP20 ACCESSORIES

STRIP-TO-STRIP CONNECTION

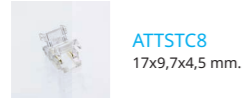

STRIP-TO-POWER SUPPLY CONNECTION

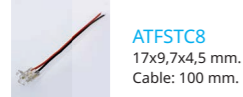

STRIP-TO-STRIP CONNECTION WITH CABLE

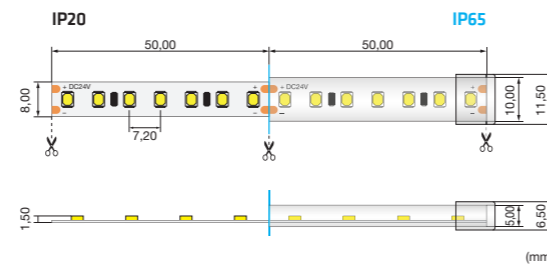

• IP65 ACCESSORIES

END CAP



END CAP WITH HOLE



5 m	50 m	CCT	IP	W/m	lm/m	lm/W
ST96H21VLO	—	ST96H21VLM ● 2200K	IP20	9,6 W/m	1145 lm/m	119 lm/W
ST96H22VLO	ST96H22VL5	ST96H22VLM ● 2700K	IP20	9,6 W/m	1158 lm/m	121 lm/W
ST96H23VLO	ST96H23VL5	ST96H23VLM ● 3000K	IP20	9,6 W/m	1190 lm/m	124 lm/W
ST96H24VLO	ST96H24VL5	ST96H24VLM ● 4000K	IP20	9,6 W/m	1255 lm/m	131 lm/W
ST96H61VLO	—	ST96H61VLM ● 2200K	IP65	9,6 W/m	921 lm/m	96 lm/W
ST96H62VLO	ST96H62VL5	ST96H62VLM ● 2700K	IP65	9,6 W/m	1104 lm/m	115 lm/W
ST96H63VLO	ST96H63VL5	ST96H63VLM ● 3000K	IP65	9,6 W/m	1130 lm/m	118 lm/W
ST96H64VLO	ST96H64VL5	ST96H64VLM ● 4000K	IP65	9,6 W/m	1149 lm/m	120 lm/W

Which measure do you need? Contact us!  
Di che misura hai bisogno? Contattaci!

5 m IP65 reel includes:  
2 pcs TST6710S and 2 pcs TST6710C.

# STRAK H ST14H2 / ST14H6

Up to  
131 lm/W

- 14,4 W/m
- SMD2835
- 182 LEDs/m
- 38,46 mm
- 3 SDCM



High CRI single-colour LED strip / Strip LED monocolor alto CRI

- 24Vdc
- 2700K
- 3000K
- 4000K
- CRI>95
- 5 YEARS OF WARRANTY

Cut to size  
Taglio su misura



LED STRIPS / STRIP LED

PROFILES / PROFILI

## • IP20 ACCESSORIES

### STRIP-TO-STRIP CONNECTION

**ATTSTC10**  
17x11,7x4,5 mm.

### STRIP-TO-POWER SUPPLY CONNECTION

**ATFSTC10**  
17x11,7x4,5 mm.  
Cable: 100 mm.

### STRIP-TO-STRIP CONNECTION WITH CABLE

**ATTFSTC10**  
17x11,7x4,5 mm.  
Cable: 100 mm.

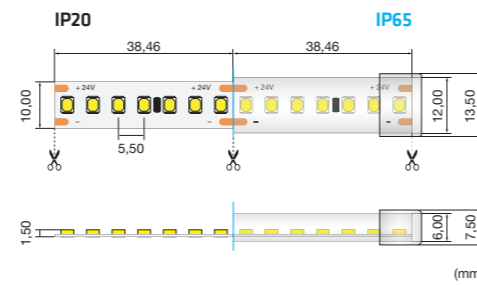

## • IP65 ACCESSORIES

### END CAP

**TST6712S**  
(1 piece)

### END CAP WITH HOLE

**TST6712C**  
(1 piece)

5 m	50 m	CCT	IP	W/m	lm/m	lm/W	
ST14H22VL0	ST14H22VL5	ST14H22VLM	2700K	IP20	14,4 W/m	1749 lm/m	121 lm/W
ST14H23VL0	ST14H23VL5	ST14H23VLM	3000K	IP20	14,4 W/m	1811 lm/m	126 lm/W
ST14H24VL0	ST14H24VL5	ST14H24VLM	4000K	IP20	14,4 W/m	1891 lm/m	131 lm/W
ST14H62VL0	ST14H62VL5	ST14H62VLM	2700K	IP65	14,4 W/m	1700 lm/m	118 lm/W
ST14H63VL0	ST14H63VL5	ST14H63VLM	3000K	IP65	14,4 W/m	1723 lm/m	120 lm/W
ST14H64VL0	ST14H64VL5	ST14H64VLM	4000K	IP65	14,4 W/m	1792 lm/m	124 lm/W

Which measure do you need? Contact us!  
Di che misura hai bisogno? Contattaci!

5 m IP65 reel includes:  
2 pcs TST6712S nd 2 pcs TST6712C.



CRI>95

Improve the purchasing experience thanks our LED strip with high Colour Render Index (CRI), to emphasise the shades of every colour and to better show the beauty of the products, that will be perceived exactly as they have been designed.

Migliora l'esperienza di acquisto grazie alle nostre strip LED con alto indice di resa cromatica (CRI), per mettere in risalto le sfumature di ogni colore e mostrare al meglio la bellezza dei prodotti, perché si percepiscano esattamente come sono stati progettati.



CONTROLLERS / CONTROLLER

POWER SUPPLIES / ALIMENTATORI



IP20



IP65

PRD STRAK H ST19H2 / ST19H6

Up to  
151 lm/W

19,2 W/m SMD2835 240 LEDs/m 33,33 mm 3 SDCM



High CRI single-colour LED strip / Strip LED monocore alto CRI

24Vdc 2700K 3000K 4000K CRI>95 5 YEARS OF WARRANTY

Cut to size  
Taglio su misura



IP20

IP65

• IP20 ACCESSORIES

STRIP-TO-STRIP CONNECTION

ATTSTC10  
17x11,7x4,5 mm.

STRIP-TO-POWER SUPPLY CONNECTION

ATFSTC10  
17x11,7x4,5 mm.  
Cable: 100 mm.

STRIP-TO-STRIP CONNECTION WITH CABLE

ATTSTC10  
17x11,7x4,5 mm.  
Cable: 100 mm.

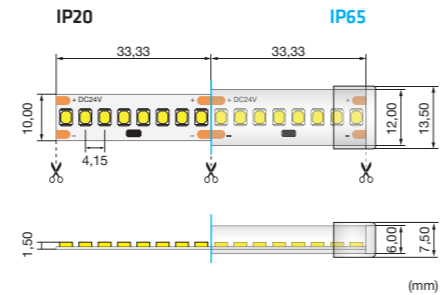

• IP65 ACCESSORIES

END CAP

TST6712S  
(1 piece)

END CAP WITH HOLE

TST6712C  
(1 piece)

	5 m	50 m		CCT				
ST19H22VL0	ST19H22VL5	ST19H22VLM	● 2700K	IP20	19,2 W/m	2770 lm/m	144 lm/W	
ST19H23VL0	ST19H23VL5	ST19H23VLM	● 3000K	IP20	19,2 W/m	2800 lm/m	146 lm/W	
ST19H24VL0	ST19H24VL5	ST19H24VLM	● 4000K	IP20	19,2W/m	2893 lm/m	151 lm/W	
ST19H62VL0	ST19H62VL5	ST19H62VLM	● 2700K	IP65	19,2 W/m	2626 lm/m	137 lm/W	
ST19H63VL0	ST19H63VL5	ST19H63VLM	● 3000K	IP65	19,2 W/m	2663 lm/m	139 lm/W	
ST19H64VL0	ST19H64VL5	ST19H64VLM	● 4000K	IP65	19,2 W/m	2748 lm/m	143 lm/W	

Which measure do you need? Contact us!  
Di che misura hai bisogno? Contattaci!

5 m IP65 reel includes:  
2 pcs TST6712S and 2 pcs TST6712C.

## STRAK T ST96T2

Up to  
109 lm/W

- 9,6 W/m
- SMD2216
- 192 LEDs/m
- 41,67 mm
- 3 SDCM



Special single-colour narrow LED strip / Strip LED monocolor speciale stretta

- 24Vdc
- 2700K
- 3000K
- 4000K
- 6000K
- CRI > 90
- 5 YEARS OF WARRANTY

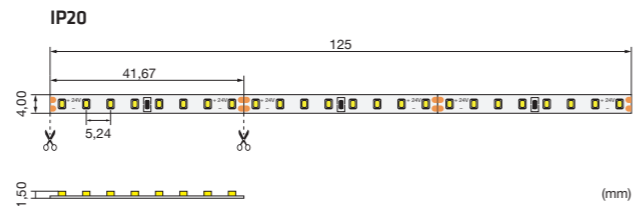

### RECOMENDED PROFILES

#### SURFACE / SUPERFICIE



#### RECESSED / DA INCASSO



#### CORNERS / ANGOLARE



5 m	✂	CCT	💧	⚡	☀	💡
ST96T22VLO	ST96T22VLM	2700K	IP20	9,6 W/m	960 lm/m	100 lm/W
ST96T23VLO	ST96T23VLM	3000K	IP20	9,6 W/m	1000 lm/m	104 lm/W
ST96T24VLO	ST96T24VLM	4000K	IP20	9,6 W/m	1050 lm/m	109 lm/W
ST96T26VLO	ST96T26VLM	6000K	IP20	9,6 W/m	1050 lm/m	109 lm/W

Which measure do you need? Contact us!  
Di che misura hai bisogno? Contattaci!

## STRAK L ST12L2 / ST12L6

Up to  
100 lm/W

- 12 W/m
- SMD3014
- 120 LEDs/m
- 50 mm
- 3 SDCM



Special single-colour side-emitting LED strip / Strip LED monocolor speciale laterale

- 24Vdc
- 2700K
- 4000K
- 6000K
- CRI > 80

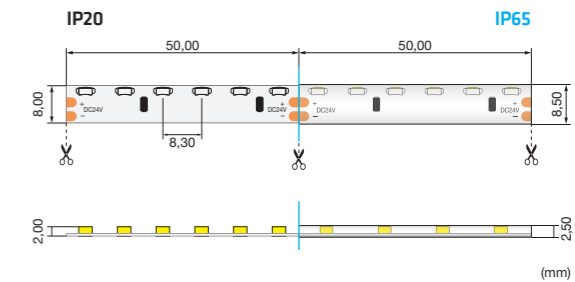

### RECOMENDED PROFILE

#### SURFACE / SUPERFICIE



5 m	✂	CCT	💧	⚡	☀	💡
ST12L22VLO	ST12L22VLO	2700K	IP20	12 W/m	1105 lm/m	92 lm/W
ST12L24VLO	ST12L24VLO	4000K	IP20	12 W/m	1140 lm/m	95 lm/W
ST12L26VLO	ST12L26VLO	6000K	IP20	12 W/m	1200 lm/m	100 lm/W
ST12L62VLO	ST12L62VLO	2700K	IP65	12 W/m	1105 lm/m	92 lm/W
ST12L64VLO	ST12L64VLO	4000K	IP65	12 W/m	1140 lm/m	95 lm/W
ST12L66VLO	ST12L66VLO	6000K	IP65	12 W/m	1200 lm/m	100 lm/W

Which measure do you need? Contact us!  
Di che misura hai bisogno? Contattaci!

PRO STRAK S ST96S2

Up to  
104 lm/W

- 9,6 W/m
- SMD2835
- 120 LEDs/m
- 50 mm
- 3 SDCM



Special single-colour S-shaped LED strip / Strip LED monocolor speciale forma S

- 24Vdc
- 3000K
- 4000K
- 6000K
- CRI >80

Cut to size  
Taglio su misura

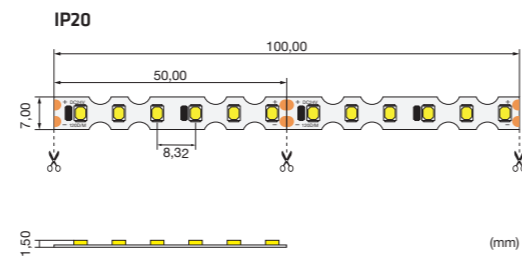

5 m	CCT	IP	W/m	lm/m	lm/W
ST96S23VLO	3000K	IP20	9,6 W/m	990 lm/m	103 lm/W
ST96S24VLO	4000K	IP20	9,6 W/m	1000 lm/m	104 lm/W
ST96S26VLO	6000K	IP20	9,6 W/m	1000 lm/m	104 lm/W

Which measure do you need? Contact us!  
Di che misura hai bisogno? Contattaci!

STRAK L

Lateral LED strip placed behind the mirror, to emit light towards the sink in an elegant way.

Strip LED laterale collocata nella parte posteriore dello specchio per emettere luce verso il lavandino in modo elegante.

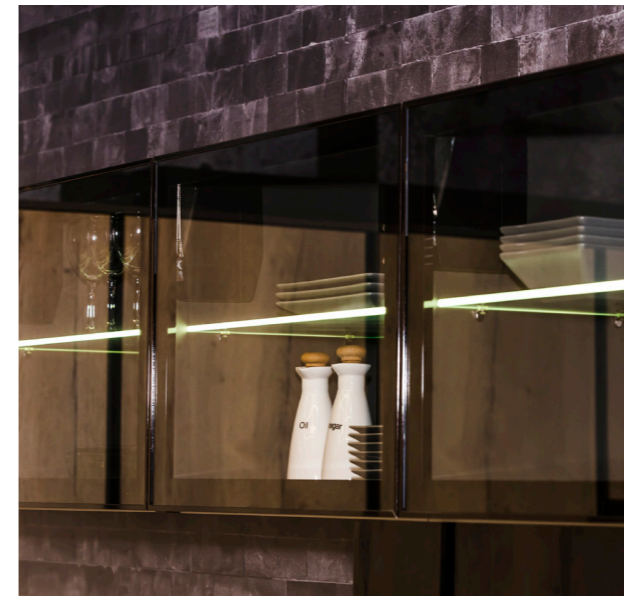

STRAK T

The special narrow LED strip adds a thin line of light that perfectly decorates small spaces, like this display cabinet, and places where the details are important.

La strip LED speciale stretta aggiunge una sottile linea di luce che decora perfettamente spazi ridotti, come questa vetrina, e luoghi dove è importante mettere in risalto i dettagli.

STRAK S

Light up every type of signboard placing our S-shape LED strip in the backside and modelling the light in the desired shape.

Illumina qualsiasi tipo di insegna collocando la nostra strip LED a forma di S nella parte posteriore, modellando la luce nella forma di cui hai bisogno.



PRD STRAK C ST05C2 / ST05C6

Up to 110 lm/W

- 5 W/m
- COB
- 480 LEDs/m
- 50 mm
- 3 SDCM



Single-colour COB LED strip / Strip LED COB monocolor

- 24Vdc
- 2700K
- 3000K
- 4000K
- CRI>90
- 5 YEARS OF WARRANTY



• IP20 ACCESSORIES

STRIP-TO-STRIP CONNECTION

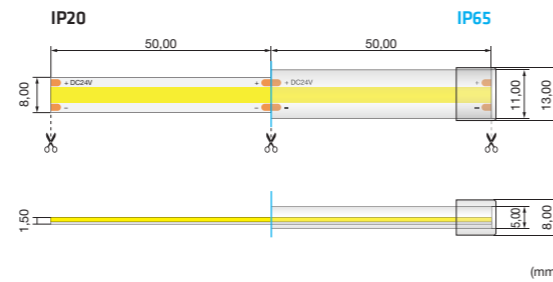
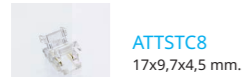

STRIP-TO-POWER SUPPLY CONNECTION

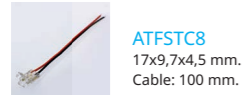

STRIP-TO-STRIP CONNECTION WITH CABLE



• IP65 ACCESSORIES

END CAP



5 m	Scissors	CCT	Water	Lightning	Flame	Lightbulb
ST05C22VL0	ST05C22VLM	● 2700K	IP20	5 W/m	500 lm/m	100 lm/W
ST05C23VL0	ST05C23VLM	● 3000K	IP20	5 W/m	525 lm/m	105 lm/W
ST05C24VL0	ST05C24VLM	● 4000K	IP20	5 W/m	550 lm/m	110 lm/W
ST05C62VL0	ST05C62VLM	● 2700K	IP65	5 W/m	475 lm/m	95 lm/W
ST05C63VL0	ST05C63VLM	● 3000K	IP65	5 W/m	500 lm/m	100 lm/W
ST05C64VL0	ST05C64VLM	● 4000K	IP65	5 W/m	525 lm/m	105 lm/W

5 m IP65 reel includes:  
2 pcs TNFSS and 2 pcs TNFSC.

Which measure do you need? Contact us!  
Di che misura hai bisogno? Contattaci!

PRD STRAK C ST10C2 / ST10C6

Up to 115 lm/W

- 10 W/m
- COB
- 480 LEDs/m
- 50 mm
- 3 SDCM



Single-colour COB LED strip / Strip LED COB monocolor

- 24Vdc
- 2700K
- 3000K
- 4000K
- CRI>90
- 5 YEARS OF WARRANTY



• IP20 ACCESSORIES

STRIP-TO-STRIP CONNECTION

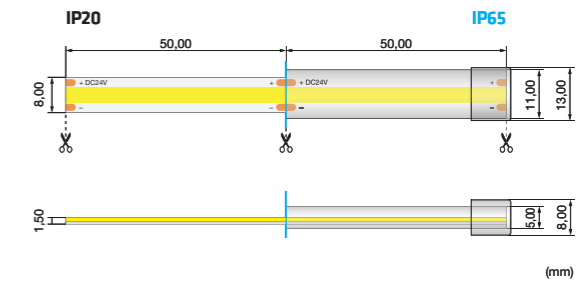
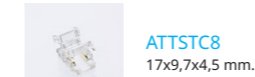

STRIP-TO-POWER SUPPLY CONNECTION



STRIP-TO-STRIP CONNECTION WITH CABLE

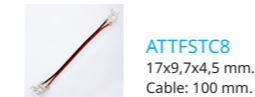

• IP65 ACCESSORIES

END CAP

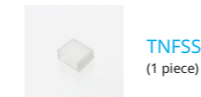

5 m	Scissors	CCT	Water	Lightning	Flame	Lightbulb
ST10C22VL0	ST10C22VLM	● 2700K	IP20	10 W/m	950 lm/m	95 lm/W
ST10C23VL0	ST10C23VLM	● 3000K	IP20	10 W/m	1000 lm/m	100 lm/W
ST10C24VL0	ST10C24VLM	● 4000K	IP20	10 W/m	1147 lm/m	115 lm/W
ST10C62VL0	ST10C62VLM	● 2700K	IP65	10 W/m	918 lm/m	92 lm/W
ST10C63VL0	ST10C63VLM	● 3000K	IP65	10 W/m	950 lm/m	95 lm/W
ST10C64VL0	ST10C64VLM	● 4000K	IP65	10 W/m	1090 lm/m	109 lm/W

5 m IP65 reel includes:  
2 pcs TNFSS and 2 pcs TNFSC.

Which measure do you need? Contact us!  
Di che misura hai bisogno? Contattaci!



PRO STRAK C ST18C2

Up to  
95 lm/W

- 18 W/m
- COB
- 546 LEDs/m
- 38,46 mm
- 3 SDCM



Single-colour COB LED strip / Strip LED COB monocolore

- 24Vdc
- 2700K
- 3000K
- 4000K
- CRI>90
- 5 YEARS OF WARRANTY



• IP20 ACCESSORIES

STRIP-TO-STRIP CONNECTION



ATTSTC10  
17x11,7x4,5 mm.

STRIP-TO-POWER SUPPLY CONNECTION



ATFSTC10  
17x11,7x4,5 mm.  
Cable: 100 mm.

STRIP-TO-STRIP CONNECTION WITH CABLE



ATTFSTC10  
17x11,7x4,5 mm.  
Cable: 100 mm.

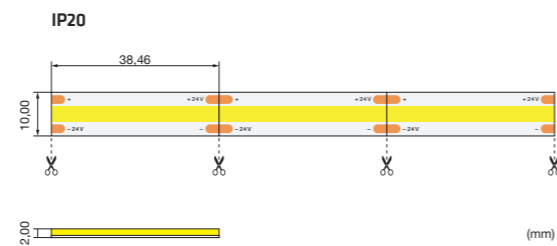

5 m	Scissors icon	CCT	Water drop icon	Lightning bolt icon	Light icon	Lightbulb icon
ST18C22VLO	ST18C22VLM	2700K	IP20	18 W/m	1483 lm/m	82 lm/W
ST18C23VLO	ST18C23VLM	3000K	IP20	18 W/m	1577 lm/m	88 lm/W
ST18C24VLO	ST18C24VLM	4000K	IP20	18 W/m	1713 lm/m	95 lm/W

Which measure do you need? Contact us!  
Di che misura hai bisogno? Contattaci!

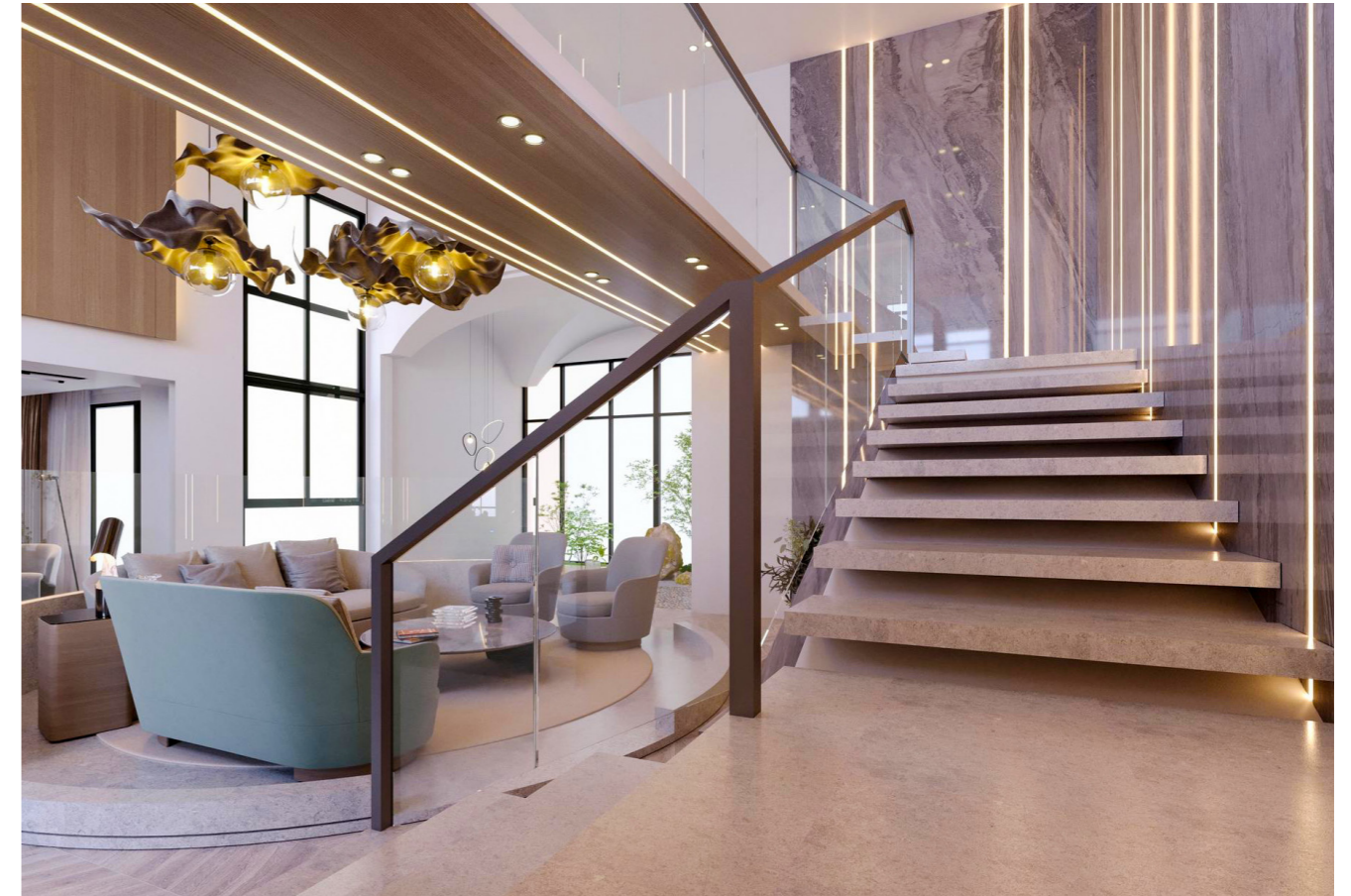

The COB LED strips provide a uniform lighting, ideal for spaces that need an elegant illumination.

Le strip LED COB offrono una luce uniforme, ideale per ambienti che hanno bisogno di un'illuminazione elegante.



# STRAK C ST13C2R

- 13 W/m
- COB
- 672 LEDs/m
- 31,25 mm
- 3 SDCM



RGB COB LED strip / Strip LED COB RGB

- 24Vdc
- RGB
- CRI>90
- 5 YEARS OF WARRANTY

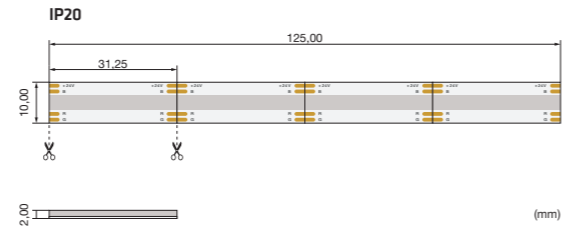

### • IP20 ACCESSORIES

#### STRIP-TO-STRIP CONNECTION



ATTSTCR10  
17x11,7x4,5 mm.

#### STRIP-TO-POWER SUPPLY CONNECTION



ATFSTCR10  
17x11,7x4,5 mm.  
Cable: 100 mm.

#### STRIP-TO-STRIP CONNECTION WITH CABLE



ATTFSTCR10  
17x11,7x4,5 mm.  
Cable: 100 mm.

- 5 m
- CCT
- RGB
- IP20
- 13 W/m

Which measure do you need? Contact us!  
Di che misura hai bisogno? Contattaci!



RGB

With the COB RGB LED strips you can customise every space in all occasions, adding a touch of style and elegance thanks to a professional and uniform lighting.

Con le strip LED COB RGB potrai personalizzare qualsiasi ambiente in ogni occasione, aggiungendo un tocco di eleganza e di stile grazie a un'illuminazione professionale e uniforme.

PRO STRAK HB ST96H2B / ST96H6B

Up to 81 lm/W

- 9,6 W/m
- SMD3527
- 60 LEDs/m
- 100 mm
- 3 SDCM



Two-colour LED strip / Strip LED bicolore

- 24Vdc
- 2700K - 6000K
- CRI >80

Cut to size  
Taglio su misura

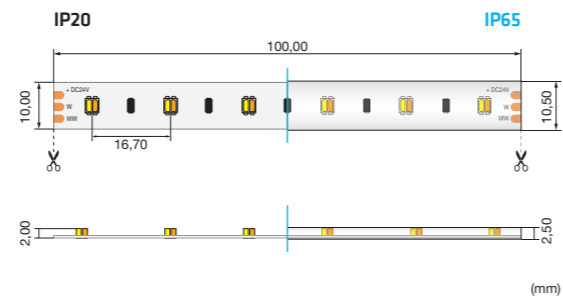

5 m	CCT	IP	W/m	lm/m	lm/W
ST96H2BVLO	2700K - 6000K	IP20	9,6 W/m	670 ~ 780 lm/m	70 ~ 81 lm/W
ST96H2BVLM	2700K - 6000K	IP20	9,6 W/m	670 ~ 780 lm/m	70 ~ 81 lm/W
ST96H6BVLO	2700K - 6000K	IP65	9,6 W/m	670 ~ 780 lm/m	70 ~ 81 lm/W
ST96H6BVLM	2700K - 6000K	IP65	9,6 W/m	670 ~ 780 lm/m	70 ~ 81 lm/W

Which measure do you need? Contact us!  
Di che misura hai bisogno? Contattaci!

PRO STRAK HB ST10H2B / ST10H6B

Up to 75 lm/W

- 9,6 W/m
- SMD3528
- 120 LEDs/m
- 100 mm
- 3 SDCM



Two-colour LED strip / Strip LED bicolore

- 24Vdc
- 2700K - 6000K
- CRI >80

Cut to size  
Taglio su misura

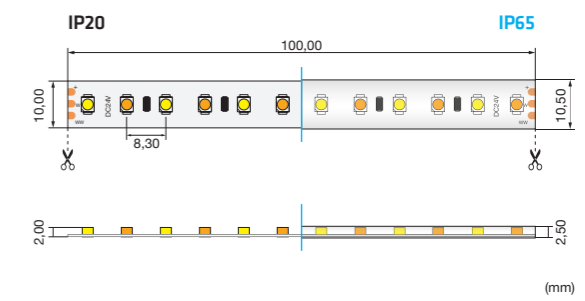

5 m	CCT	IP	W/m	lm/m	lm/W
ST10H2BVLO	2700K - 6000K	IP20	9,6 W/m	600 ~ 720 lm/m	63 ~ 75 lm/W
ST10H2BVLM	2700K - 6000K	IP20	9,6 W/m	600 ~ 720 lm/m	63 ~ 75 lm/W
ST10H6BVLO	2700K - 6000K	IP65	9,6 W/m	600 ~ 720 lm/m	63 ~ 75 lm/W
ST10H6BVLM	2700K - 6000K	IP65	9,6 W/m	600 ~ 720 lm/m	63 ~ 75 lm/W

Which measure do you need? Contact us!  
Di che misura hai bisogno? Contattaci!

IP20

IP65

IP20

IP65

# STRAK HB ST19H2B / ST19H6B

Up to  
128 lm/W

- 19,2 W/m
- SMD2835
- 112 LEDs/m
- 125 mm
- 3 SDCM

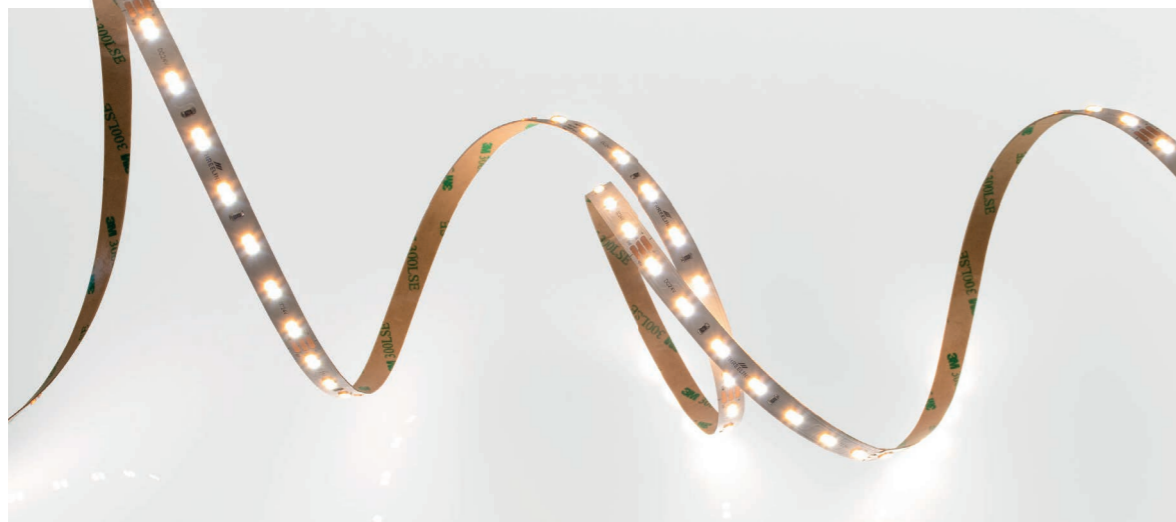

Two-colour LED strip / Strip LED bicolore

2700K - 6000K

Cut to size  
 Taglio su misura

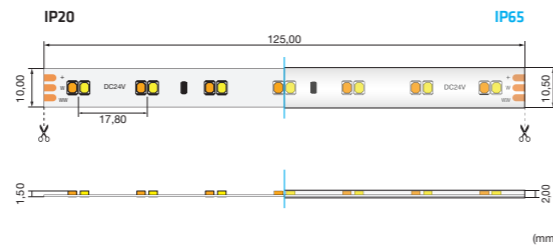

5 m	Scissors icon	CCT	Water icon	Lightning bolt icon	Light icon	Light icon
ST19H2BVL0	ST19H2BVL M	2700K ~ 6000K	IP20	19,2 W/m	2119 ~ 2458 lm/m	110 ~ 128 lm/W
ST19H6BVL0	ST19H6BVL M	2700K ~ 6000K	IP65	19,2 W/m	2119 ~ 2458 lm/m	110 ~ 128 lm/W

Which measure do you need? Contact us!  
Di che misura hai bisogno? Contattaci!



Optimise the lighting with our bicolour LED strips: change from cool white to warm white, according to your needs, to create a more welcoming environment, or regulate the colour temperature for a more efficient lighting. These LED strips blend together functionality and elegance, providing a dynamic and refined solution for every situation.

*Ottimizza l'illuminazione con le nostre strip LED bicolore: cambia da luce fredda a luce calda, a seconda delle tue esigenze, per creare un ambiente più accogliente o regola la temperatura di colore per un'illuminazione più efficiente. Con queste strip LED, funzionalità ed eleganza si fondono, offrendo una soluzione dinamica e raffinata per qualsiasi situazione.*



PRD STRAK WB ST12W2B / ST12W6B

Up to  
120 lm/W

- 12 W/m
- SMD2835
- 168 LEDs/m
- 83,34 mm
- 3 SDCM



Dim-to-Warm LED strip / Strip LED Dim-to-Warm

- 24Vdc
- 3000K ~ 1800K
- CRI > 80
- 5 YEARS OF WARRANTY

Cut to size  
Taglio su misura

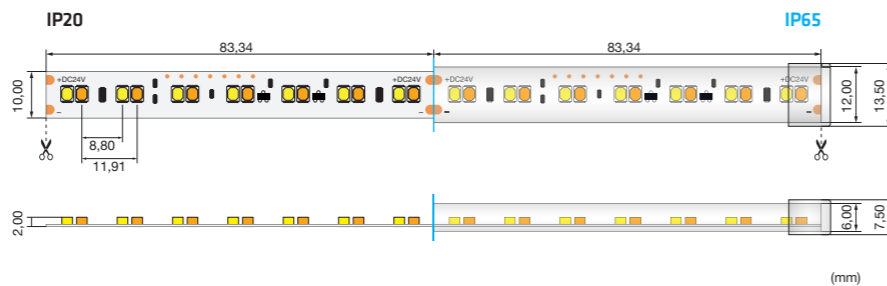

• IP20 ACCESSORIES

STRIP-TO-STRIP CONNECTION



STRIP-TO-POWER SUPPLY CONNECTION

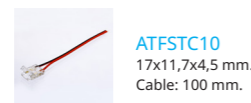

STRIP-TO-STRIP CONNECTION WITH CABLE



• IP65 ACCESSORIES

END CAP



END CAP WITH HOLE



5 m	CCT	3000K ~ 1800K	IP20	12 W/m	1435 ~ 36 lm/m	120 ~ 3 lm/W
ST12W2BVLO	ST12W2BVLM	3000K ~ 1800K	IP20	12 W/m	1435 ~ 36 lm/m	120 ~ 3 lm/W
ST12W6BVLO	ST12W6BVLM	3000K ~ 1800K	IP65	12 W/m	1357 ~ 34 lm/m	113 ~ 3 lm/W

5 m IP65 reel includes:  
2 pcs TST6712S and 2 pcs TST6712C.

Which measure do you need? Contact us!  
Di che misura hai bisogno? Contattaci!



Experience the versatility of our Dim-to-Warm LED strips that gradually adapt the colour temperature while light intensity is regulated, simulating the dimming curve of traditional incandescent lamps. This LED strip makes possible subtle variations in the warm white light, in order to create the perfect atmosphere for moments in which light is the protagonist. Discover the ideal balance between practicality and comfort.

*Sperimenta la versatilità della nostra strip LED Dim-to-Warm, che adatta la temperatura di colore man mano che si regola l'intensità di luce, simulando la curva di regolazione delle lampade incandescenti tradizionali. Questa strip LED rende possibili lievi variazioni nella luce bianca calda, creando così l'atmosfera ideale per momenti in cui la luce è protagonista. Scopri l'equilibrio perfetto tra praticità e comfort.*

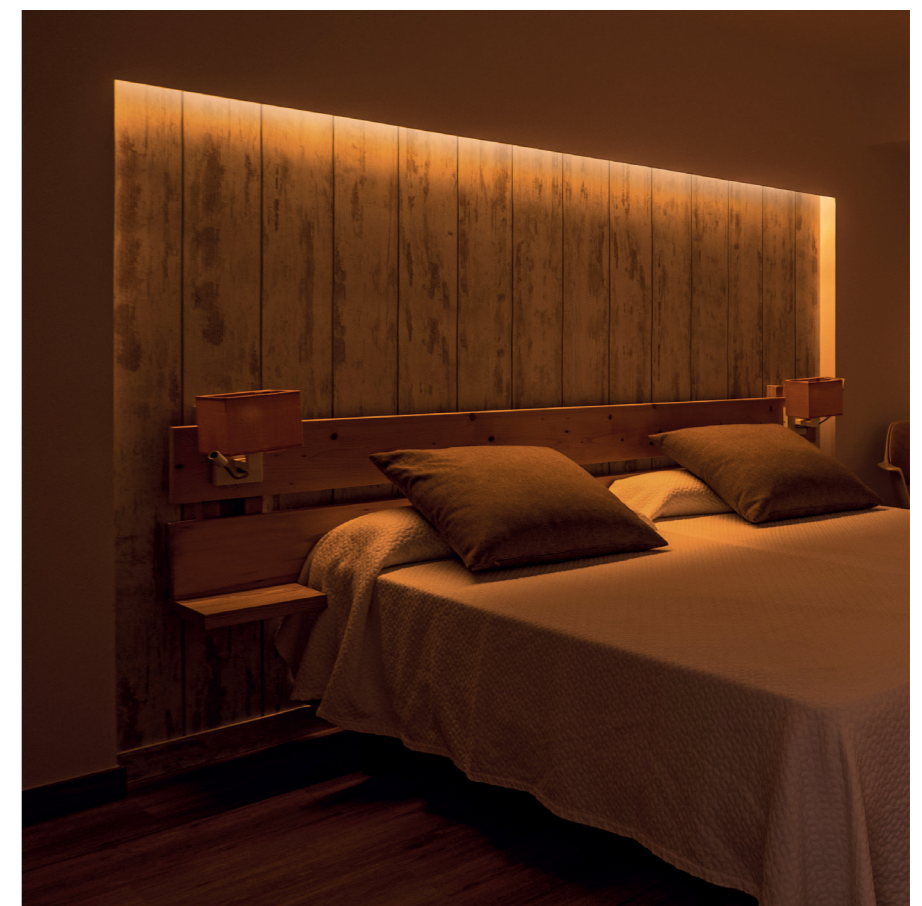

## STRAK XR ST14X2R / ST14X6R

14,4 W/m 5050RGB 60 LEDs/m 100 mm 3 SDCM

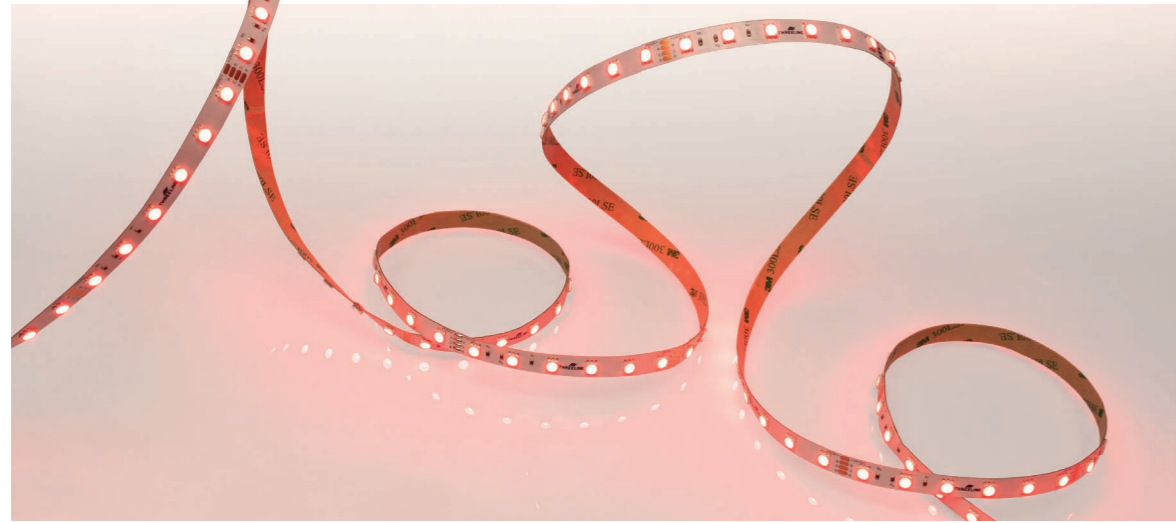

RGB LED strip / Strip LED RGB



### • IP20 ACCESSORIES

#### STRIP-TO-STRIP CONNECTION



**ATTSTXR10**  
17x11,7x4,5 mm.

#### STRIP-TO-POWER SUPPLY CONNECTION



**ATFSTXR10**  
17x11,7x4,5 mm.  
Cable: 100 mm.

#### STRIP-TO-STRIP CONNECTION WITH CABLE



**ATTFSTXR10**  
17x11,7x4,5 mm.  
Cable: 100 mm.

### • IP65 ACCESSORIES

#### END CAP



**TST6712S**  
(1 piece)

#### END CAP WITH HOLE



**TST6712C**  
(1 piece)

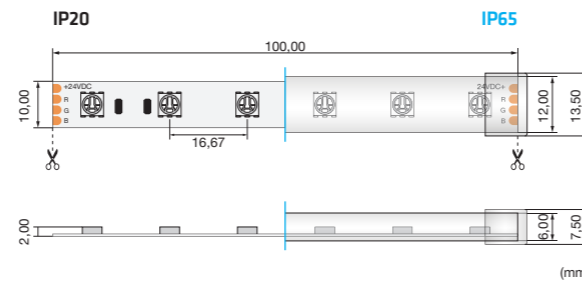

5 m	50 m	CCT	RGB	IP20	14,4 W/m
ST14X2RVL0	ST14X2RVL5	ST14X2RVL M	RGB	IP20	14,4 W/m
ST14X6RVL0	ST14X6RVL5	ST14X6RVL M	RGB	IP65	14,4 W/m

Which measure do you need? Contact us!  
Di che misura hai bisogno? Contattaci!

## STRAK HR ST14H2R

14,4 W/m 2835RGB 120 LEDs/m 50 mm 3 SDCM

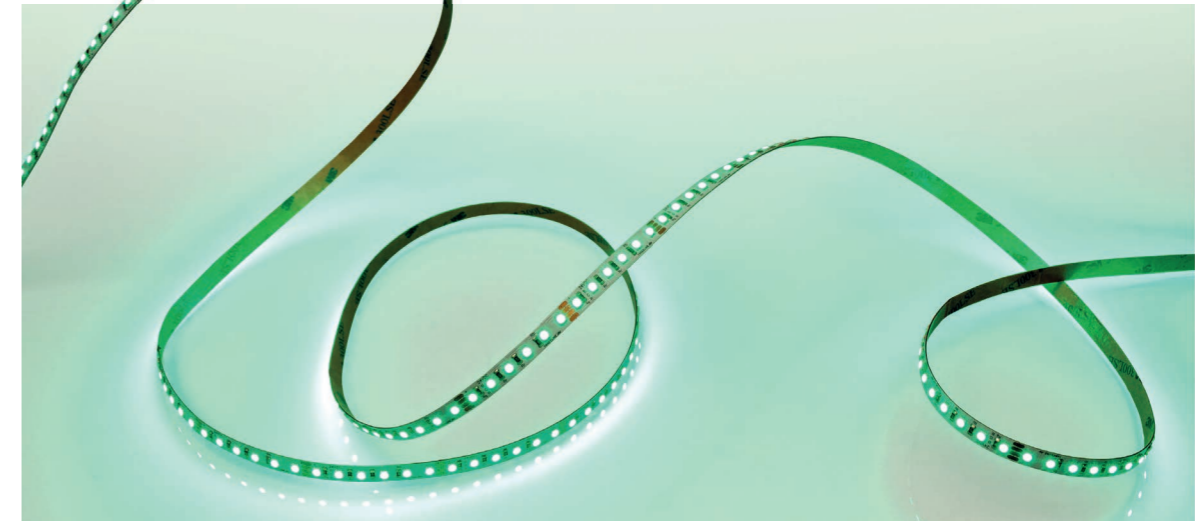

High density RGB LED strip / Strip LED RGB alta densità



### • IP20 ACCESSORIES

#### STRIP-TO-STRIP CONNECTION



**ATTSTHR8**  
17x9,7x4,5 mm.

#### STRIP-TO-POWER SUPPLY CONNECTION



**ATFSTHR8**  
17x9,7x4,5 mm.  
Cable: 100 mm.

#### STRIP-TO-STRIP CONNECTION WITH CABLE



**ATTFSTHR8**  
17x9,7x4,5 mm.  
Cable: 100 mm.

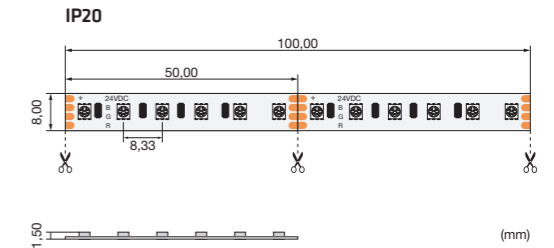

5 m	50 m	CCT	RGB	IP20	14,4 W/m
ST14H2RVL0	ST14H2RVL5	ST14H2RVL M	RGB	IP20	14,4 W/m

Which measure do you need? Contact us!  
Di che misura hai bisogno? Contattaci!

# STRAK R3 ST14R23 / ST14R63

Up to 104 lm/W

- 14,4 W/m
- 5050RGB SMD2835
- 120 LEDs/m
- 100 mm
- 3 SDCM



RGB + WW (Warm White) LED strip / Strip LED RGB + WW (Warm White)

- 24Vdc
- RGB
- 3000K
- CRI >80
- 5 YEARS OF WARRANTY



## • IP20 ACCESSORIES

### STRIP-TO-STRIP CONNECTION

- ATTSTR+W10**  
17x11,7x4,5 mm.

### STRIP-TO-POWER SUPPLY CONNECTION

- ATFSTR+W10**  
17x11,7x4,5 mm.  
Cable: 100 mm.

### STRIP-TO-STRIP CONNECTION WITH CABLE

- ATTFSTR+W10**  
17x11,7x4,5 mm.  
Cable: 100 mm.

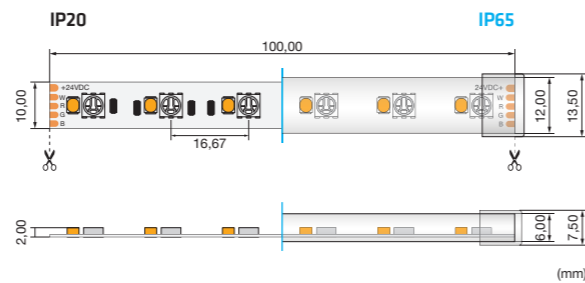

## • IP65 ACCESSORIES

### END CAP

- TST6712S**  
(1 piece)

5 m	50 m	CCT	IP	W/m	lm/m	lm/W
ST14R23VLO	ST14R23VL5	ST14R23VLM	RGB + 3000K	IP20	14,4 W/m	
ST14R63VLO	ST14R63VL5	ST14R63VLM	RGB + 3000K	IP65	14,4 W/m	

### END CAP WITH HOLE

- TST6712C**  
(1 piece)

CCT	IP	W/m	lm/m	lm/W
3000K	IP20	7,2 W/m	747 lm/m	104 lm/W
3000K	IP65	7,2 W/m	712 lm/m	99 lm/W

5 m IP65 reel includes:  
2 pcs TST6712S and 2 pcs TST6712C.



This models of RGB LED strip offer a multifunctional lighting system, that combines a wide range of colour. Moreover, the RGB+WW LED strip is provided with the warm white to create welcoming environments when the situation requires it.

Questi modelli di strip LED RGB offrono un sistema di illuminazione multifunzionale, che combina un'ampia gamma di colori. Inoltre, il modello RGB+WW è dotato del bianco caldo per creare ambienti accoglienti quando la situazione lo richiede.

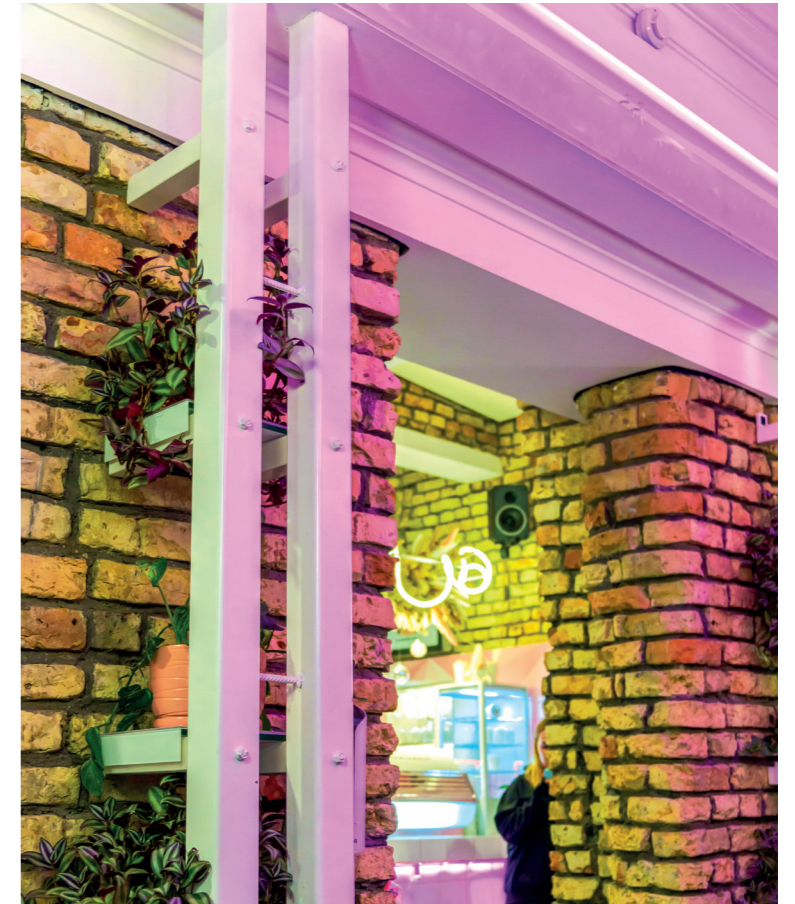

# STRAK RB ST17R2B / ST17R6B

Up to 115 lm/W

- 16,8 W/m
- 5050RGB SMD2835
- 180 LEDs/m
- 100 mm
- 3 SDCM



RGB + TW (Tunable White) LED strip / Strip LED RGB + TW (Tunable White)

- 24Vdc
- RGB
- 1800K ~ 6000K
- CRI >80
- 5 YEARS OF WARRANTY



### • IP20 ACCESSORIES

#### STRIP-TO-STRIP CONNECTION

**ATTSTWB12**  
13,5x13,8x4,2 mm.

#### STRIP-TO-POWER SUPPLY CONNECTION

**ATFSTWB12**  
13,5x13,8x4,2 mm.  
Cable: 150 mm.

#### STRIP-TO-STRIP CONNECTION WITH CABLE

**ATTFSTWB12**  
13,5x13,8x4,2 mm.  
Cable: 150 mm.

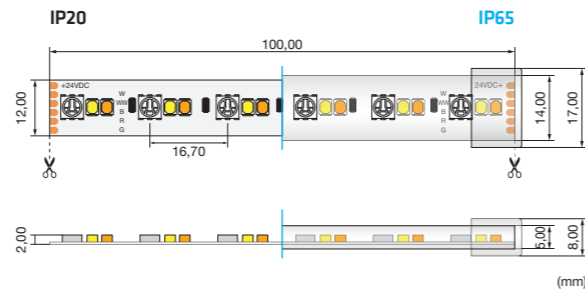

### • IP65 ACCESSORIES

#### END CAP

**TST6714S**  
(1 piece)

#### END CAP WITH HOLE

**TST6714C**  
(1 piece)

5 m	50 m	CCT	IP	W/m
ST17R2BVLO	ST17R2BVL5	ST17R2BVL M	RGB + 1800K ~ 6000K	IP20 16,8 W/m
ST17R6BVLO	ST17R6BVL5	ST17R6BVL M	RGB + 1800K ~ 6000K	IP65 16,8 W/m

CCT	IP	W/m	lm/m	lm/W
1800K ~ 6000K	IP20	4,8 + 4,8 W/m	342 ~ 550 lm/m	72 ~ 115 lm/W
1800K ~ 6000K	IP65	4,8 + 4,8 W/m	325 ~ 523 lm/m	68 ~ 109 lm/W

5 m IP65 reel includes:  
2 pcs TST6714S and 2 pcs TST6714C.



RGB + 1800K ~ 6000K

The colour variety of RGB LED strips, combined with the wide spectrum of Tunable White, that goes from a very warm white to cool white, makes this LED strip one of the most complete on the market, as it is shown by its usage in this underground station.

La varietà di colori delle strip LED RGB, combinata con l'ampio spettro di tonalità del Tunable White, che va dal bianco molto caldo al bianco freddo, rende questa strip LED una delle più complete sul mercato, come si può notare dal suo utilizzo in questa stazione metro.

# STRAK DR ST14D6R

- ⚡ 14,4 W/m
- 👁️ 5050RGB
- 📏 60 LEDs/m
- ✂️ 100 mm
- 🌀 3 SDCM

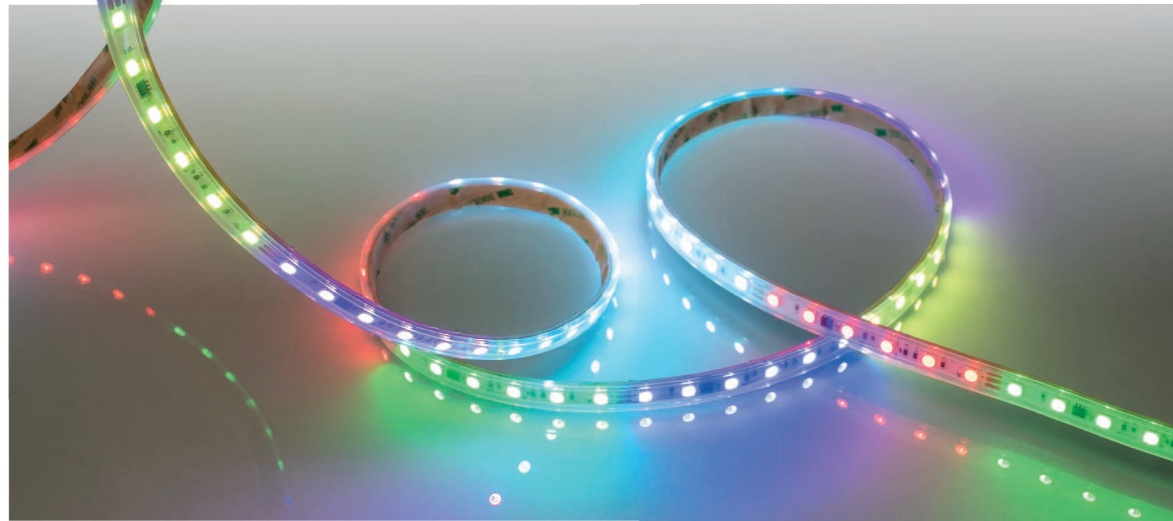

Digital RGB LED strip / Strip LED RGB digitale

- 🔌 24Vdc
- 🌈 RGB
- 📏 CRI >80

Cut to size  
Taglio su misura

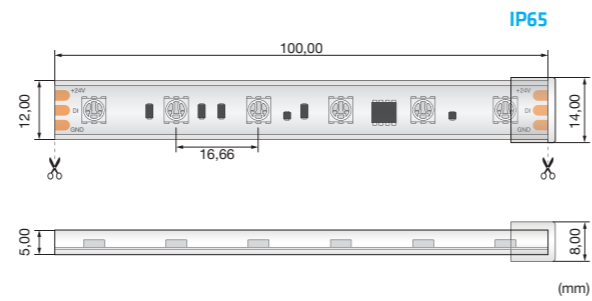

- 🌀 5 m
- ✂️ CCT
- 🌈 RGB
- 💧 IP65
- ⚡ 14,4 W/m

Which measure do you need? Contact us!  
Di che misura hai bisogno? Contattaci!

# STRAK D6 ST19D66

- ⚡ 19,2 W/m
- 👁️ 5050RGB
- 📏 60 LEDs/m
- ✂️ 100 mm
- 🌀 3 SDCM



Digital RGB + W LED strip / Strip LED RGB+W digitale

- 🔌 24Vdc
- 🌈 RGB
- ⊕ 6000K
- 📏 CRI >80

Cut to size  
Taglio su misura

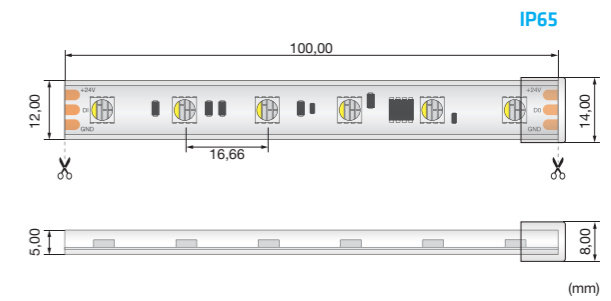















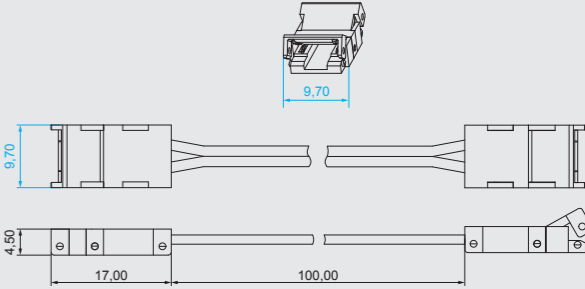





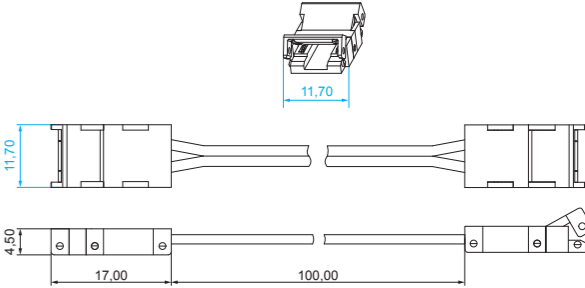

- 🌀 5 m
- ✂️ CCT
- 🌈 RGB + 🟦 6000K
- 💧 IP65
- ⚡ 19,2 W/m
- 📏 751 lm/m
- 💡 39 lm/W

Which measure do you need? Contact us!  
Di che misura hai bisogno? Contattaci!

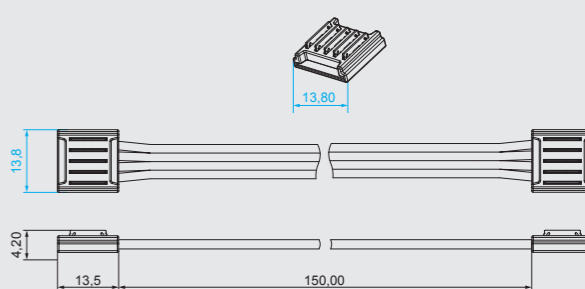

# IP20 LED STRIP ACCESSORIES / ACCESSORI STRIP LED IP20

	STRIP-TO-STRIP CONNECTION CONNESSIONE STRIP-STRIP	STRIP-TO-POWER SUPPLY CONNECTION CONNESSIONE STRIP-ALIMENTATORE	STRIP-TO-STRIP CONNECTION WITH CABLE CONNESSIONE STRIP-STRIP CON CAVO	ACCESSORIES PLANE PIANO ACCESSORI
STRIPS / STRIP 8 mm	<p><b>ATTSTC8</b></p>  <p>2 poles / 2 pin 17x9,7x4,5 mm.</p> <p><b>ATTSTHR8</b></p>  <p>4 poles / 4 pin 17x9,7x4,5 mm.</p>	<p><b>ATFSTC8</b></p>  <p>2 poles / 2 pin 17x9,7x4,5 mm.</p> <p><b>ATFSTHR8</b></p>  <p>4 poles / 4 pin 17x9,7x4,5 mm.</p>	<p><b>ATTFSTC8</b></p>  <p>2 poles / 2 pin 17x9,7x4,5 mm.</p> <p><b>ATTFSTHR8</b></p>  <p>4 poles / 4 pin 17x9,7x4,5 mm.</p>	
STRIPS / STRIP 10 mm	<p><b>ATTSTC10</b></p>  <p>2 poles / 2 pin 17x11,7x4,5 mm.</p> <p><b>ATTSTXR10</b></p>  <p>4 poles / 4 pin 17x11,7x4,5 mm.</p>	<p><b>ATFSTC10</b></p>  <p>2 poles / 2 pin 17x11,7x4,5 mm.</p> <p><b>ATFSTXR10</b></p>  <p>4 poles / 4 pin 17x11,7x4,5 mm.</p>	<p><b>ATTFSTCR10</b></p>  <p>4 poles / 4 pin 17x11,7x4,5 mm.</p> <p><b>ATTFSTR+W10</b></p>  <p>5 poles / 5 pin 17x11,7x4,5 mm.</p>	
	<p><b>ATTSTCR10</b></p>  <p>4 poles / 4 pin 17x11,7x4,5 mm.</p> <p><b>ATTSTR+W10</b></p>  <p>5 poles / 5 pin 17x11,7x4,5 mm.</p>	<p><b>ATFSTCR10</b></p>  <p>4 poles / 4 pin 17x11,7x4,5 mm.</p> <p><b>ATFSTR+W10</b></p>  <p>5 poles / 5 pin 17x11,7x4,5 mm.</p>	<p><b>ATTFSTC10</b></p>  <p>2 poles / 2 pin 17x11,7x4,5 mm.</p> <p><b>ATTFSTXR10</b></p>  <p>4 poles / 4 pin 17x11,7x4,5 mm.</p>	
STRIPS / STRIP 12 mm	<p><b>ATTSTWB12</b></p>  <p>6 poles / 2 pin 13,5x13,8x4,2 mm.</p>	<p><b>ATFSTWB12</b></p>  <p>6 poles / 2 pin 13,5x13,8x4,2 mm.</p>	<p><b>ATTFSTWB12</b></p>  <p>6 poles / 2 pin 13,5x13,8x4,2 mm.</p>	



The accessories for the 8 mm and 10mm IP20 LED strip are compatible with the standard 12 mm profiles.  
Gli accessori per le strip LED da 8mm e 10 mm IP20 sono compatibili con i profili standard da 12 mm.



**5RGBWC1M**  
1 m cable (5 pins) for RGB+W LED strips.  
Cavo da 1 m (5 pin) per strip LED RGB+W.

# NEON FLEX

## NEON TOP

Reduced size / *Misura ridotta*  
Decorative / *Decorativa*  
Elegant / *Elegante*

## NEON SMOOTH LINE

Innovative / *Innovativa*  
Adaptable / *Versatile*  
High efficiency / *Alta efficienza*

## NEON SIDE

Special applications / *Installazioni speciali*  
Indirect lighting / *Luce indiretta*  
Unique shapes / *Forme uniche*

## NEON 360°

Aesthetics / *Estetica*  
Trend / *Tendenza*  
Flexible / *Flessibile*

DIM TO WARM  
DIM TO WARM

RGB  
RGB

DIGITAL RGB  
RGB DIGITALE

ACCESSORIES  
ACCESSORI

NEON FLEX  
NEON FLEX

## PRO NEON TOP NF72F6

Up to  
92 lm/W

7,2 W/m SMD3014 210 LEDs/m 33,4 mm 3 SDCM



Neon flex Top-View LED strip / *Strip LED neon flex Top-View (Luce frontale)*

24Vdc 2700K 3000K 4000K CRI >80 5 YEARS OF WARRANTY

Cut to size  
Taglio su misura

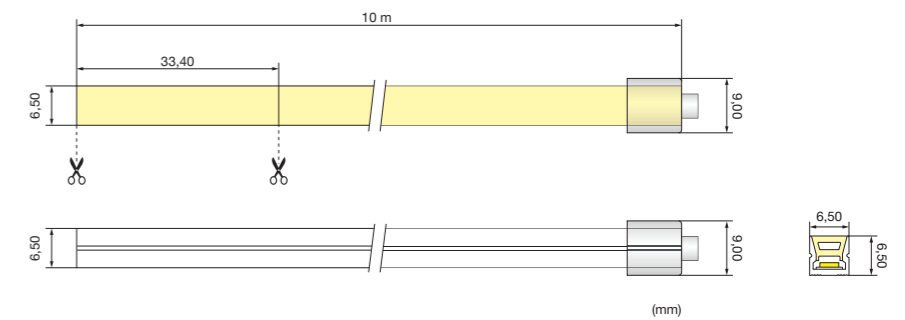

### ACCESSORIES

#### MOUNTING CLIPS



#### END CAP



#### END CAP WITH HOLE



10 m reel includes:  
• 40 pcs ACNFF  
• 4 pcs TNFFS  
• 4 pcs TNFFC

10 m	Scissors	CCT	Water	Lightning	Speaker	Lightbulb
NF72F62VL1	NF72F62VLM	2700K	IP65	7,2 W/m	622 lm/m	86 lm/W
NF72F63VL1	NF72F63VLM	3000K	IP65	7,2 W/m	630 lm/m	87 lm/W
NF72F64VL1	NF72F64VLM	4000K	IP65	7,2 W/m	662 lm/m	92 lm/W

Which measure do you need? **Contact us!**  
*Di che misura hai bisogno? Contattaci!*

PRO NEON SMOOTH LINE NF15S6

Up to 136 lm/W

- 15 W/m
- SMD2835
- 238 LEDs/m
- 29,4 mm
- 3 SDCM



Smooth Line single-colour LED strip / Strip LED Smooth Line monocolor

- 24Vdc
- 2700K
- 3000K
- 4000K
- CRI >80
- 5 YEARS OF WARRANTY

Cut to size  
Taglio su misura

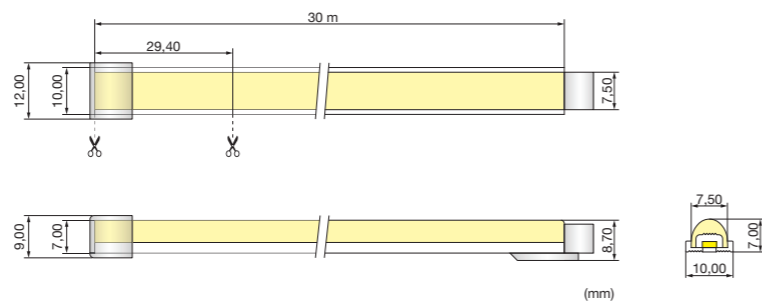

• ACCESSORIES

MOUNTING CLIPS



END CAP



END CAP WITH HOLE



- 30 m reel includes:
- 120 pcs ACNFS
- 4 pcs TNFSS
- 4 pcs TNFSC

30 m	✂	CCT	IP65	⚡	💡	💡
NF15S62VL3	NF15S62VLM	2700K	IP65	15 W/m	1870 lm/m	125 lm/W
NF15S63VL3	NF15S63VLM	3000K	IP65	15 W/m	1875 lm/m	125 lm/W
NF15S64VL3	NF15S64VLM	4000K	IP65	15 W/m	2040 lm/m	136 lm/W

Which measure do you need? Contact us!  
Di che misura hai bisogno? Contattaci!

PRO NEON SMOOTH LINE NF15S6R

- 15 W/m
- SMD2835
- 168 LEDs/m
- 41,67 mm
- 3 SDCM



Smooth Line single-colour RGB LED strip / Strip LED Smooth Line RGB

- 24Vdc
- RGB
- CRI >80
- 5 YEARS OF WARRANTY

Cut to size  
Taglio su misura

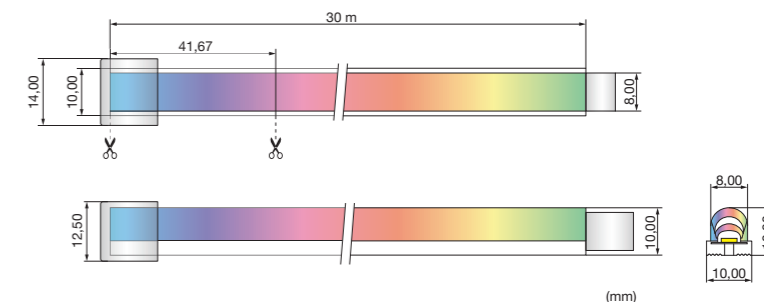

• ACCESSORIES

MOUNTING CLIPS



END CAP



END CAP WITH HOLE



- 30 m reel includes:
- 120 pcs ACNFS
- 4 pcs TNFSRS
- 4 pcs TNFSRC

30 m	✂	CCT	RGB	IP65	⚡
NF15S6RVL3	NF15S6RVLM	RGB	RGB	IP65	15 W/m

Which measure do you need? Contact us!  
Di che misura hai bisogno? Contattaci!

PRO NEON SIDE NF77L6

Up to 55 lm/W

- 7,7 W/m
- SMD2835
- 128 LEDs/m
- 62 mm
- 3 SDCM



Neon flex Side-emitting single-colour LED strip / Strip LED neon flex side-emitting (Luce laterale) monocolora

- 24Vdc
- 2700K
- 3000K
- 4000K
- CRI >80
- 5 YEARS OF WARRANTY

Cut to size  
Taglio su misura

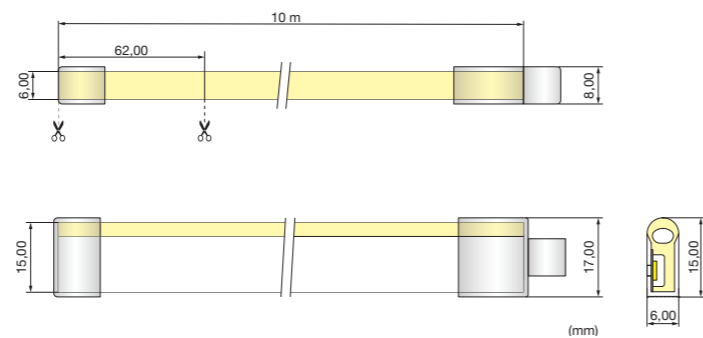

• ACCESSORIES

MOUNTING CLIPS



END CAP

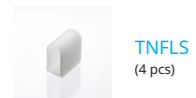

END CAP WITH HOLE



- 10 m reel includes:
- 40 pcs ACNFL
  - 4 pcs TNFLS
  - 4 pcs TNFLC

10 m	✂	CCT	IP	W/m	lm/m	lm/W
NF77L62VL1	NF77L62VLM	2700K	IP65	7,7 W/m	405 lm/m	53 lm/W
NF77L63VL1	NF77L63VLM	3000K	IP65	7,7 W/m	410 lm/m	53 lm/W
NF77L64VL1	NF77L64VLM	4000K	IP65	7,7 W/m	426 lm/m	55 lm/W

Which measure do you need? Contact us!  
Di che misura hai bisogno? Contattaci!

PRO NEON SIDE NF14L6R

- 14,4 W/m
- SMD2835
- 120 LEDs/m
- 50 mm
- 3 SDCM



Neon flex Side-emitting RGB LED strip / Strip LED neon flex side-emitting (Luce laterale) RGB

- 24Vdc
- RGB
- CRI >80
- 5 YEARS OF WARRANTY

Cut to size  
Taglio su misura

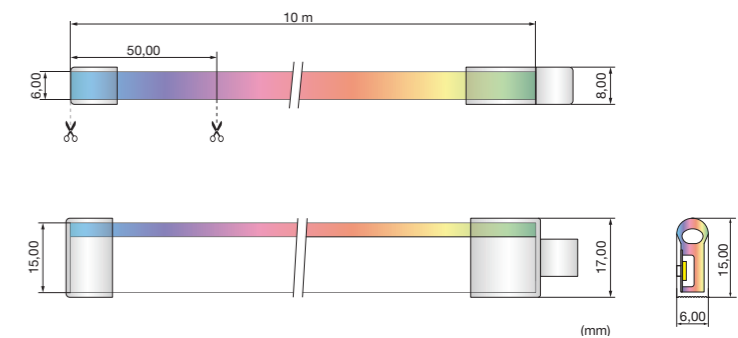

• ACCESSORIES

MOUNTING CLIPS



END CAP



END CAP WITH HOLE



- 10 m reel includes:
- 40 pcs ACNFL
  - 4 pcs TNFLS
  - 4 pcs TNFLC

10 m	✂	CCT	IP	W/m
NF14L6RVL1	NF14L6RVLM	RGB	IP65	14,4 W/m

Which measure do you need? Contact us!  
Di che misura hai bisogno? Contattaci!

PRO NEON 360° NF12C6

Up to  
125 lm/W

- 12 W/m
- SMD2835
- 256 LEDs/m
- 62,5 mm
- 3 SDCM



Neon flex 360° single-colour LED strip / Strip LED neon flex 360° monocolor

- 24Vdc
- 2700K
- 3000K
- 4000K
- CRI >80
- 5 YEARS OF WARRANTY

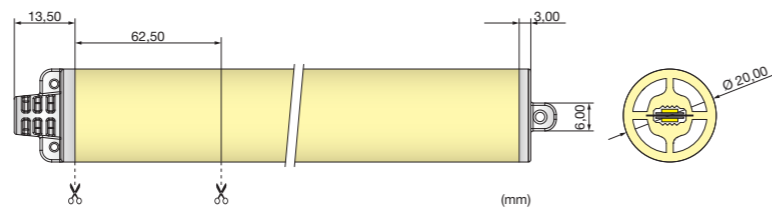

• ACCESSORIES

MOUNTING CLIPS



✂	CCT	💧	⚡	☀	💡
NF12C6236M	2700K	IP65	12 W/m	1430 lm/m	119 lm/W
NF12C6336M	3000K	IP65	12 W/m	1440 lm/m	120 lm/W
NF12C6436M	4000K	IP65	12 W/m	1500 lm/m	125 lm/W

Which measure do you need? Contact us!  
Di che misura hai bisogno? Contattaci!

PRO NEON 360° NF12C6R

- 12 W/m
- SMD2835
- 240 LEDs/m
- 50 mm
- 3 SDCM



Neon flex 360° RGB LED strip / Strip LED neon flex 360° RGB

- 24Vdc
- RGB
- CRI >80
- 5 YEARS OF WARRANTY

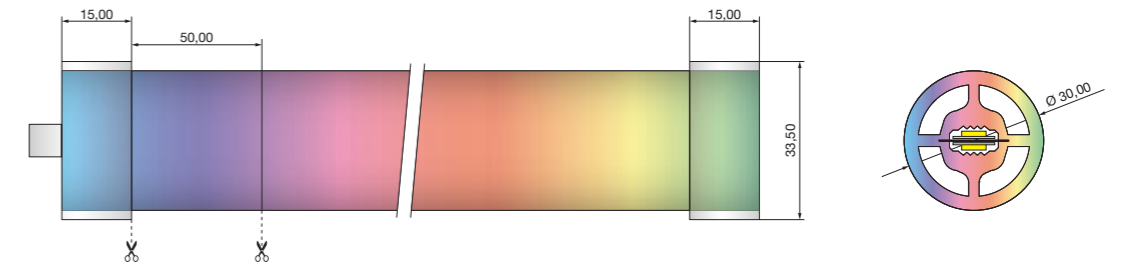

• ACCESORIOS

MOUNTING CLIPS



✂	CCT	💧	⚡
NF12C6R36M	RGB	IP65	12 W/m

Which measure do you need? Contact us!  
Di che misura hai bisogno? Contattaci!

# WIDTH AND HEIGHT OF LED STRIPS / LARGHEZZA E ALTEZZA STRIP LED

IP20 | IP65

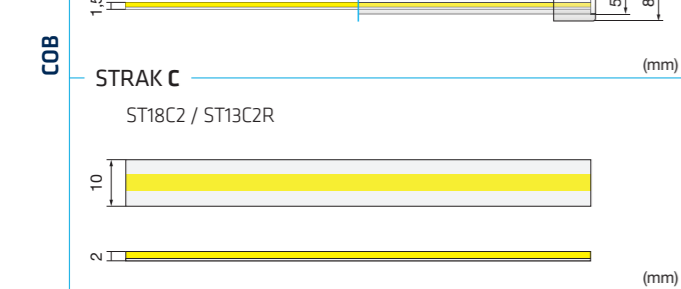
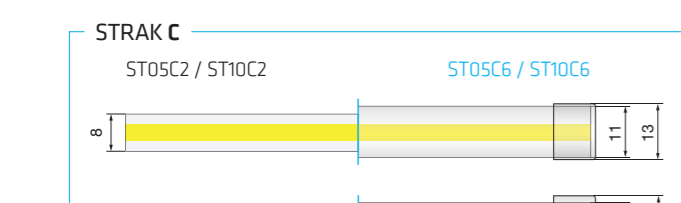
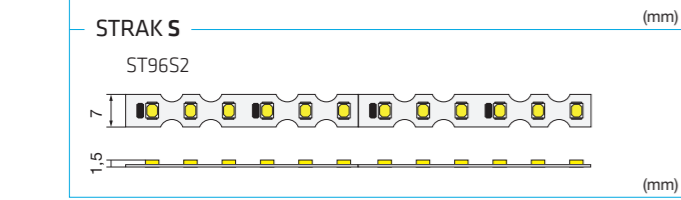
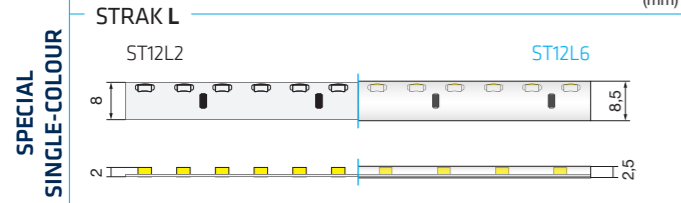
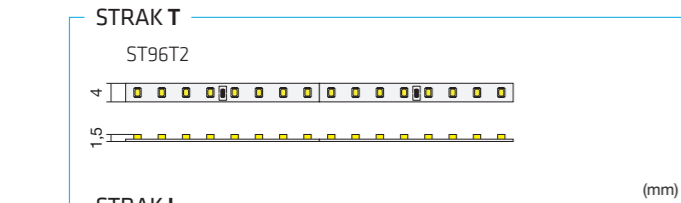
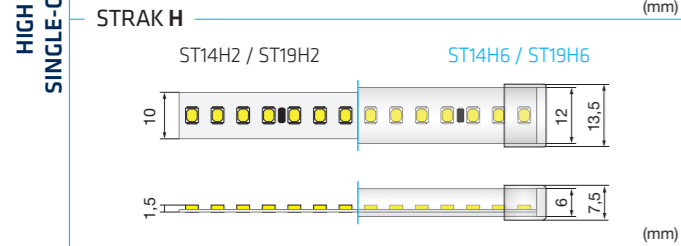
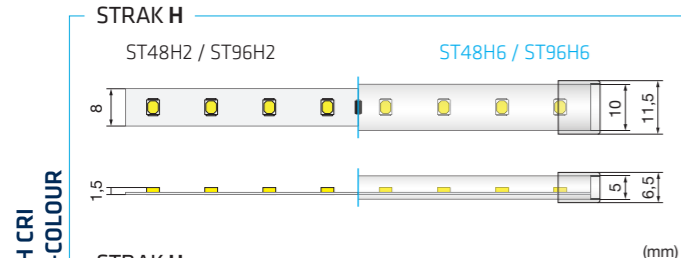

IP20 | IP65

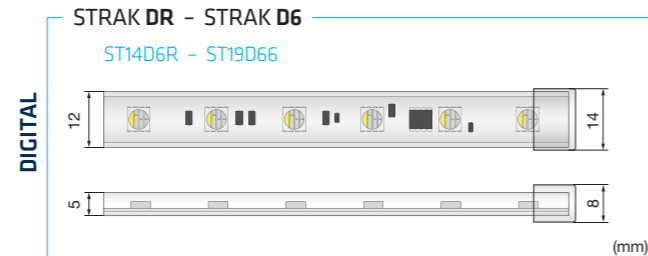
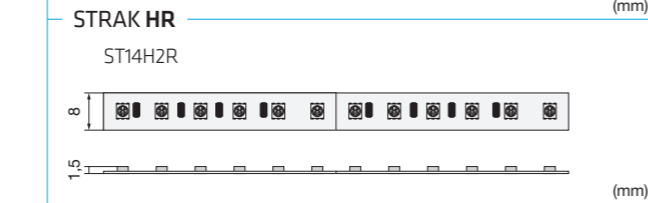
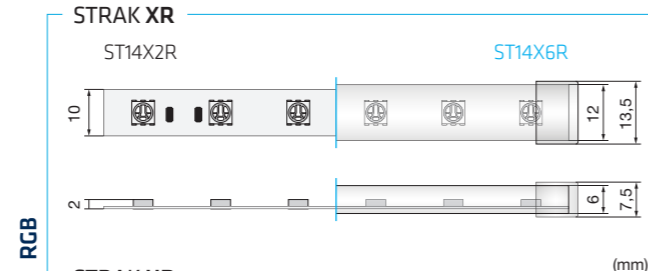
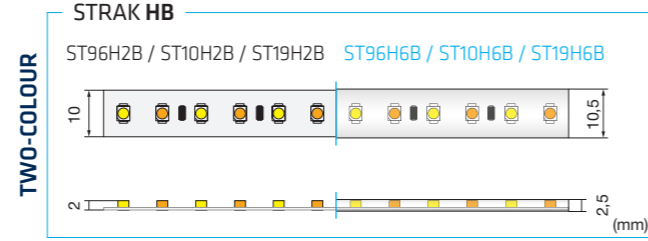

# PROFILES EFFECTIVE DIMENSIONS / DIMENSIONI UTILI DEI PROFILI

E.g.: PF1414SP Maximum internal width x height = 10 x 12,6 mm / Larghezza x altezza massima interne = 10 x 12,6 mm

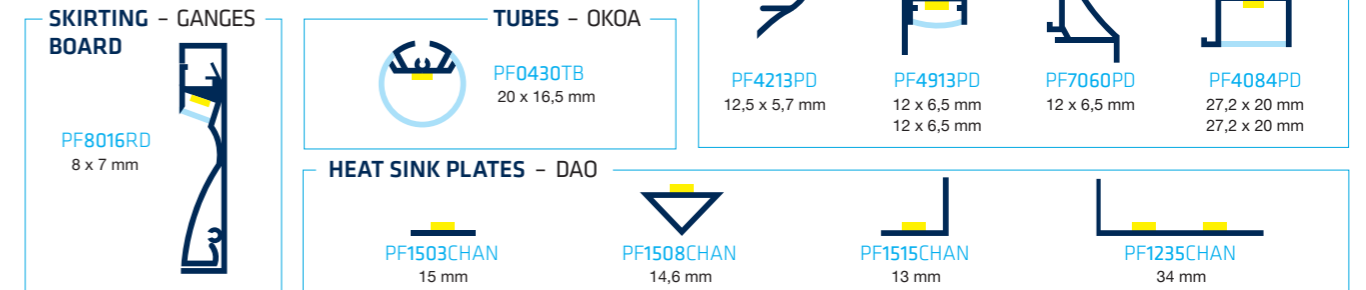
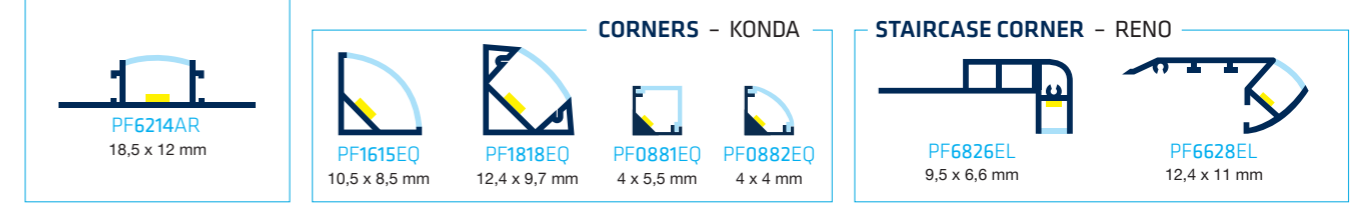
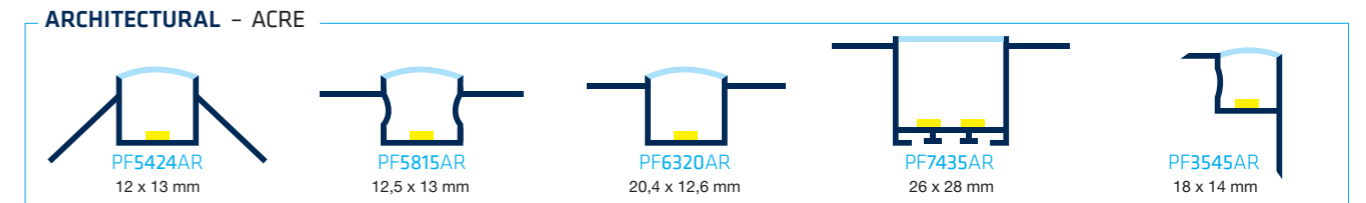
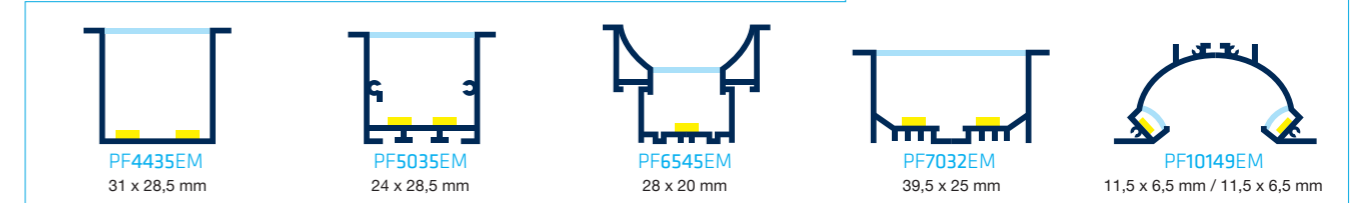
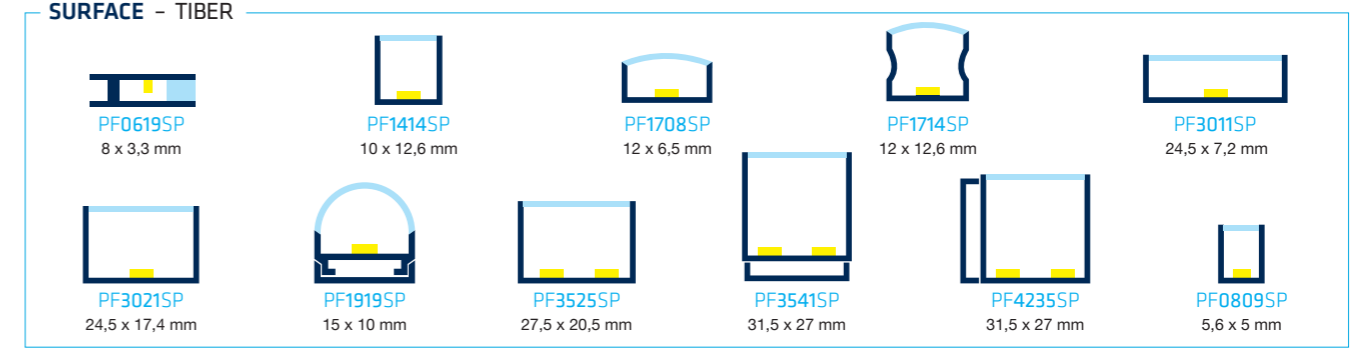

# Profiles

## Profili

Cut to size / Taglio su misura

Customised finish / Finitura personalizzata

We find the ideal profile for your project / Troviamo il profilo adatto al tuo progetto.

## Custom

Aluminium profiles make it possible to adapt the installation of LED strips to the facilities, besides protecting the strips, thus achieving professional finishes with style. They dissipate heat, making the strips more durable. In addition, among their wide variety, you will find the one that best suits your project: surface, recessed, suspension mounted, architectural, for corners, staircases, floors, walls or skirting boards.

100% customisable, our profiles can be cut and finished according to the project.

LED strip assembly is very simple and we have accessories and diffusers (opal or transparent) to carry out the complete installation. They are ideal for linear lighting or for decorating spaces, staircases, floors, façades, display cabinets and shelves, cupboards, drawers, etc.

Their possibilities go as far as your imagination can take you. If you need help or advice, please contact our technical department.

*I profili di alluminio permettono di collocare al meglio le strip LED in diversi tipi di installazioni e al tempo stesso le proteggono e ne aumentano la durata, migliorando la dissipazione del calore. Rappresentano una soluzione professionale e decorativa per diverse applicazioni, e la loro varietà ti permette di scegliere l'opzione che meglio si adatta al tuo progetto: da superficie, da incasso, sospeso, architettonica, angolare, per scale, pavimento, parete o battiscopa.*

*Installare la strip LED è molto semplice e abbiamo a disposizione anche accessori e diffusori (opali o trasparenti) per realizzare l'installazione completa. Sono perfetti per illuminare in maniera lineare o decorare ambienti, scale, pavimenti, facciate, vetrine, mensole, armadi, cassette, ecc.*

*Le possibilità di utilizzo arrivano fin dove arriva la tua immaginazione. Se hai bisogno di aiuto o di una consulenza, mettiti in contatto con il nostro ufficio tecnico.*

PRO TIBER PF0619SP

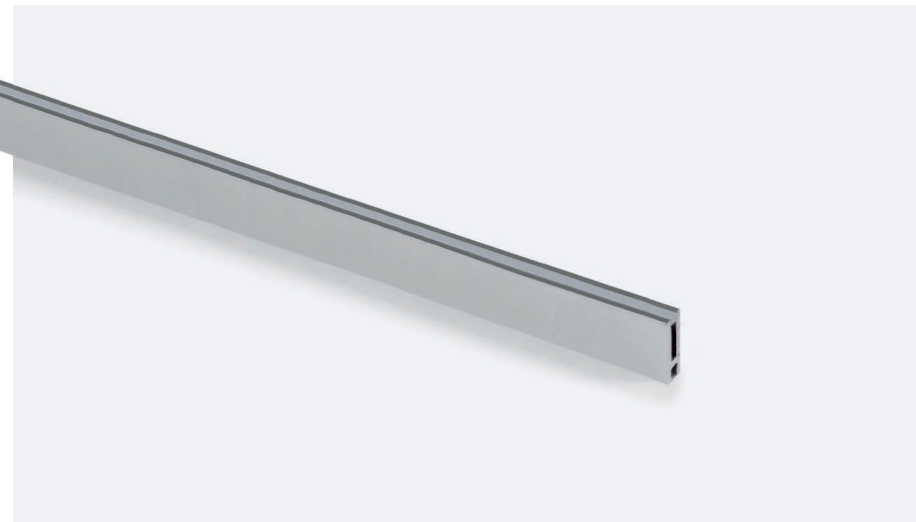

**12 W/m**  
Max. Power

**8 mm**  
Max. Width

**3,3 mm**  
Max. Height

Effective dimensions  
Dimensioni utili



Aluminium profile for surface mounting and special for side strip, 6x19 mm.  
Profilo di alluminio da superficie speciale per strip LED laterale, 6x19 mm.

Cut to size  
Taglio su misura

- AL 6063A BODY
- PC DIFFUSER
- 158 g/m
- IP20
- IK08
- PL RAL9007
- NE RAL9005
- BL RAL9016

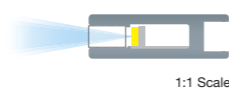
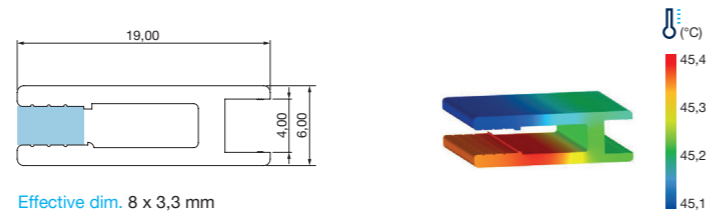

2 m	Custom	max.
PF0619SPAN	PF0619SPCMAN	12 W/m
PF0619SPNE	PF0619SPCMNE	12 W/m
PF0619SPBL	PF0619SPCMBL	12 W/m

Which measure do you need? Contact us!  
Di che misura hai bisogno? Contattaci!

PRO TIBER PF1414SP



**19,2 W/m**  
Max. Power

**10 mm**  
Max. Width

**12,6 mm**  
Max. Height

Effective dimensions  
Dimensioni utili



Aluminium profile for surface mounting, 14x14 mm.  
Profilo di alluminio da superficie, 14x14 mm.

Cut to size  
Taglio su misura

- AL 6063A BODY
- PC DIFFUSER
- 136 g/m
- IP20
- IK08
- PL RAL9007
- NE RAL9005
- BL RAL9016

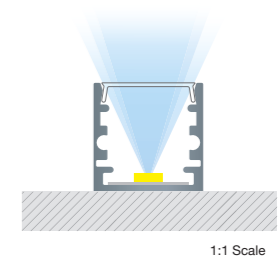
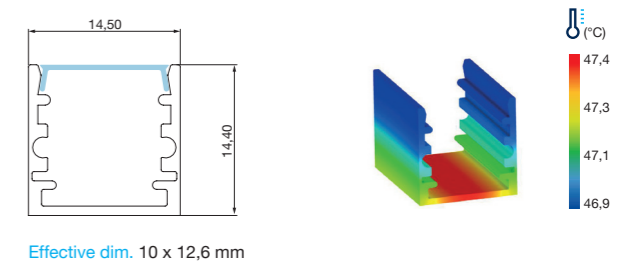

• ACCESSORIES INCLUDED

CAPS / TAPPI

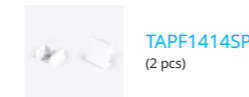

CLIPS / CLIP



2 m	Custom	max.
PF1414SPAN	PF1414SPCMAN	19,2 W/m
PF1414SPNE	PF1414SPCMNE	19,2 W/m
PF1414SPBL	PF1414SPCMBL	19,2 W/m

Which measure do you need? Contact us!  
Di che misura hai bisogno? Contattaci!



PRO TIBER PF1708SP



⚡ 19,2 W/m  
Max. Power.

📏 12 mm  
Max. Width

📏 6,5 mm  
Max. Height

Effective dimensions  
Dimensioni utili



Cut to size  
Taglio su misura

Aluminium profile for surface mounting, 17x8 mm.  
Profilo di alluminio da superficie, 17x8 mm.

- AL 6063A BODY
- PC DIFFUSER
- 114 g/m
- IP20
- IK08
- PL RAL9007
- NE RAL9005
- BL RAL9016

• ACCESSORIES INCLUDED

- CAPS / TAPPI: TAPF1708SP (2 pcs)
- CLIPS / CLIP: CLPF1708SP (4 pcs)

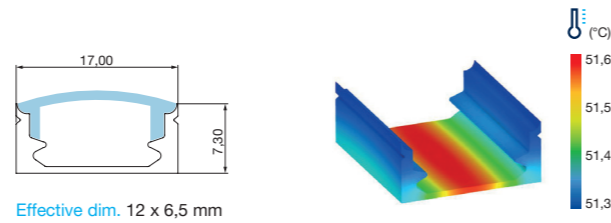

• OPTIONAL ACCESSORIES

- DIFFUSERS / DIFFUSORI: DFP1122C1M (1 m)
- CONNECTION / UNIONE: APF5015
- DFP01127VEC1M
- DFP01124ROC1M
- DFP01123NEC1M
- DFP01126AZC1M
- DFP01125NAC1M (1 m)

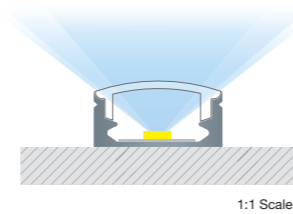

2 m	Custom	max.
PF1708SPAN	PF1708SPCMAN	RAL 9007 19,2 W/m
PF1708SPNE	PF1708SPCMNE	RAL 9005 19,2 W/m
PF1708SPBL	PF1708SPCMBL	RAL 9016 19,2 W/m

Which measure do you need? Contact us!  
Di che misura hai bisogno? Contattaci!

PRO TIBER PF1714SP

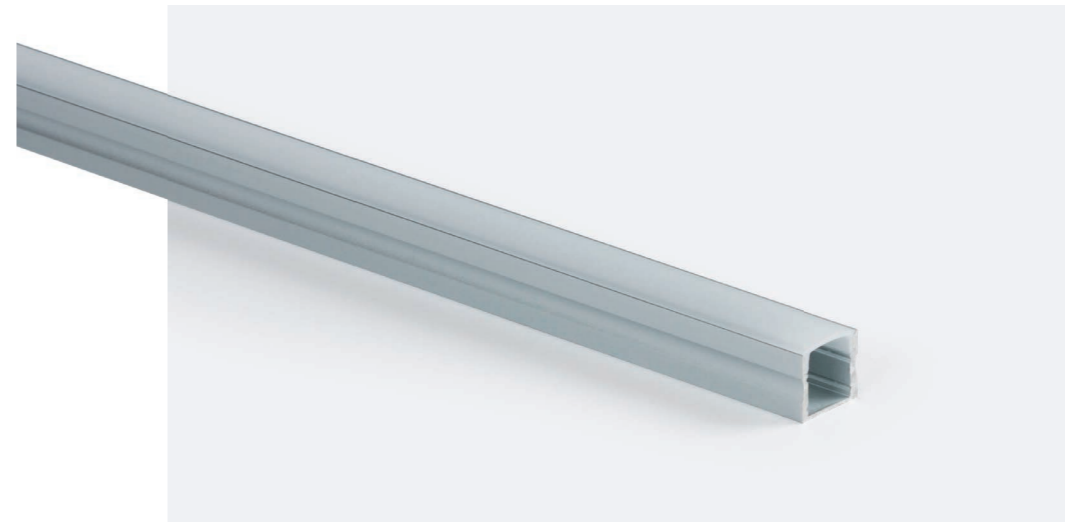

⚡ 19,2 W/m  
Max. Power.

📏 12 mm  
Max. Width

📏 12,6 mm  
Max. Height

Effective dimensions  
Dimensioni utili



Cut to size  
Taglio su misura

Aluminium profile for surface mounting, 17x14 mm.  
Profilo di alluminio da superficie, 17x14 mm.

- AL 6063A BODY
- PC DIFFUSER
- 180 g/m
- IP20
- IK08
- PL RAL9007
- NE RAL9005
- BL RAL9016

• ACCESSORIES INCLUDED

- CAPS / TAPPI: TAPF1714SP (2 pcs)
- CLIPS / CLIP: CLPF1714SP (4 pcs)

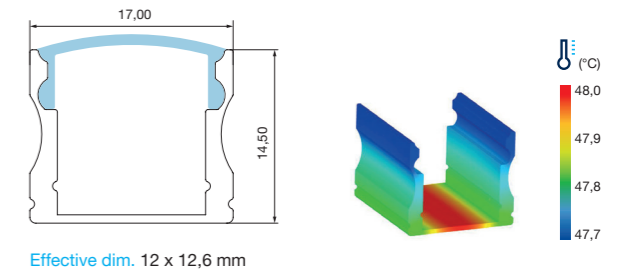

• OPTIONAL ACCESSORIES

- DIFFUSERS / DIFFUSORI: DFP1122C1M (1 m)
- DFP01127VEC1M
- DFP01124ROC1M
- DFP01123NEC1M
- DFP01126AZC1M
- DFP01125NAC1M (1 m)

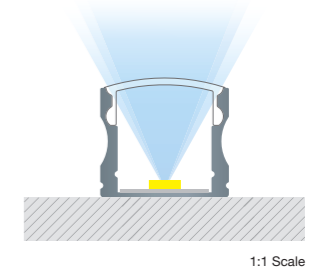

2 m	Custom	max.
PF1714SPAN	PF1714SPCMAN	RAL 9007 19,2 W/m
PF1714SPNE	PF1714SPCMNE	RAL 9005 19,2 W/m
PF1714SPBL	PF1714SPCMBL	RAL 9016 19,2 W/m

Which measure do you need? Contact us!  
Di che misura hai bisogno? Contattaci!

PRO TIBER PF3011SP

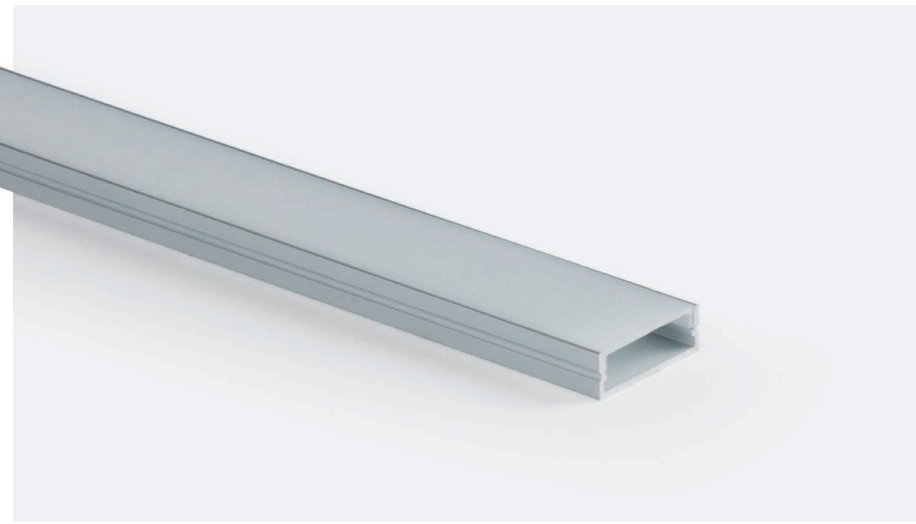

⚡ 19,2 W/m  
Max. Power.

📏 24,5 mm  
Max. Width

📏 7,2 mm  
Max. Height

Effective dimensions  
Dimensioni utili



Aluminium profile for surface mounting, 30x11 mm.  
Profilo di alluminio da superficie, 30x11 mm.

Cut to size  
Taglio su misura

- AL 6063A BODY
- PC DIFFUSER
- 214 g/m
- IP20
- IK08
- PL RAL9007
- NE RAL9005
- BL RAL9016

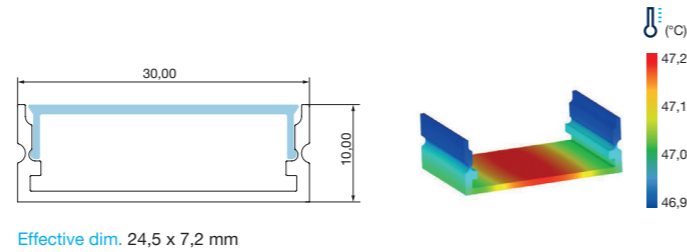

• ACCESSORIES INCLUDED

- CAPS / TAPPI: TAPF3011SP (2 pcs)
- CLIPS / CLIP: CLPF3011SP (4 pcs)

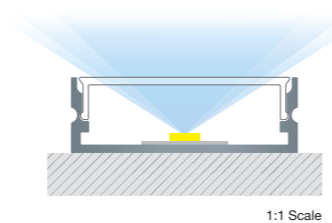

2 m	Custom	max.
PF3011SPAN	PF3011SPCMAN	RAL 9007 19,2 W/m
PF3011SPNE	PF3011SPCMNE	RAL 9005 19,2 W/m
PF3011SPBL	PF3011SPCMBL	RAL 9016 19,2 W/m

Which measure do you need? Contact us!  
Di che misura hai bisogno? Contattaci!

PRO TIBER PF3021SP

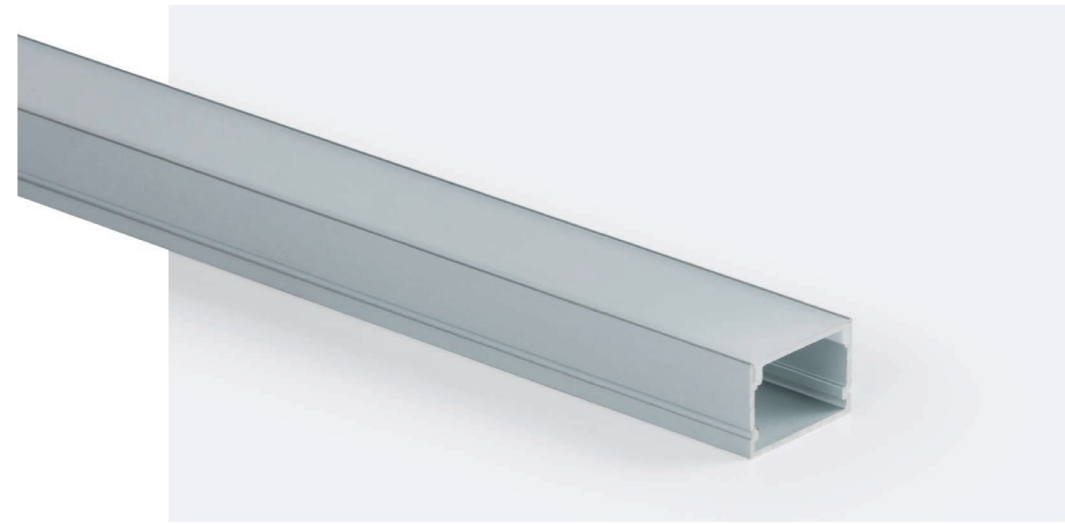

⚡ 19,2 W/m  
Max. Power.

📏 24,5 mm  
Max. Width

📏 17,4 mm  
Max. Height

Effective dimensions  
Dimensioni utili



Aluminium profile for surface mounting, 30x21 mm.  
Profilo di alluminio da superficie, 30x21 mm.

Cut to size  
Taglio su misura

- AL 6063A BODY
- PC DIFFUSER
- 286 g/m
- IP20
- IK08
- PL RAL9007
- NE RAL9005
- BL RAL9016

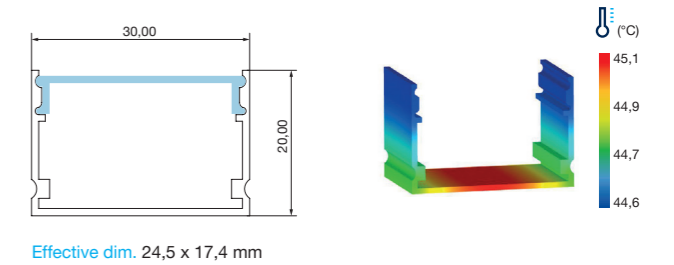

• ACCESSORIES INCLUDED

- CAPS / TAPPI: TAPF3021SP (2 pcs)
- CLIPS / CLIP: CLPF3021SP (4 pcs)

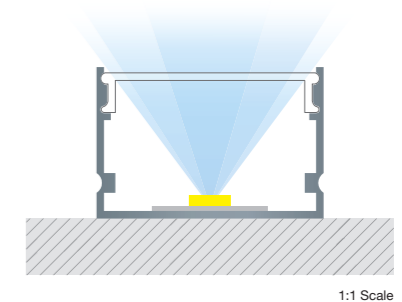

2 m	Custom	max.
PF3021SPAN	PF3021SPCMAN	RAL 9007 19,2 W/m
PF3021SPNE	PF3021SPCMNE	RAL 9005 19,2 W/m
PF3021SPBL	PF3021SPCMBL	RAL 9016 19,2 W/m

Which measure do you need? Contact us!  
Di che misura hai bisogno? Contattaci!

PRO TIBER PF1919SP



⚡ 19,2 W/m  
Max. Power.

15 mm  
Max. Width

10 mm  
Max. Height

Effective dimensions  
Dimensioni utili

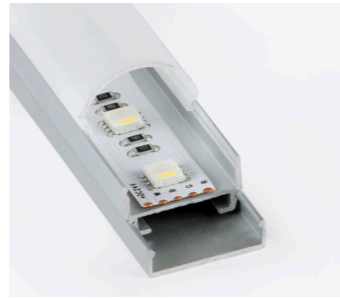

Cut to size  
Taglio su misura

Aluminium profile for surface mounting, curved diffuser, 19x19 mm.

Profilo di alluminio da superficie, diffusore curvo, 19x19 mm.

- AL 6063A BODY
- PC DIFFUSER
- 166 g/m
- IP20
- IK08
- PL RAL9007
- NE RAL9005
- BL RAL9016

• ACCESSORIES INCLUDED

CAPS / TAPPI



• OPTIONAL ACCESSORIES

SUSPENSION / SOSPENSIONE

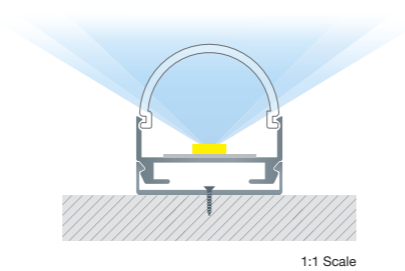
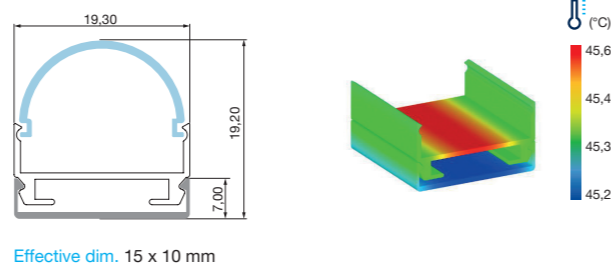

2 m	Custom	max.
PF1919SPAN	PF1919SPCMAN	19,2 W/m
PF1919SPNE	PF1919SPCMNE	19,2 W/m
PF1919SPBL	PF1919SPCMBL	19,2 W/m

Which measure do you need? Contact us!  
Di che misura hai bisogno? Contattaci!

PRO TIBER PF3525SP

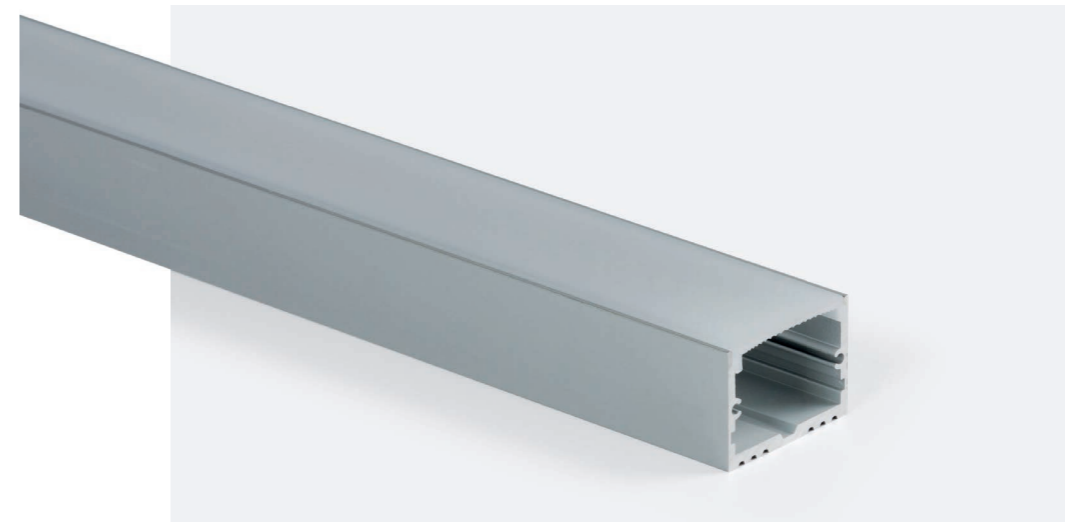

⚡ 38,4 W/m  
Max. Power.

27,5 mm  
Max. Width

20,5 mm  
Max. Height

Effective dimensions  
Dimensioni utili



Cut to size  
Taglio su misura

Aluminium profile for surface mounting, 35x25 mm.

Profilo di alluminio da superficie, 35x25 mm.

- AL 6063A BODY
- PC DIFFUSER
- 502 g/m
- IP20
- IK08
- PL RAL9007
- NE RAL9005
- BL RAL9016

• ACCESSORIES INCLUDED

CAPS / TAPPI

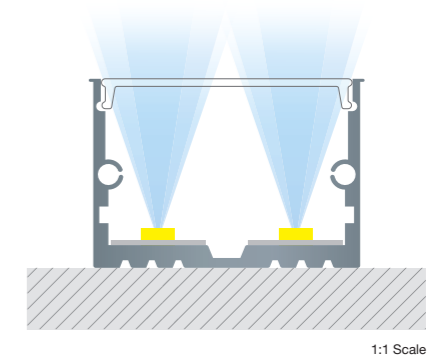
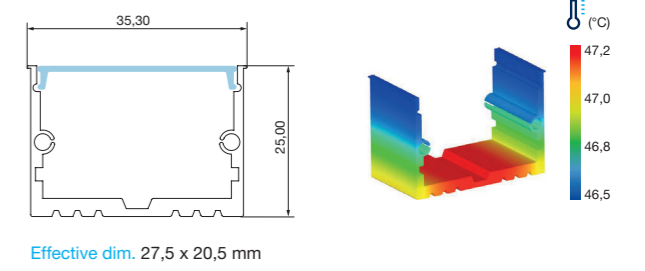

2 m	Custom	max.
PF3525SPAN	PF3525SPCMAN	38,4 W/m
PF3525SPNE	PF3525SPCMNE	38,4 W/m
PF3525SPBL	PF3525SPCMBL	38,4 W/m

Which measure do you need? Contact us!  
Di che misura hai bisogno? Contattaci!

PRO TIBER PF3541SP



⚡ **38,4 W/m**  
Max. Power.

📏 **31,5 mm**  
Max. Width

📏 **27 mm**  
Max. Height

Effective dimensions  
Dimensioni utili



Cut to size  
Taglio su misura

Aluminium profile for surface mounting, side lighting, 35x41 mm.  
Profilo di alluminio da superficie, illuminazione laterale, 35x41 mm.

- AL 6063A BODY
- PC DIFFUSER
- 774 g/m
- IP20
- IK08
- PL RAL9007
- NE RAL9005
- BL RAL9016

• ACCESSORIES INCLUDED

CAPS / TAPPI



• OPTIONAL ACCESSORIES

SUSPENSION / SOSPENSIONE

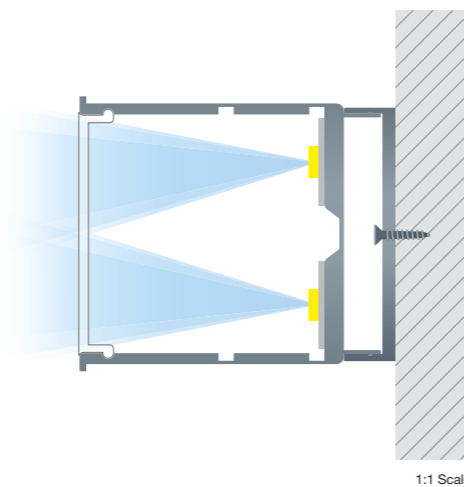
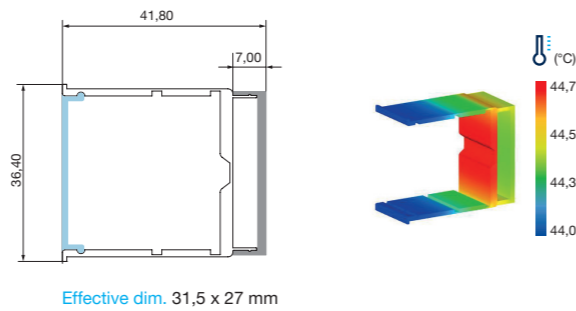

2 m	Custom	max.
PF3541SPAN	PF3541SPCMAN	RAL 9007 38,4 W/m
PF3541SPNE	PF3541SPCMNE	RAL 9005 38,4 W/m
PF3541SPBL	PF3541SPCMBL	RAL 9016 38,4 W/m

Which measure do you need? Contact us!  
Di che misura hai bisogno? Contattaci!

PRO TIBER PF4235SP



⚡ **38,4 W/m**  
Max. Power.

📏 **31,5 mm**  
Max. Width

📏 **27 mm**  
Max. Height

Effective dimensions  
Dimensioni utili



Cut to size  
Taglio su misura

Aluminium profile for surface mounting, 42x35 mm.  
Profilo di alluminio da superficie, 42x35 mm.

- AL 6063A BODY
- PC DIFFUSER
- 736 g/m
- IP20
- IK08
- PL RAL9007
- NE RAL9005
- BL RAL9016

• OPTIONAL ACCESSORIES

CAPS / TAPPI

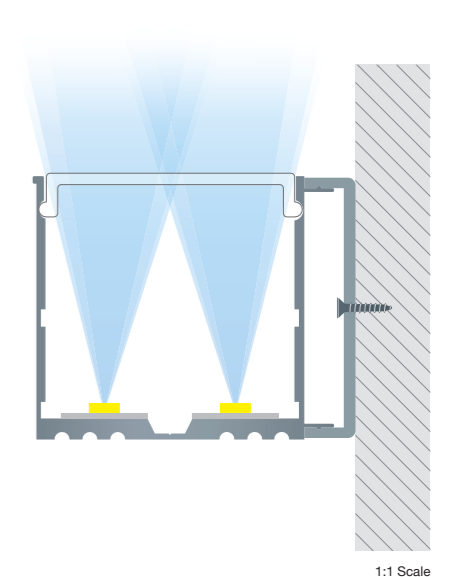
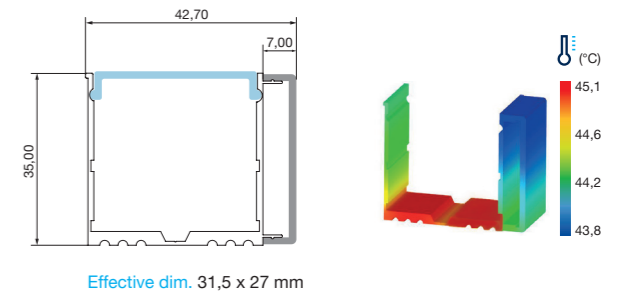

2 m	Custom	max.
PF4235SPAN	PF4235SPCMAN	RAL 9007 38,4 W/m
PF4235SPNE	PF4235SPCMNE	RAL 9005 38,4 W/m
PF4235SPBL	PF4235SPCMBL	RAL 9016 38,4 W/m

Which measure do you need? Contact us!  
Di che misura hai bisogno? Contattaci!

PRO TIBER PF0809SP



NEW

⚡ 9,6 W/m  
Max. Power.

5,6 mm  
Max. Width

5 mm  
Max. Height

Effective dimensions  
Dimensioni utili



Cut to size  
Taglio su misura

Aluminium profile for surface mounting, extra thin, 8x9 mm.  
Profilo di alluminio da superficie, extrasottile, 8x9 mm.

- AL**  
5063A  
BODY
- PC**  
DIFFUSER
- 130 g/m**
- IP20**
- IK08**
- PL**  
RAL9007
- NE**  
RAL9005
- BL**  
RAL9016

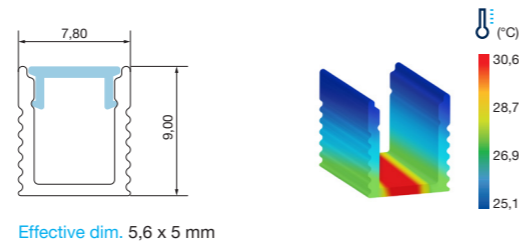

• ACCESSORIES INCLUDED

CAPS / TAPPI



CLIPS / CLIP

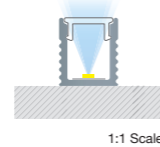

2 m	Custom		max.
PF0809SPAN	PF0809SPCMAN	■ RAL 9007	9,6 W/m
PF0809SPNE	PF0809SPCMNE	■ RAL 9005	9,6 W/m
PF0809SPBL	PF0809SPCMBL	□ RAL 9016	9,6 W/m

Which measure do you need? Contact us!  
Di che misura hai bisogno? Contattaci!



Surface profiles are a simple and practical solution that adds an aesthetic and functional touch to every space. Moreover, they are ideal to light up the interior of wardrobes and for less complex installations that don't need previous work.

*I profili di superficie sono una soluzione semplice e pratica che aggiunge un tocco estetico e funzionale a qualsiasi spazio. Inoltre, sono perfetti per illuminare l'interno di armadi e per installazioni poco complesse, che non hanno bisogno di lavori preventivi.*



This profile, strategically placed, improves the aesthetic of the space and, at the same time, it offers a practical solution for lighting. Its modern design is perfectly integrated in the environment, creating a welcoming and professional atmosphere. Its easy installation makes it the perfect choice to enhance the aspect and the style of this beauty salon.

*Questo profilo, collocato strategicamente, migliora l'estetica dello spazio e al tempo stesso offre una soluzione pratica per l'illuminazione. Il suo design moderno si integra perfettamente nell'ambiente, creando un'atmosfera accogliente e professionale. La facilità di installazione lo rende la scelta ideale per migliorare l'aspetto e lo stile di questo salone di bellezza.*



## PRO BENI PF2507SC



⚡ 19,2 W/m  
Max. Power.

📏 10,5 mm  
Max. Width

📏 6 mm  
Max. Height

Effective dimensions  
Dimensioni utili



Cut to size  
Taglio su misura

Aluminium profile for surface mounting, with curved flaps, 25x7 mm.  
Profilo di alluminio da superficie, con alette ricurve, 25x7 mm.

AL  
6063A  
BODYPC  
DIFFUSER

162 g/m

IP20

IK08

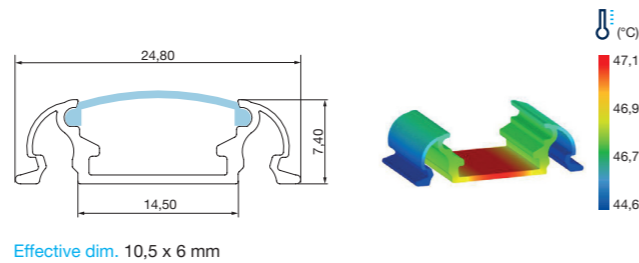
PL  
RAL9007NE  
RAL9005BL  
RAL9016

## • ACCESSORIES INCLUDED

## CAPS / TAPPI



TAPF2507SC  
(2 pcs)

## CLIPS / CLIP



CLPF2507SC  
(4 pcs)

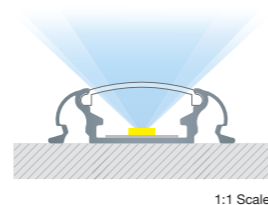

2 m	Custom	max.
PF2507SCAN	PF2507SCCMAN	RAL 9007 19,2 W/m
PF2507SCNE	PF2507SCCMNE	RAL 9005 19,2 W/m
PF2507SCBL	PF2507SCCMBL	RAL 9016 19,2 W/m

Which measure do you need? Contact us!  
Di che misura hai bisogno? Contattaci!

## PRO BENI PF3909SC



⚡ 19,2 W/m  
Max. Power.

📏 18 mm  
Max. Width

📏 5 mm  
Max. Height

Effective dimensions  
Dimensioni utili



Cut to size  
Taglio su misura

Aluminium profile for surface mounting, with curved flaps, 39x9 mm.  
Profilo di alluminio da superficie, con alette ricurve, 39x9 mm.

AL  
6063A  
BODYPC  
DIFFUSER

230 g/m

IP20

IK08

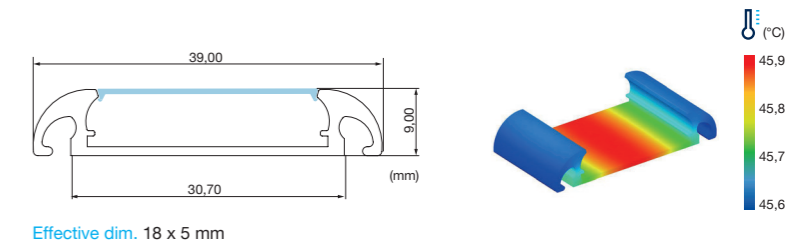
PL  
RAL9007NE  
RAL9005BL  
RAL9016

## • ACCESSORIES INCLUDED

## CAPS / TAPPI



TAPF3909SC  
(2 pcs)

## CLIPS / CLIP



CLPF3909SC  
(4 pcs)

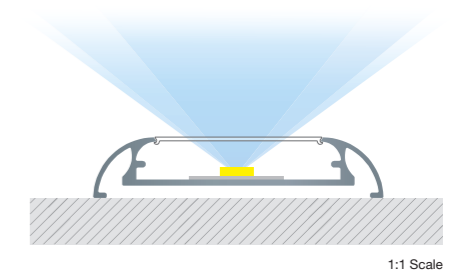

2 m	Custom	max.
PF3909SCAN	PF3909SCCMAN	RAL 9007 19,2 W/m
PF3909SCNE	PF3909SCCMNE	RAL 9005 19,2 W/m
PF3909SCBL	PF3909SCCMBL	RAL 9016 19,2 W/m

Which measure do you need? Contact us!  
Di che misura hai bisogno? Contattaci!

## PRO BENI PF5208SC



**19,2 W/m**  
Max. Power.
 **11 mm**  
Max. Width
 **6 mm**  
Max. Height

Effective dimensions  
Dimensioni utili

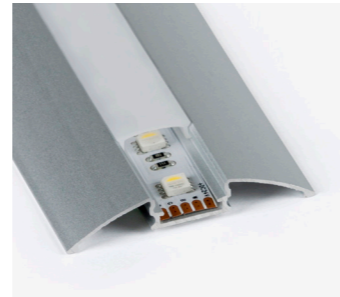

Cut to size  
Taglio su misura

Aluminium profile for surface mounting, with curved flaps, 52x8 mm.  
Profilo di alluminio da superficie, con alette ricurve, 52x8 mm.

AL  
5063A  
BODYPC  
DIFFUSER

176 g/m

IP20

IK08

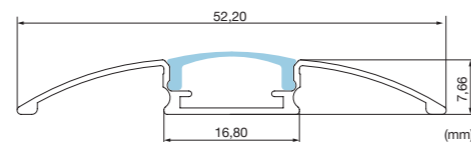
PL  
RAL9007NE  
RAL9005BL  
RAL9016

Effective dim. 11 x 6 mm

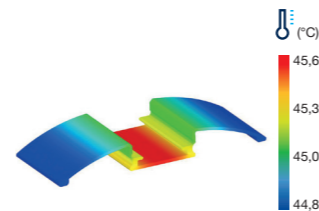

## • ACCESSORIES INCLUDED

## CAPS / TAPPI



TAPF5208SC  
(2 pcs)

## CLIPS / CLIP



CLPF5208SC  
(4 pcs)

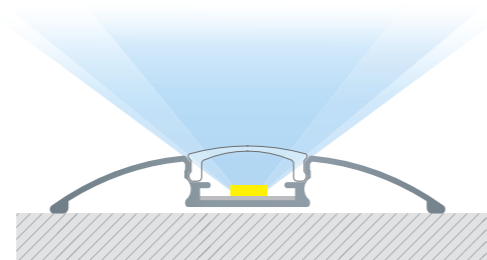

1:1 Scale

2 m	Custom		max.
PF5208SCAN	PF5208SCMAN	■ RAL 9007	19,2 W/m
PF5208SCNE	PF5208SCMNE	■ RAL 9005	19,2 W/m
PF5208SCBL	PF5208SCMBL	□ RAL 9016	19,2 W/m

Which measure do you need? Contact us!  
Di che misura hai bisogno? Contattaci!



The elegant design and the curved shape of this profile perfectly adapt to the surface, creating a gradual and pleasant transition, and adding a special touch to this kitchen. The easy installation makes it the perfect choice for those who seek a fusion of style and practicality in their kitchen.

*Il design elegante e la forma curva di questo profilo si adattano perfettamente alla superficie, creando una transizione graduale e gradevole, e donando un tocco speciale a questa cucina. La facilità di installazione lo rende una scelta perfetta per chi cerca una fusione tra stile e praticità nella propria cucina.*

## PRO NILE PF2314EM



**19,2 W/m**  
Max. Power.  
**12 mm**  
Max. Width  
**12,7 mm**  
Max. Height  
 Effective dimensions  
Dimensioni utili



Cut to size  
Taglio su misura

Aluminium profile for recessed mounting, 23x14 mm.  
Profilo di alluminio da incasso, 23x14 mm.

AL  
6063A  
BODYPC  
DIFFUSER

196 g/m

IP20

IK08

PL  
RAL9007NE  
RAL9005BL  
RAL9016

## • ACCESSORIES INCLUDED

## CAPS / TAPPI



TAPF2314EM  
(2 pcs)

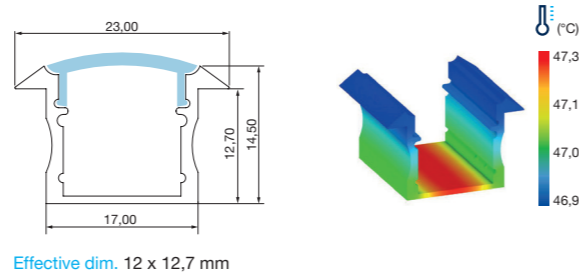

## • OPTIONAL ACCESSORIES

## DIFFUSERS / DIFFUSORI



DFP1122C1M  
(1 m)



■ DFP01127VEC1M  
 ■ DFP01124ROC1M  
 ■ DFP01123NEC1M  
 ■ DFP01126AZC1M  
 ■ DFP01125NAC1M  
 (1 m)

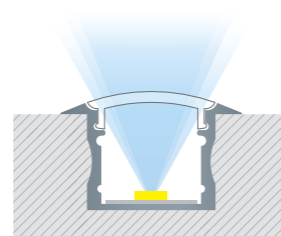

1:1 Scale

2 m	Custom	max.
PF2314EMAN	PF2314EMCMAN	■ RAL 9007 19,2 W/m
PF2314EMNE	PF2314EMCMNE	■ RAL 9005 19,2 W/m
PF2314EMBL	PF2314EMCMBL	□ RAL 9016 19,2 W/m

Which measure do you need? Contact us!  
Di che misura hai bisogno? Contattaci!

## PRO NILE PF2508EM

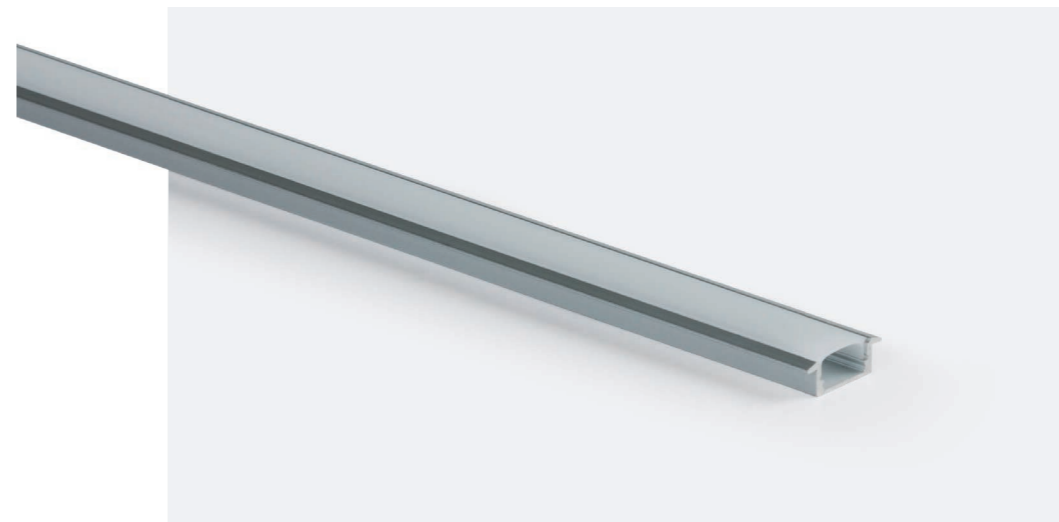

**19,2 W/m**  
Max. Power.  
**12 mm**  
Max. Width  
**6,5 mm**  
Max. Height  
 Effective dimensions  
Dimensioni utili



Cut to size  
Taglio su misura

Aluminium profile for recessed mounting, 25x8 mm.  
Profilo di alluminio da incasso, 25x8 mm.

AL  
6063A  
BODYPC  
DIFFUSER

130 g/m

IP20

IK08

PL  
RAL9007NE  
RAL9005BL  
RAL9016

## • ACCESSORIES INCLUDED

## CAPS / TAPPI



TAPF2508EM  
(2 pcs)

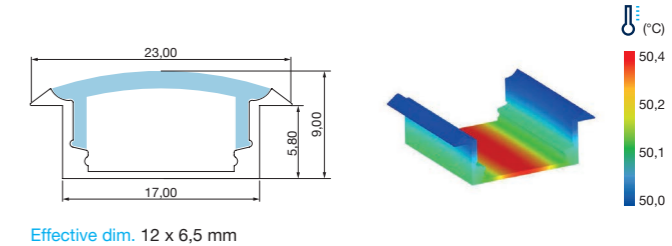

## • OPTIONAL ACCESSORIES

## DIFFUSERS / DIFFUSORI



DFP1122C1M  
(1 m)



■ DFP01127VEC1M  
 ■ DFP01124ROC1M  
 ■ DFP01123NEC1M  
 ■ DFP01126AZC1M  
 ■ DFP01125NAC1M  
 (1 m)

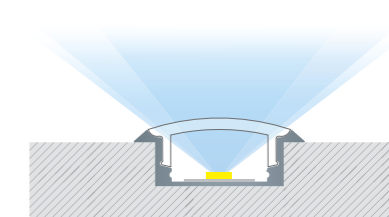

1:1 Scale

2 m	Custom	max.
PF2508EMAN	PF2508EMCMAN	■ RAL 9007 19,2 W/m
PF2508EMNE	PF2508EMCMNE	■ RAL 9005 19,2 W/m
PF2508EMBL	PF2508EMCMBL	□ RAL 9016 19,2 W/m

Which measure do you need? Contact us!  
Di che misura hai bisogno? Contattaci!



PRO NILE PF4435EM

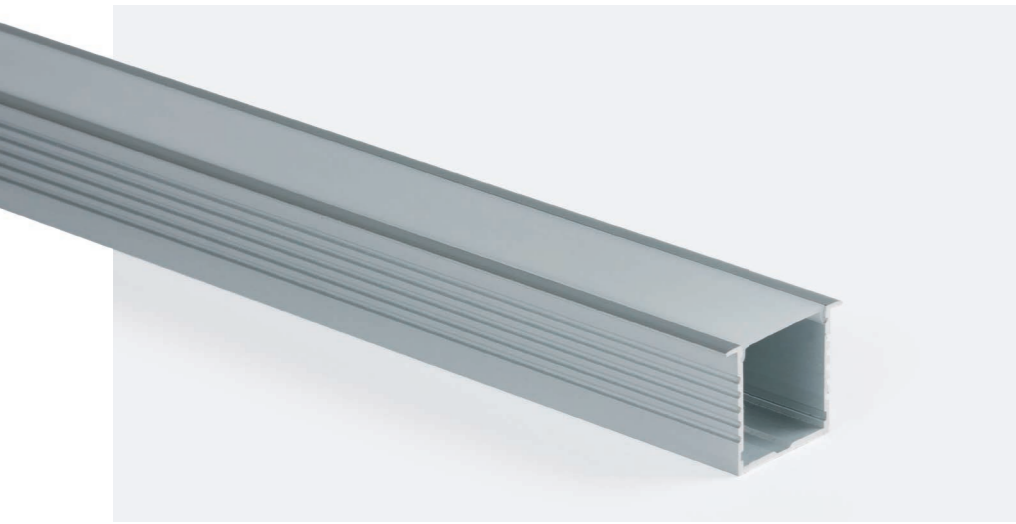

⚡ 38,4 W/m Max. Power.  
 31 mm Max. Width  
 28,5 mm Max. Height  
 Effective dimensions  
 Dimensioni utili



Aluminium profile for recessed mounting, 44x35 mm.  
 Profilo di alluminio da incasso, 44x35 mm.

Cut to size  
 Taglio su misura

- AL 6063A BODY
- PC DIFFUSER
- 510 g/m
- IP20
- IK08
- PL RAL9007
- NE RAL9005
- BL RAL9016

• ACCESSORIES INCLUDED

- CAPS / TAPPI
- TAPF4435EM (2 pcs)

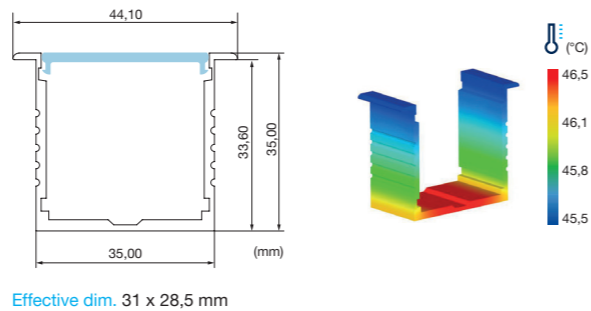

• OPTIONAL ACCESSORIES

- RECESSED / DA INCASSO
- APF5004

2 m	Custom	max.
PF4435EMAN	PF4435EMCMAN	RAL 9007 38,4 W/m
PF4435EMNE	PF4435EMCMNE	RAL 9005 38,4 W/m
PF4435EMBL	PF4435EMCMBL	RAL 9016 38,4 W/m

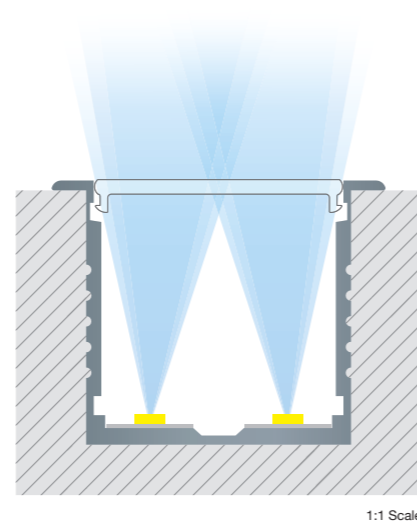

Which measure do you need? Contact us!  
 Di che misura hai bisogno? Contattaci!

PRO NILE PF5035EM

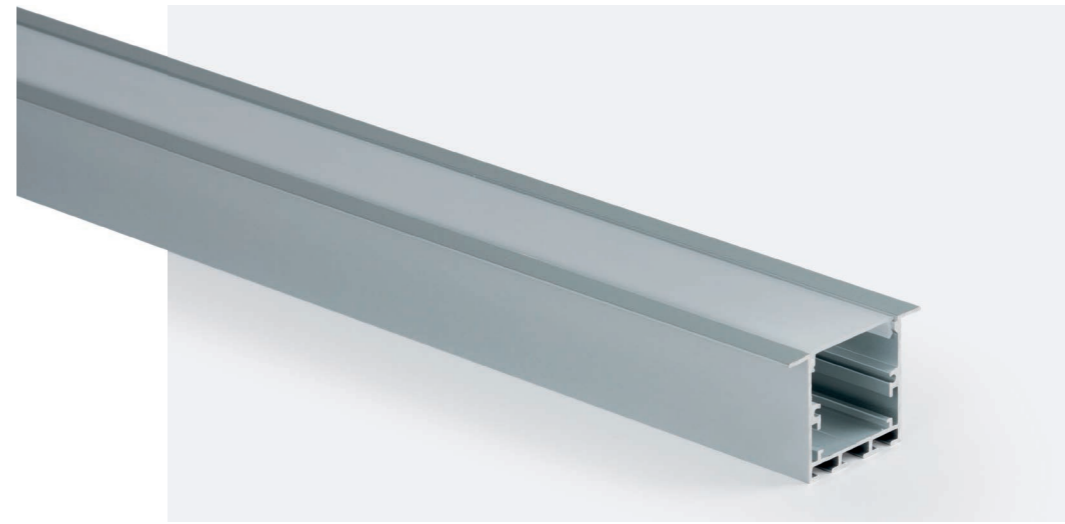

⚡ 38,4 W/m Max. Power.  
 24 mm Max. Width  
 28,5 mm Max. Height  
 Effective dimensions  
 Dimensioni utili

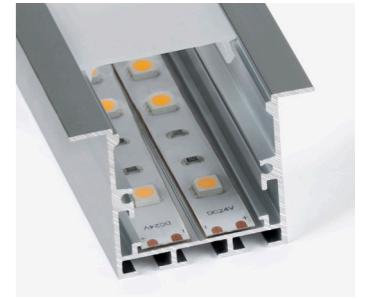

Aluminium profile for recessed mounting, 50x35 mm.  
 Profilo di alluminio da incasso, 50x35 mm.

Cut to size  
 Taglio su misura

- AL 6063A BODY
- PC DIFFUSER
- 546 g/m
- IP20
- IK08
- PL RAL9007
- NE RAL9005
- BL RAL9016

• ACCESSORIES INCLUDED

- CAPS / TAPPI
- TAPF5035EM (2 pcs)

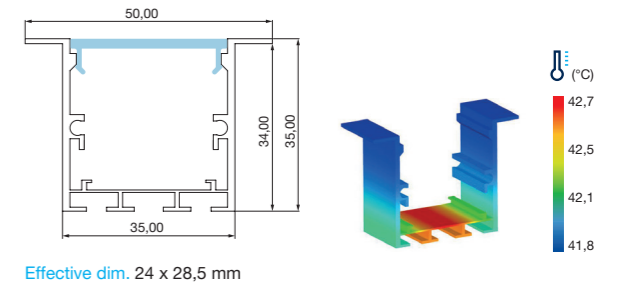

• OPTIONAL ACCESSORIES

- RECESSED / DA INCASSO
- APF5002
  - APF5005
  - APF5008
  - APF5009
- CLAMP / FISSAGGIO
- APF5003
  - APF5007
- DIFFUSERS / DIFFUSORI
- DFP1322C1M

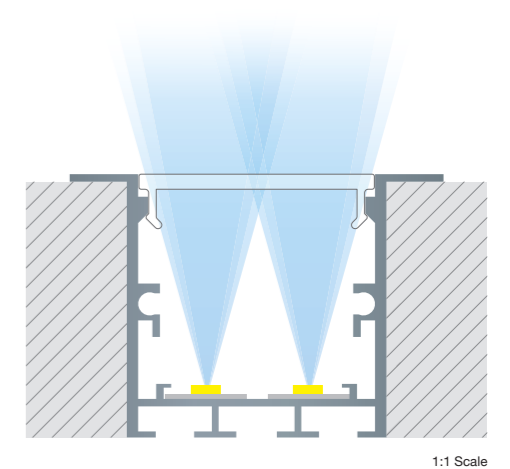

2 m	Custom	max.
PF5035EMAN	PF5035EMCMAN	RAL 9007 38,4 W/m
PF5035EMNE	PF5035EMCMNE	RAL 9005 38,4 W/m
PF5035EMBL	PF5035EMCMBL	RAL 9016 38,4 W/m

Which measure do you need? Contact us!  
 Di che misura hai bisogno? Contattaci!

## PRO NILE PF10149EM



**38,4 W/m**  
Max. Power.

**11,5 mm**  
Max. Width

**6,5 mm**  
Max. Height

Effective dimensions  
Dimensioni utili



Semi-circular aluminium profile for recessed mounting, indirect lighting, 2 LED strips, 101x49 mm.  
Profilo di alluminio semicircolare da incasso, illuminazione indiretta, 2 strip LED, 101x49 mm.

Cut to size  
Taglio su misura

AL  
6063A

BODY

PC

DIFFUSER

1150 g/m

IP20

IK08

PL

RAL9007

NE

RAL9005

BL

RAL9016

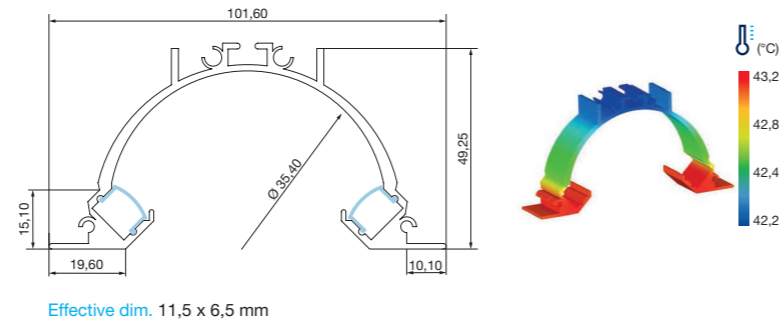

## • ACCESSORIES INCLUDED

## TAPAS / TAPAS



TAPF10149EM  
(2 pcs)

## • OPTIONAL ACCESSORIES

## RECESSED / DA INCASSO



APF5017

## CONNECTION / UNIONE



APF5005

## CLAMP / FISSAGGIO



APF5007



APF5008



APF5009

## SUSPENSION / SOSPENSIONE



APF5001 (1 m)  
APF5000 (2 m)  
APF5013 (3 m)

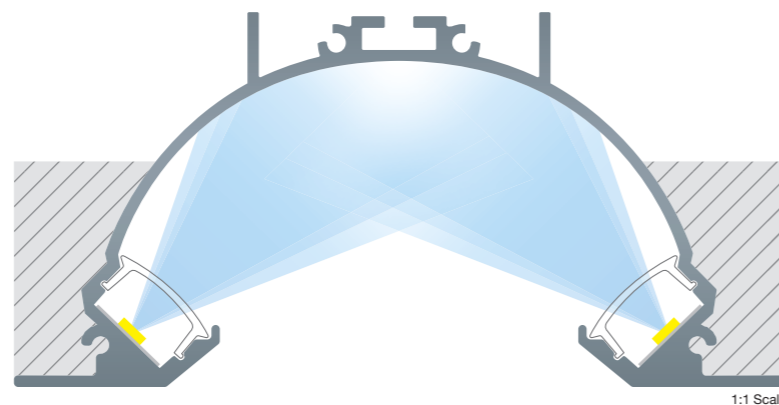

2 m	Custom	max.
PF10149EMAN	PF10149EMCMAN	■ RAL 9007 38,4 W/m
PF10149EMNE	PF10149EMCMNE	■ RAL 9005 38,4 W/m
PF10149EMBL	PF10149EMCMBL	□ RAL 9016 38,4 W/m

Which measure do you need? Contact us!  
Di che misura hai bisogno? Contattaci!



With an ideal mix between lighting and aesthetics, the recessed profile in the wall of this exhibition hall not only perfectly fulfils its practical functions but also performs a crucial role in creating a sophisticated atmosphere, thus improving the visitors' experience.

Con un mix perfetto tra illuminazione ed estetica, il profilo incassato nella parete di questa sala espositiva non solo compie efficacemente la sua funzione pratica, ma svolge anche un ruolo cruciale nel creare un'atmosfera sofisticata, migliorando così l'esperienza dei visitatori.



The recessed profile in the ceiling of this room creates a dynamic and avant-garde visual atmosphere. Its innovative and functional design adds a particular aesthetic element, turning the lighting into a unique artistic experience.

Il profilo incassato nel soffitto di questa stanza crea un'atmosfera visiva dinamica e d'avanguardia. Il suo design innovativo e funzionale aggiunge un elemento estetico particolare, trasformando l'illuminazione in un'esperienza artistica unica.



## PRO NILE PF6545EM

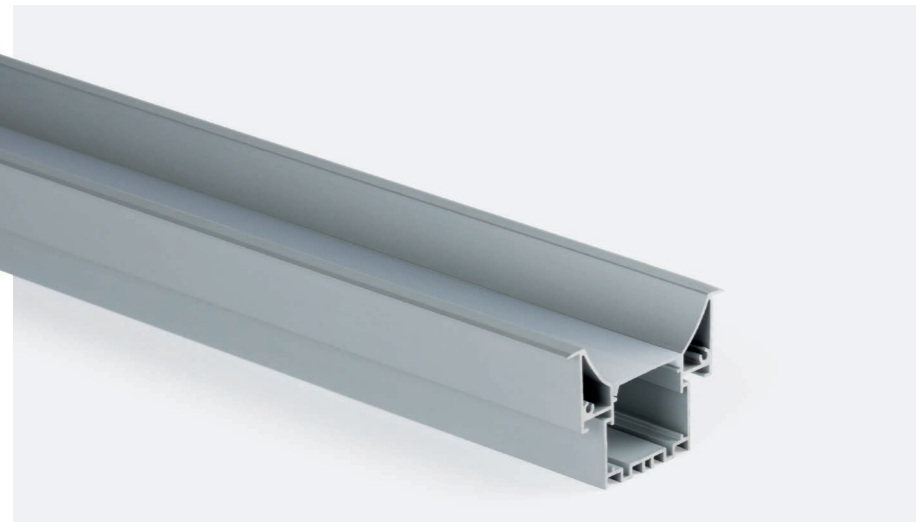

⚡ **19,2 W/m**  
Max. Power.

📏 **28 mm**  
Max. Width

📏 **20 mm**  
Max. Height

Effective dimensions  
Dimensioni utili

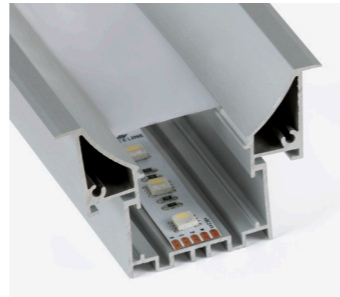

Cut to size  
Taglio su misura

Aluminium profile for recessed mounting, 65x45 mm.  
Profilo di alluminio da incasso, 65x45 mm.

AL  
6063A  
BODYPC  
DIFFUSER

770 g/m

IP20

IK08

PL  
RAL9007NE  
RAL9005BL  
RAL9016

## • ACCESSORIES INCLUDED

## CAPS / TAPPI



TAPF6545EM  
(2 pcs)

## • OPTIONAL ACCESSORIES

## CONNECTION / UNIONE



APF5005



APF5008



APF5009

## CLAMP / FISSAGGIO



APF5003



APF5007

## DIFFUSERS / DIFFUSORI



DFP1322C1M

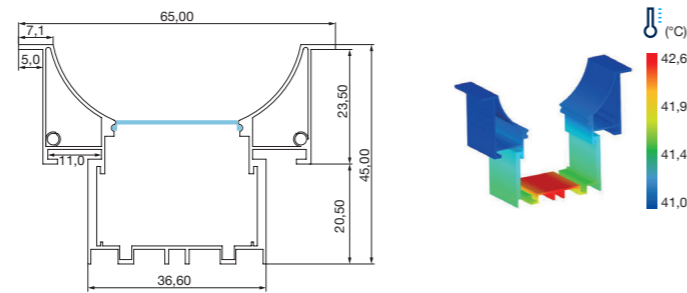

Effective dim. 28 x 20 mm

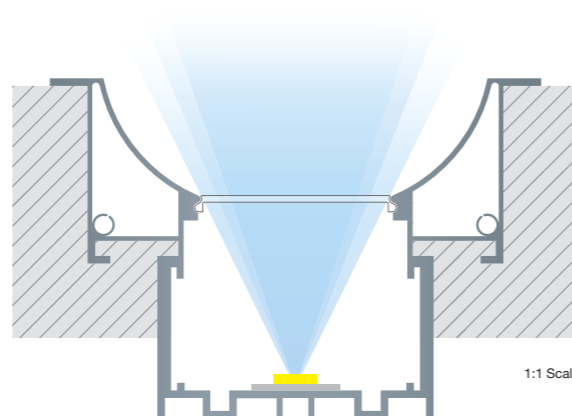

1:1 Scale

2 m	Custom	max.	
PF6545EMAN	PF6545EMCMAN	RAL 9007	19,2 W/m
PF6545EMNE	PF6545EMCMNE	RAL 9005	19,2 W/m
PF6545EMBL	PF6545EMCMBL	RAL 9016	19,2 W/m

Which measure do you need? Contact us!  
Di che misura hai bisogno? Contattaci!

## PRO NILE PF7032EM

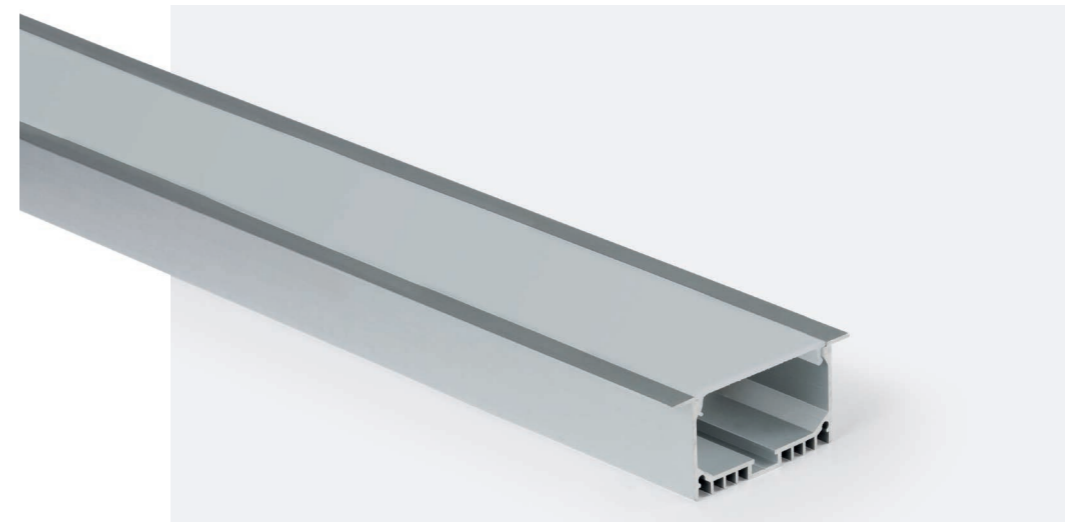

⚡ **38,4 W/m**  
Max. Power.

📏 **39,5 mm**  
Max. Width

📏 **25 mm**  
Max. Height

Effective dimensions  
Dimensioni utili



Cut to size  
Taglio su misura

Aluminium profile for recessed mounting, 70x32 mm.  
Profilo di alluminio da incasso, 70x32 mm.

AL  
6063A  
BODYPC  
DIFFUSER

758 g/m

IP20

IK08

PL  
RAL9007NE  
RAL9005BL  
RAL9016

## • ACCESSORIES INCLUDED

## CAPS / TAPPI



TAPF7032EM  
(2 pcs)

## • OPTIONAL ACCESSORIES

## RECESSED / DA INCASSO



APF5004



APF5006

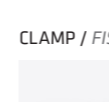

APF5007

## CONNECTION / UNIONE



APF5005



APF5008



APF5009

## CLAMP / FISSAGGIO



APF5007

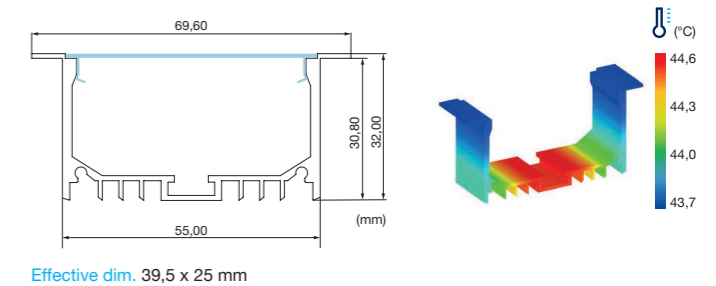

Effective dim. 39,5 x 25 mm

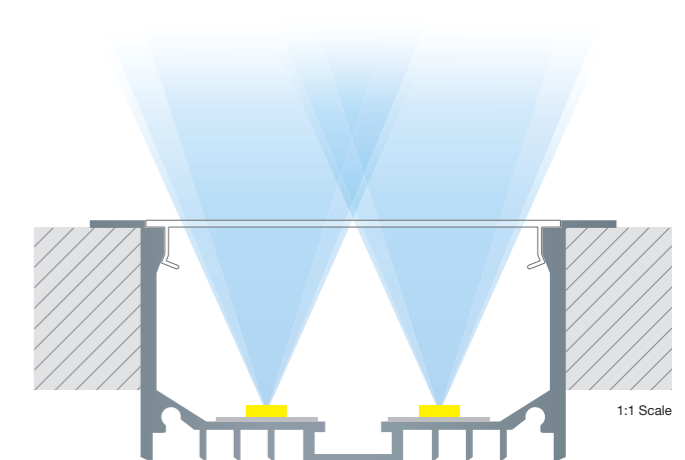

1:1 Scale

2 m	Custom	max.	
PF7032EMAN	PF7032EMCMAN	RAL 9007	38,4 W/m
PF7032EMNE	PF7032EMCMNE	RAL 9005	38,4 W/m
PF7032EMBL	PF7032EMCMBL	RAL 9016	38,4 W/m

Which measure do you need? Contact us!  
Di che misura hai bisogno? Contattaci!

## PRO NILE PF1312EM



NEW

**9,6 W/m**  
Max. Power

**5,8 mm**  
Max. Width

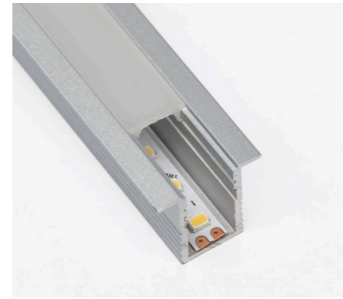
**8 mm**  
Max. Height
Effective dimensions  
Dimensioni utiliCut to size  
Taglio su misura 

Aluminium profile for recessed mounting, extra thin, 13x12 mm.

Profilo di alluminio da incasso, extrasottile, 13x12 mm.

AL  
6063A  
BODYPC  
DIFFUSER

160 g/m

IP20

IK08

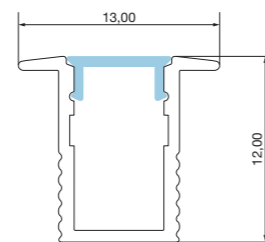
PL  
RAL9007NE  
RAL9005BL  
RAL9016

Effective dim. 5,8 x 8 mm

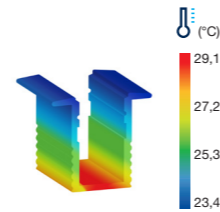

## • ACCESSORIES INCLUDED

CAPS / TAPPI

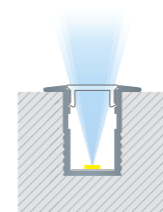
TAPF1312EM  
(2 pcs)

1:1 Scale

2 m	Custom		max.
PF1312EMAN	PF1312EMCMAN	■ RAL 9007	9,6 W/m
PF1312EMNE	PF1312EMCMNE	■ RAL 9005	9,6 W/m
PF1312EMBL	PF1312EMCMBL	□ RAL 9016	9,6 W/m

Which measure do you need? Contact us!  
Di che misura hai bisogno? Contattaci!

Fitting in a discreet and elegant way into the ceiling of the kitchen, this recessed profile with white finish provides a fresh and modern touch to the space. Moreover, the installation of two LED strips represents a high efficiency luminous solution, fundamental in this kind of zones.

*Integrandosi in modo discreto ed elegante nel soffitto della cucina, questo profilo da incasso con finitura bianca, dona all'ambiente un'aria fresca e moderna. Inoltre, le due strip LED installate offrono una soluzione luminosa di alto rendimento, fondamentale in questo tipo di spazi.*

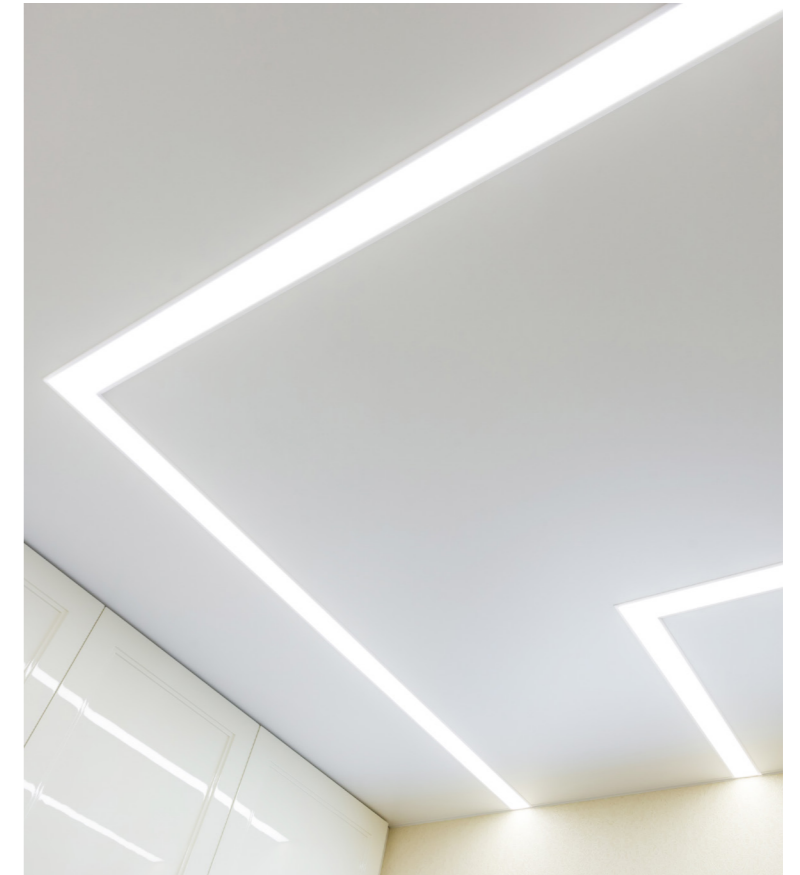

PRO LEAN PF2929CL



⚡ 19,2 W/m Max. Power.  
 📏 20,6 mm Max. Width  
 📏 15,7 mm Max. Height  
 Effective dimensions  
 Dimensioni utili



Aluminium profile for surface or suspension mounting, with curved diffuser, 29x29 mm.  
 Profilo di alluminio da superficie o sospensione, con diffusore curvo, 29x29 mm.

Cut to size  
 Taglio su misura

AL 6063A BODY | PC DIFFUSER | 228 g/m | IP20 | IK08 | PL RAL9007 | NE RAL9005 | BL RAL9016

• ACCESSORIES INCLUDED

CAPS / TAPPI  
 TAPF2929CL (2 pcs)

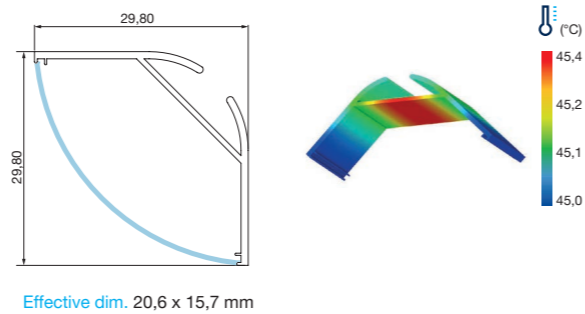

• OPTIONAL ACCESSORIES

CONNECTION / UNIONE | SUSPENSION / SOSPENSIONE  
 APF5005 | APF5001 (1 m)  
 APF5000 (2 m)  
 APF5013 (3 m)

CLAMP / FISSAGGIO  
 APF5007

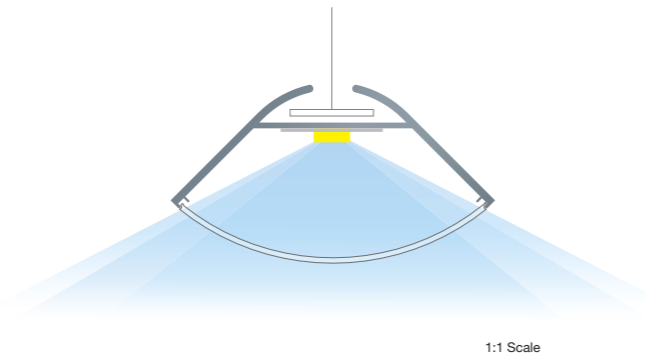

2 m	Custom	max.
PF2929CLAN	PF2929CLCMAN	RAL 9007 19,2 W/m
PF2929CLNE	PF2929CLCMNE	RAL 9005 19,2 W/m
PF2929CLBL	PF2929CLCMBL	RAL 9016 19,2 W/m

Which measure do you need? Contact us!  
 Di che misura hai bisogno? Contattaci!

PRO LEAN PF2930CL



⚡ 19,2 W/m Max. Power.  
 📏 20,6 mm Max. Width  
 📏 18,5 mm Max. Height  
 Effective dimensions  
 Dimensioni utili



Aluminium profile for surface or suspension mounting, with square diffuser, 29x30 mm.  
 Profilo di alluminio da superficie o sospensione, con diffusore quadrato, 29x30 mm.

Cut to size  
 Taglio su misura

AL 6063A BODY | PC DIFFUSER | 244 g/m | IP20 | IK08 | PL RAL9007 | NE RAL9005 | BL RAL9016

• ACCESSORIES INCLUDED

CAPS / TAPPI  
 TAPF2930CL (2 pcs)

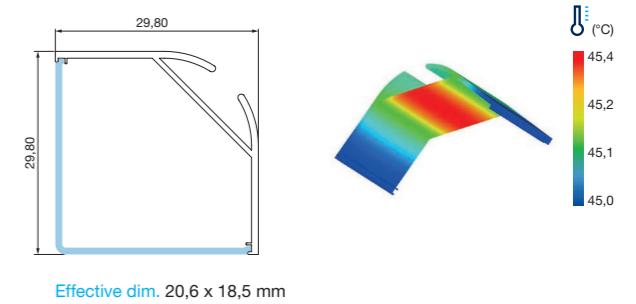

• OPTIONAL ACCESSORIES

CONNECTION / UNIONE | SUSPENSION / SOSPENSIONE  
 APF5005 | APF5001 (1 m)  
 APF5000 (2 m)  
 APF5013 (3 m)

CLAMP / FISSAGGIO  
 APF5007

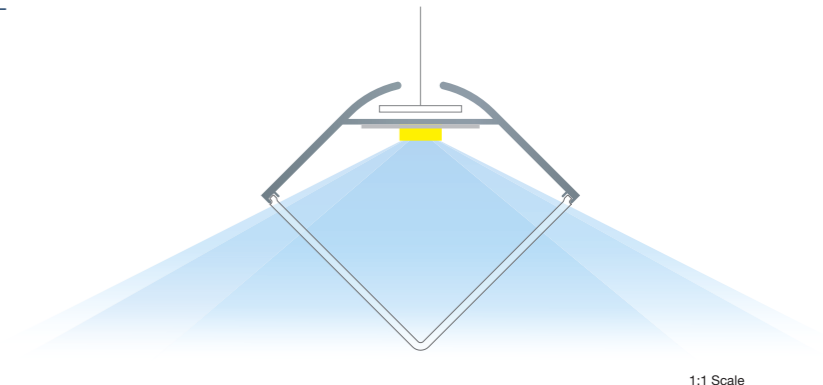

2 m	Custom	max.
PF2930CLAN	PF2930CLCMAN	RAL 9007 19,2 W/m
PF2930CLNE	PF2930CLCMNE	RAL 9005 19,2 W/m
PF2930CLBL	PF2930CLCMBL	RAL 9016 19,2 W/m

Which measure do you need? Contact us!  
 Di che misura hai bisogno? Contattaci!

PRO LEAN PF3535CL

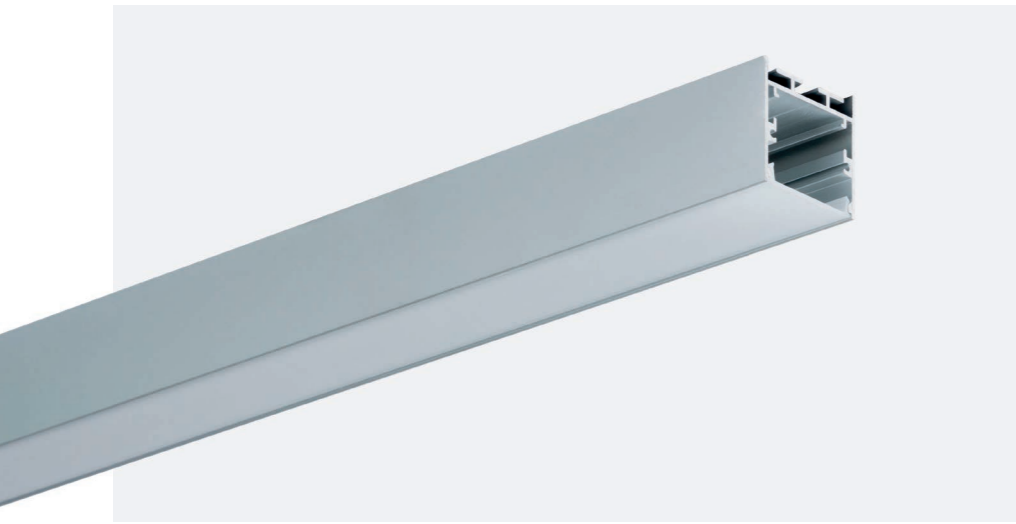

⚡ 38,4 W/m Max. Power.  
 📏 24 mm Max. Width  
 📏 25,5 mm Max. Height  
 Effective dimensions  
 Dimensioni utili



Cut to size  
 Taglio su misura

Aluminium profile for surface or suspension mounting, 35x35 mm.  
 Profilo di alluminio da superficie o sospensione, 35x35 mm.

- AL 6063A BODY
- PC DIFFUSER
- 552 g/m
- IP20
- IK08
- PL RAL9007
- NE RAL9005
- BL RAL9016

• ACCESSORIES INCLUDED

- CAPS / TAPPI
- TAPF3535CL (2 uds.)

• OPTIONAL ACCESSORIES

- RECESSED / DA INCASSO
- APF5002
- CONNECTION / UNIONE
- APF5005
  - APF5008
  - APF5009
- CLAMP / FISSAGGIO
- APF5007
- SUSPENSION / SOSPENSIONE
- APF5001 (1 m)
  - APF5000 (2 m)
  - APF5013 (3 m)
- DIFFUSERS / DIFFUSORI
- DFP1322C1M

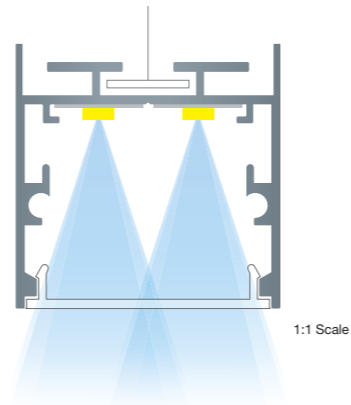
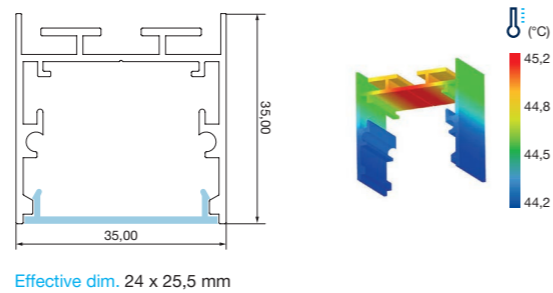

2 m	Custom	max.
PF3535CLAN	PF3535CLCMAN	RAL 9007 38,4 W/m
PF3535CLNE	PF3535CLCMNE	RAL 9005 38,4 W/m
PF3535CLBL	PF3535CLCMBL	RAL 9016 38,4 W/m

Which measure do you need? Contact us!  
 Di che misura hai bisogno? Contattaci!

PRO LEAN PF5074CL

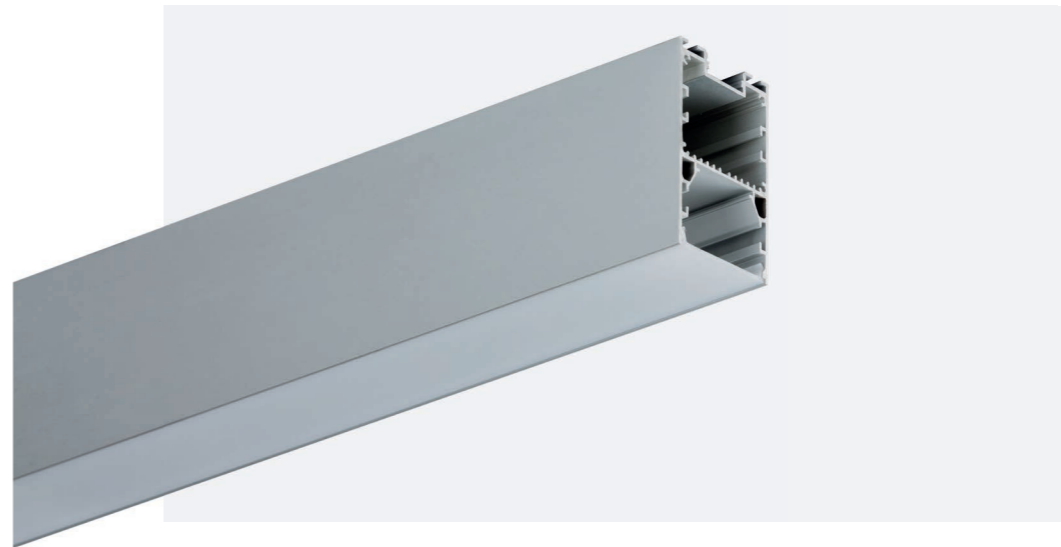

⚡ 38,4 W/m Max. Power.  
 📏 A | 18 mm Max. Width  
 📏 B | 28 mm Max. Height  
 📏 A | 8 mm Max. Height  
 📏 B | 30 mm Max. Height  
 Effective dimensions  
 Dimensioni utili

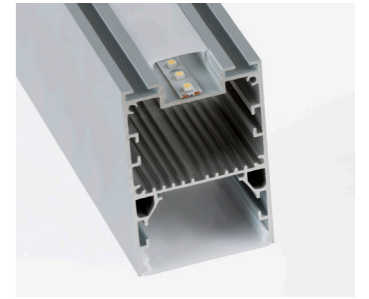

Cut to size  
 Taglio su misura

Aluminium profile for suspension mounting, double lighting (direct and indirect), 50x74 mm.  
 Profilo di alluminio per sospensione, doppia illuminazione (diretta e indiretta), 50x74 mm.

- AL 6063A BODY
- PC DIFFUSER
- 1486 g/m
- IP20
- IK08
- PL RAL9007
- NE RAL9005
- BL RAL9016

• ACCESSORIES INCLUDED

- CAPS / TAPPI
- TAPF5074CL (2 pcs)

• OPTIONAL ACCESSORIES

- CLAMP / FISSAGGIO
- APF5007
- CONNECTION / UNIONE
- APF5005
  - APF5008
  - APF5009
- SUSPENSION / SOSPENSIONE
- APF5001 (1 m)
  - APF5000 (2 m)
  - APF5013 (3 m)

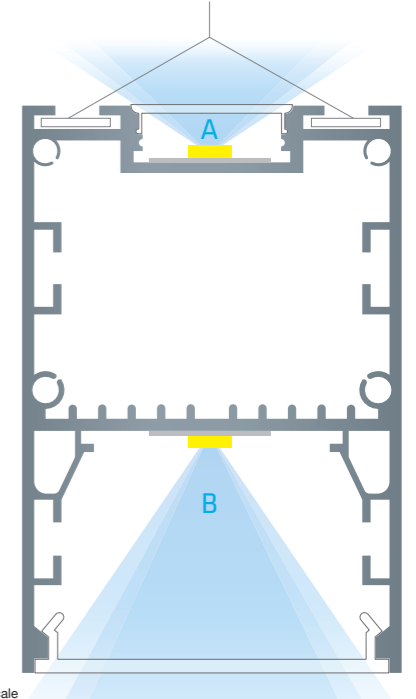
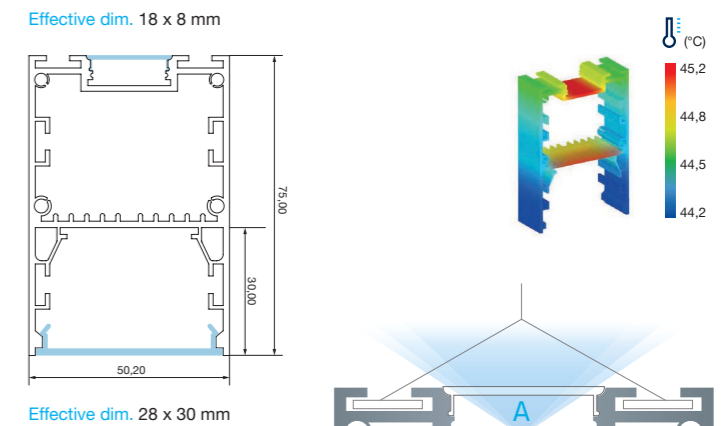

2 m	Custom	max.
PF5074CLAN	PF5074CLCMAN	RAL 9007 38,4 W/m
PF5074CLNE	PF5074CLCMNE	RAL 9005 38,4 W/m
PF5074CLBL	PF5074CLCMBL	RAL 9016 38,4 W/m

Which measure do you need? Contact us!  
 Di che misura hai bisogno? Contattaci!

PRO **LEAN PF5532CL**

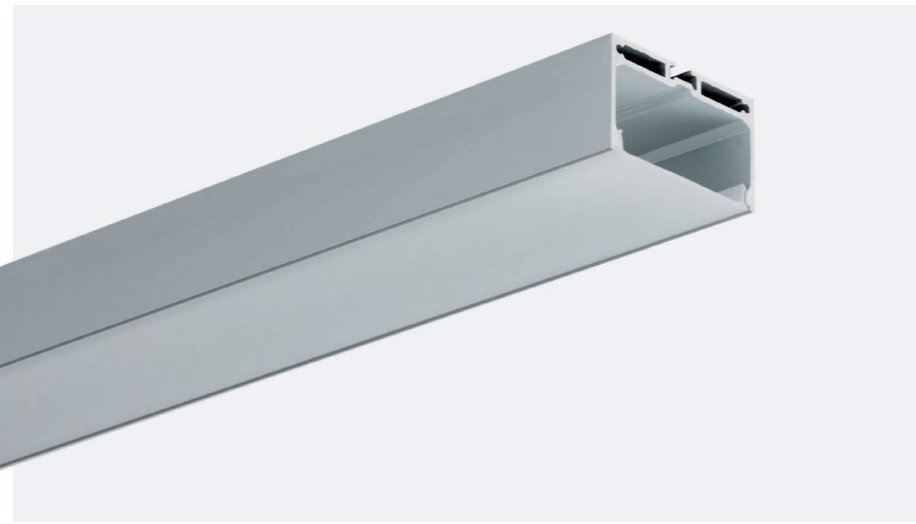

**38,4 W/m**  
Max. Power

**45 mm**  
Max. Width

**23,5 mm**  
Max. Height

Effective dimensions  
Dimensioni utili



Cut to size  
Taglio su misura

Aluminium profile for surface or suspension mounting, 55x32 mm.  
Profilo di alluminio da superficie o sospensione, 55x32 mm.

- AL 6063A BODY
- PC DIFFUSER
- 870 g/m
- IP20
- IK08
- PL RAL9007
- NE RAL9005
- BL RAL9016

• ACCESSORIES INCLUDED

- CAPS / TAPPI
- TAPF5532CL (2 pcs)

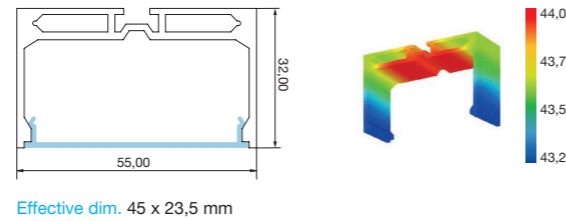

• OPTIONAL ACCESSORIES

- RECESSED / DA INCASSO
- APF5002
- CONNECTION / UNIONE
- APF5005
  - APF5008
  - APF5009
- CLAMP / FISSAGGIO
- APF5007
- SUSPENSION / SOSPENSIONE
- APF5001 (1 m)
  - APF5000 (2 m)
  - APF5013 (3 m)

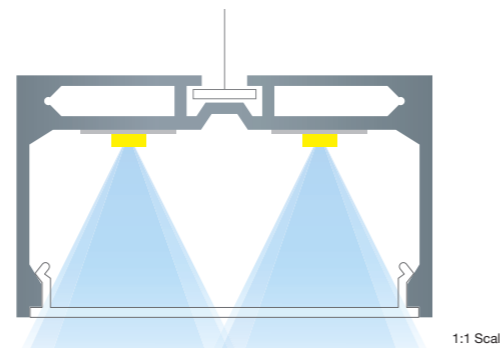

2 m	Custom	max.
PF5532CLAN	PF5532CLCMAN	RAL 9007 38,4 W/m
PF5532CLNE	PF5532CLCMNE	RAL 9005 38,4 W/m
PF5532CLBL	PF5532CLCMBL	RAL 9016 38,4 W/m

Which measure do you need? Contact us!  
Di che misura hai bisogno? Contattaci!



It is possible to realise lineal lighting with suspended profiles, that can be installed on surface too. So, also in this case, the range of possibilities is very widespread.

È possibile realizzare illuminazione lineare con profili sospesi, installabili anche in superficie, pertanto il ventaglio di possibilità è molto ampio, anche in questo caso.

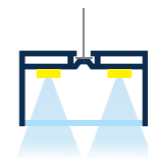

The option to suspend the profile with accessories, such as the steel cable, is particularly nice. It is an interesting choice to install the profile in exhibition spaces and in rooms with irregular ceiling.

L'opzione di sospendere il profilo con degli accessori, come il cavo in acciaio, risulta particolarmente gradevole. È una scelta molto interessante per l'installazione in spazi espositivi e in zone con soffitti irregolari.

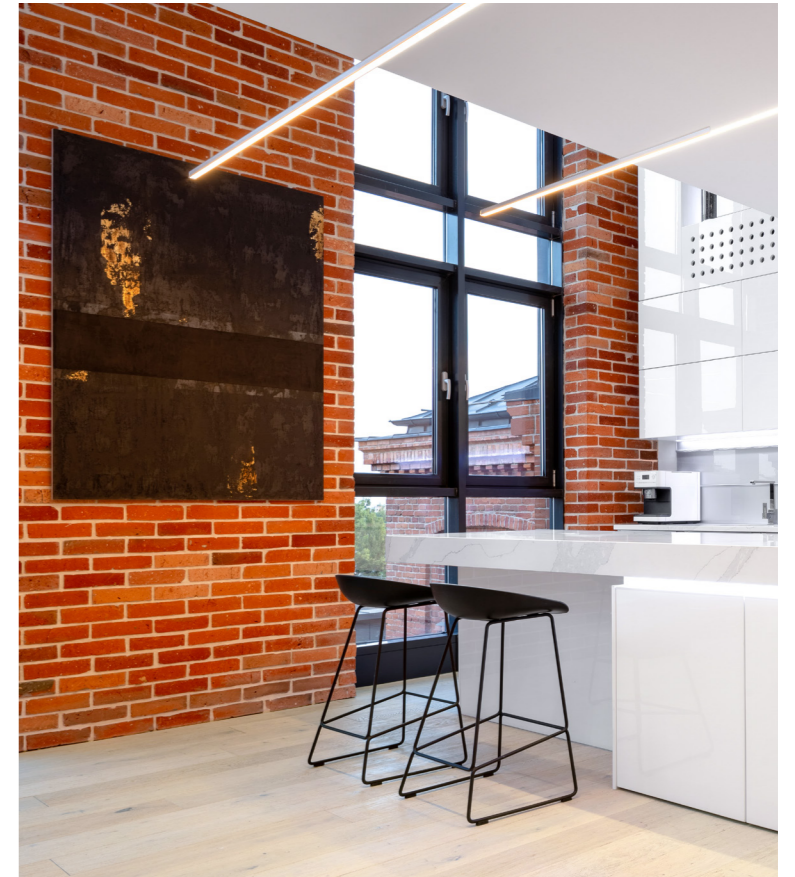

PRO ACRE PF5424AR



⚡ 19,2 W/m Max. Power.  
 12 mm Max. Width  
 13 mm Max. Height  
 Effective dimensions  
 Dimensioni utili



Cut to size  
 Taglio su misura

Aluminium profile for corners, architectural, 54x24 mm.  
 Profilo di alluminio angolare, architettuale, 54x24 mm.

- AL 6063A BODY
- PC DIFFUSER
- 238 g/m
- IP20
- IK08
- PL RAL9007
- NE RAL9005
- BL RAL9016

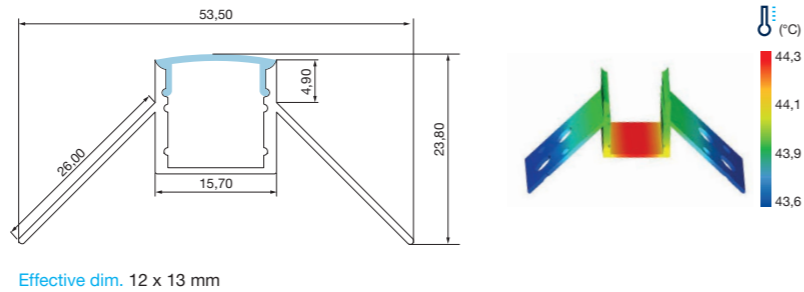

• ACCESSORIES INCLUDED

CAPS / TAPPI



2 m	Custom	max.
PF5424ARAN	PF5424ARCMAN	RAL 9007 19,2 W/m
PF5424ARNE	PF5424ARCMNE	RAL 9005 19,2 W/m
PF5424ARBL	PF5424ARCMBL	RAL 9016 19,2 W/m

Which measure do you need? Contact us!  
 Di che misura hai bisogno? Contattaci!

PRO ACRE PF5815AR

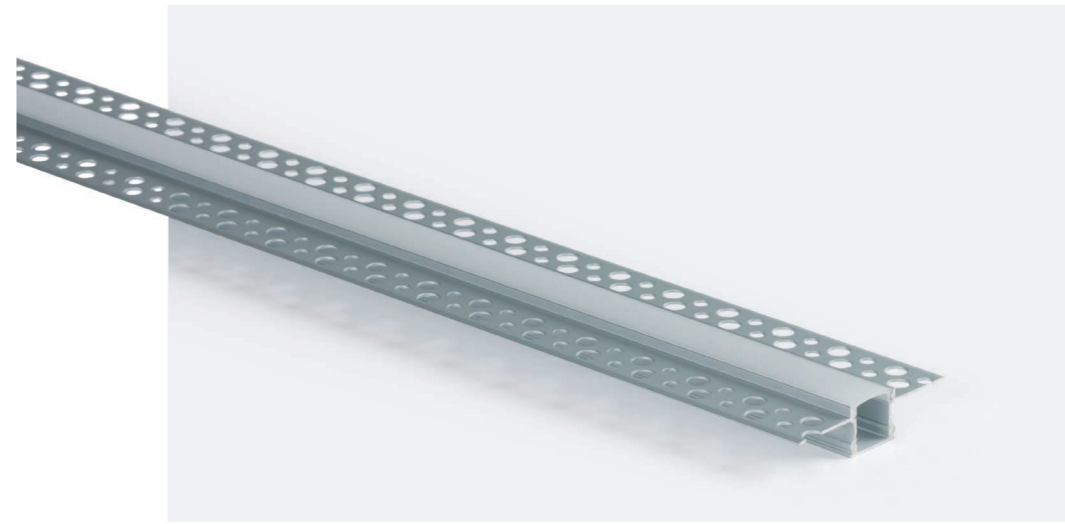

⚡ 19,2 W/m Max. Power.  
 12,5 mm Max. Width  
 13 mm Max. Height  
 Effective dimensions  
 Dimensioni utili



Cut to size  
 Taglio su misura

Aluminium profile for recessed mounting, architectural, 58x15 mm.  
 Profilo di alluminio da incasso, architettuale, 58x15 mm.

- AL 6063A BODY
- PC DIFFUSER
- 232 g/m
- IP20
- IK08
- PL RAL9007
- NE RAL9005
- BL RAL9016

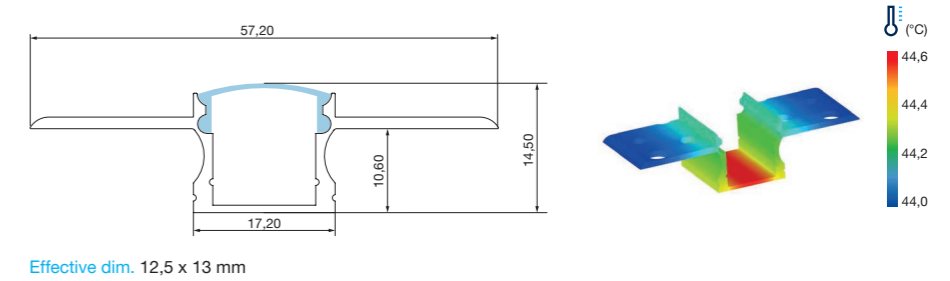

• ACCESSORIES INCLUDED

CAPS / TAPPI

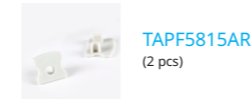

2 m	Custom	max.
PF5815ARAN	PF5815ARCMAN	RAL 9007 19,2 W/m
PF5815ARNE	PF5815ARCMNE	RAL 9005 19,2 W/m
PF5815ARBL	PF5815ARCMBL	RAL 9016 19,2 W/m

Which measure do you need? Contact us!  
 Di che misura hai bisogno? Contattaci!



PRO ACRE PF6320AR

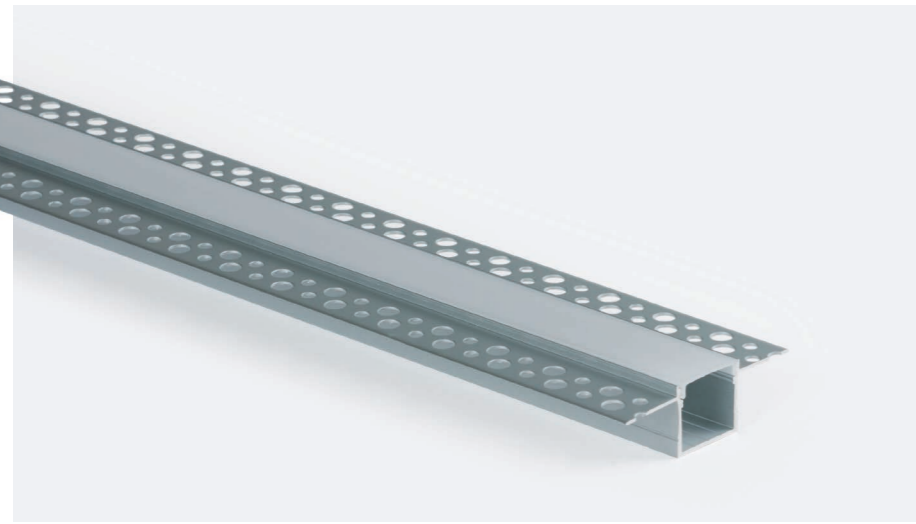

⚡ 19,2 W/m Max. Power  
 📏 20,4 mm Max. Width  
 📏 12,6 mm Max. Height  
 Effective dimensions  
 Dimensioni utili

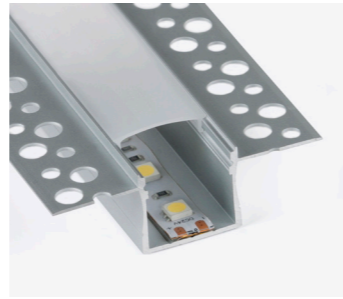

Cut to size  
 Taglio su misura

Aluminium profile for recessed mounting, architectural, 63x20 mm.  
 Profilo di alluminio da incasso, architettuale, 63x20 mm.

- AL 6063A BODY
- PC DIFFUSER
- 296 g/m
- IP20
- IK08
- PL RAL9007
- NE RAL9005
- BL RAL9016

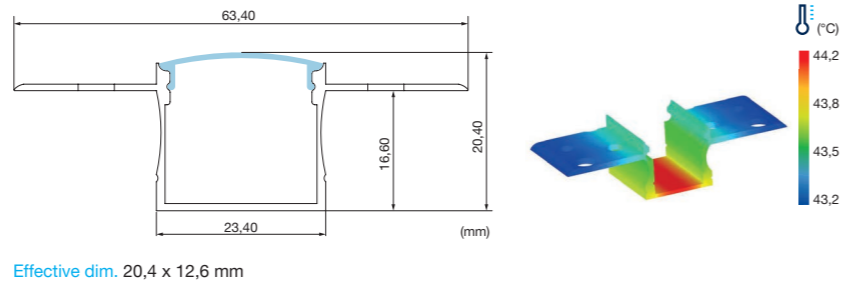

• ACCESSORIES INCLUDED

- CAPS / TAPPI
- TAPF6320AR (2 pcs)

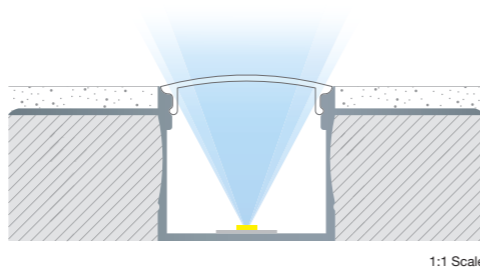

2 m	Custom	max.
PF6320ARAN	PF6320ARCMAN	19,2 W/m
PF6320ARNE	PF6320ARCMNE	19,2 W/m
PF6320ARBL	PF6320ARCMBL	19,2 W/m

Which measure do you need? Contact us!  
 Di che misura hai bisogno? Contattaci!

PRO ACRE PF7435AR

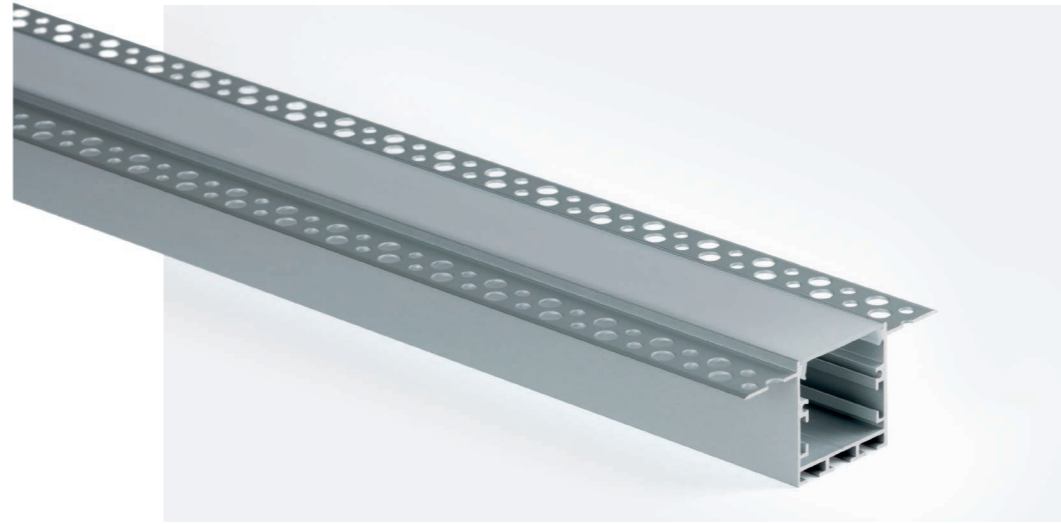

⚡ 38,4 W/m Max. Power  
 📏 26 mm Max. Width  
 📏 28 mm Max. Height  
 Effective dimensions  
 Dimensioni utili

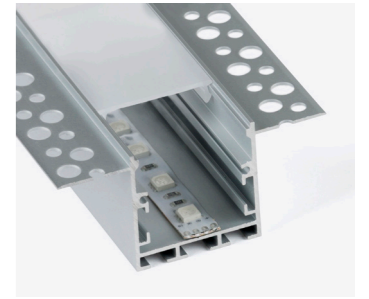

Cut to size  
 Taglio su misura

Aluminium profile for recessed mounting, architectural, 74x35 mm.  
 Profilo di alluminio da incasso, architettuale, 74x35 mm.

- AL 6063A BODY
- PC DIFFUSER
- 616 g/m
- IP20
- IK08
- PL RAL9007
- NE RAL9005
- BL RAL9016

• ACCESSORIES INCLUDED

- CAPS / TAPPI
- TAPF7435AR (2 pcs)

• OPTIONAL ACCESSORIES

- |                       |                     |
|-----------------------|---------------------|
| RECESSED / DA INCASSO | CONNECTION / UNIONE |
| APF5002               | APF5005             |
| CLAMP / FISSAGGIO     |                     |
| APF5003               | APF5008             |
|                       | APF5009             |
| APF5007               |                     |

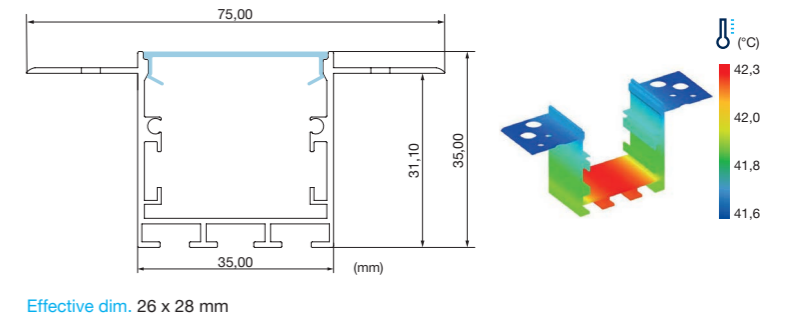

2 m	Custom	max.
PF7435ARAN	PF7435ARCMAN	38,4 W/m
PF7435ARNE	PF7435ARCMNE	38,4 W/m
PF7435ARBL	PF7435ARCMBL	38,4 W/m

Which measure do you need? Contact us!  
 Di che misura hai bisogno? Contattaci!

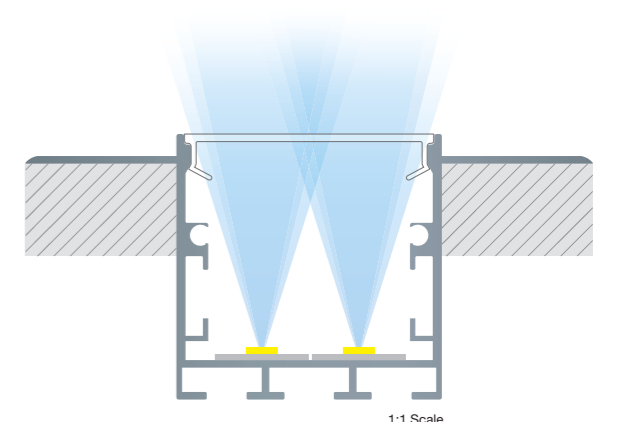

PRO ACRE PF3545AR

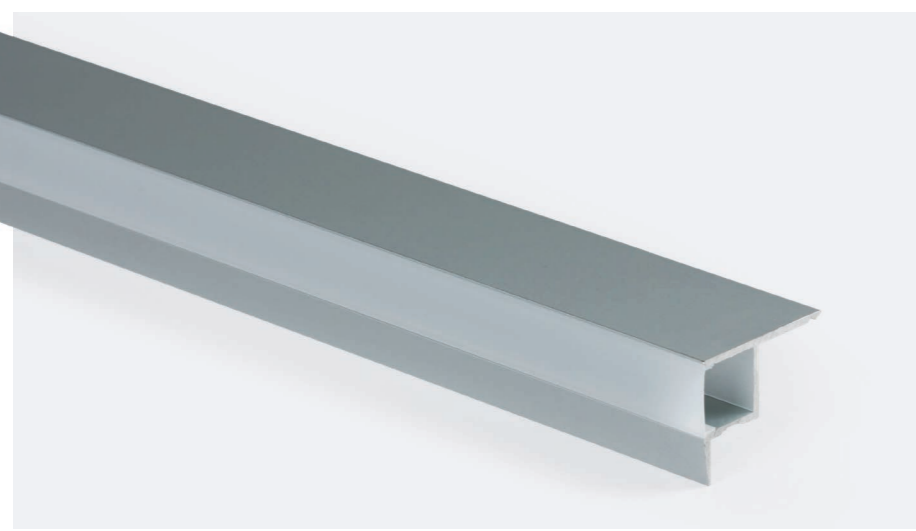

⚡ 19,2 W/m Max. Power  
 18 mm Max. Width  
 14 mm Max. Height  
 Effective dimensions  
 Dimensioni utili



Cut to size  
 Taglio su misura

Aluminium profile for false ceiling, architectural, direct or indirect light, 35x45 mm.  
 Profilo di alluminio per controsoffitto, architettuale, luce diretta o indiretta, 35x45 mm.

- AL 6063A BODY
- PC DIFFUSER
- 476 g/m
- IP20
- IK08
- PL RAL9007
- NE RAL9005
- BL RAL9016

• ACCESSORIES INCLUDED

CAPS / TAPPI

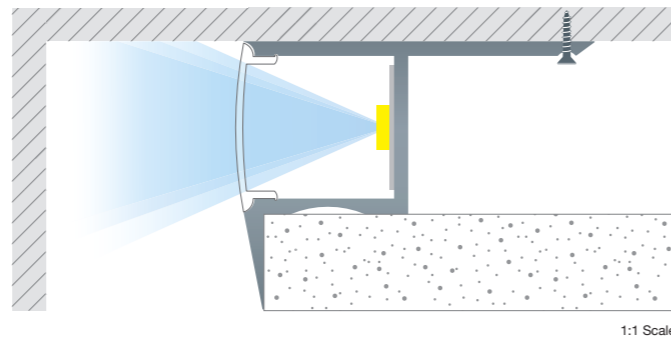
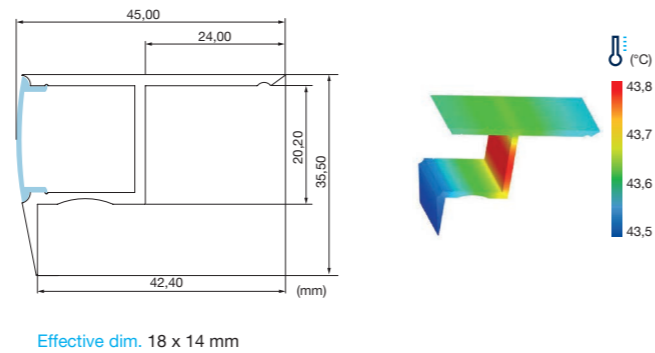

2 m	Custom	max.
PF3545ARAN	PF3545ARCMAN	RAL 9007 19,2 W/m
PF3545ARNE	PF3545ARCMNE	RAL 9005 19,2 W/m
PF3545ARBL	PF3545ARCMBL	RAL 9016 19,2 W/m

Which measure do you need? Contact us!  
 Di che misura hai bisogno? Contattaci!

PRO ACRE PF6214AR

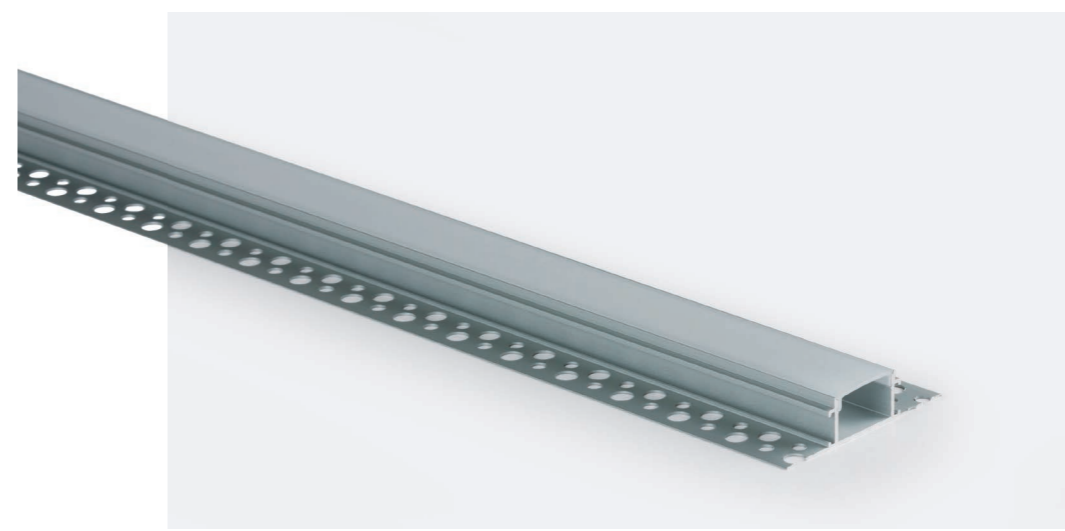

⚡ 19,2 W/m Max. Power  
 18,5 mm Max. Width  
 12 mm Max. Height  
 Effective dimensions  
 Dimensioni utili

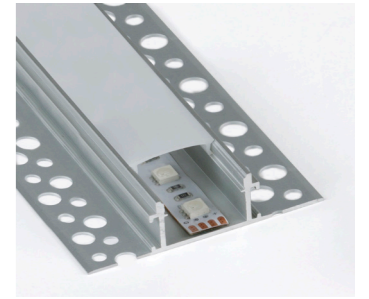

Cut to size  
 Taglio su misura

Aluminium profile for tile or stone wall, architectural, 62x14 mm.  
 Profilo di alluminio per pareti con piastrelle o pietra, architettuale, 62x14 mm.

- AL 6063A BODY
- PC DIFFUSER
- 294 g/m
- IP20
- IK08
- PL RAL9007
- NE RAL9005
- BL RAL9016

• ACCESSORIES INCLUDED

CAPS / TAPPI

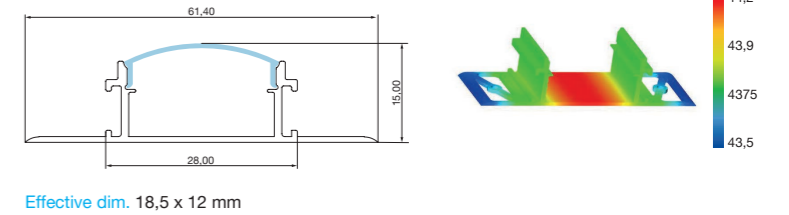

• OPTIONAL ACCESSORIES

CONNECTION / UNIONE



CLAMP / FISSAGGIO

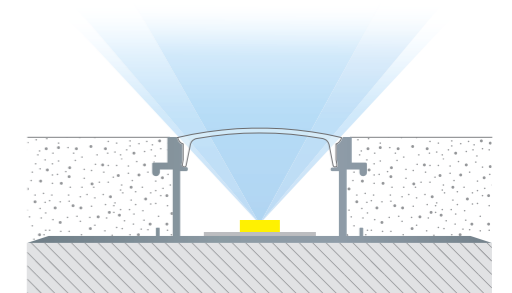

2 m	Custom	max.
PF6214ARAN	PF6214ARCMAN	RAL 9007 19,2 W/m
PF6214ARNE	PF6214ARCMNE	RAL 9005 19,2 W/m
PF6214ARBL	PF6214ARCMBL	RAL 9016 19,2 W/m

Which measure do you need? Contact us!  
 Di che misura hai bisogno? Contattaci!

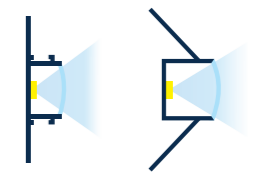

The design of these profiles is faultlessly blended into the architecture of buildings, creating avant-garde shapes with elegant lines and edges. Conceived to be installed on materials such as concrete, they greatly concur to improve the visibility of the outdoor environment.

*Il design di questi profili si armonizza in modo impeccabile con l'architettura degli edifici, creando forme d'avanguardia con linee e contorni eleganti. Progettati per essere installati su materiali come il cemento, contribuiscono in maniera significativa a migliorare la visibilità dell'ambiente all'esterno.*

## PRO KONDA PF1615EQ



**19,2 W/m**  
Max. Power  
**10,5 mm**  
Max. Width  
**8,5 mm**  
Max. Height  
 Effective dimensions  
Dimensioni utili



Cut to size  
Taglio su misura

Aluminium profile for corner surface mounting, 90° opening angle, 16x15 mm.  
 Profilo di alluminio da superficie angolare, angolo di apertura 90°, 16x15 mm.

BODY | DIFFUSER | | | | RAL9007 | RAL9005 | RAL9016

## • ACCESSORIES INCLUDED

## CAPS / TAPPI



**TAPF1615EQ**  
(2 pcs)

## CLIPS / CLIP



**CLPF1615EQ**  
(4 pcs)

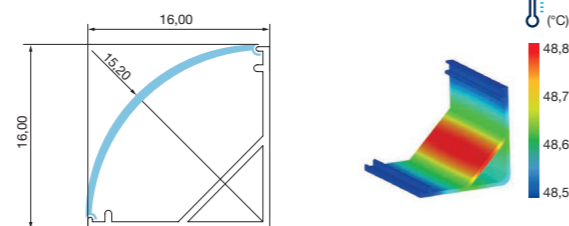

Effective dim. 10,5 x 8,5 mm

## • OPTIONAL ACCESSORIES

## CONNECTION / UNIONE



**APF5014**  
(1 piece)

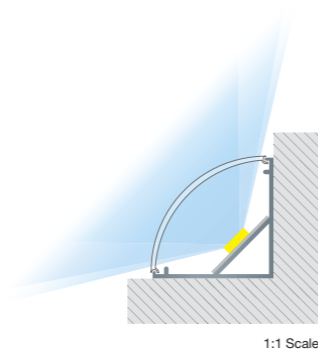

1:1 Scale

2 m	Custom	max.
PF1615EQAN	PF1615EQCMAN	RAL 9007
PF1615EQNE	PF1615EQCMNE	RAL 9005
PF1615EQBL	PF1615EQCMBL	RAL 9016

Which measure do you need? Contact us!  
 Di che misura hai bisogno? Contattaci!

## PRO KONDA PF1818EQ

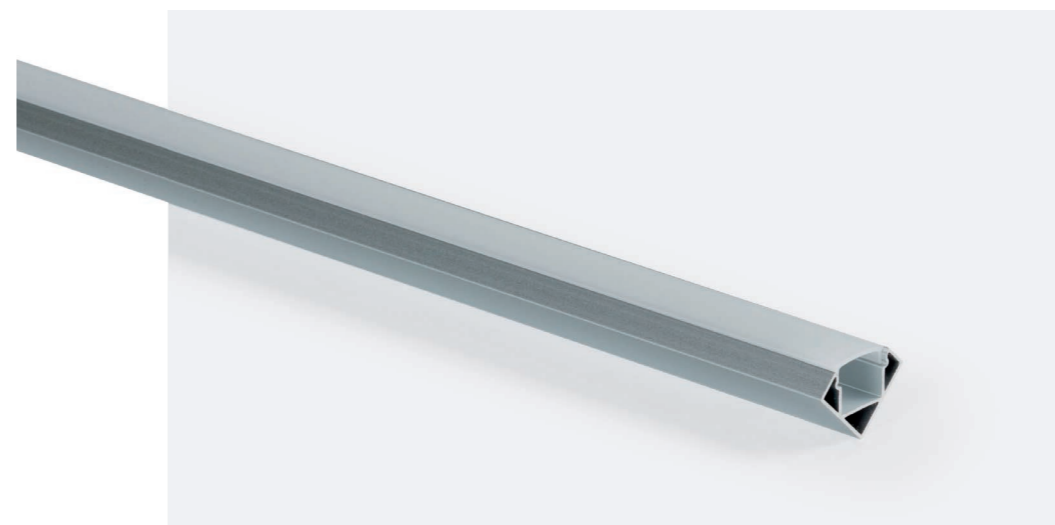

**19,2 W/m**  
Max. Power  
**12,4 mm**  
Max. Width  
**9,7 mm**  
Max. Height  
 Effective dimensions  
Dimensioni utili



Cut to size  
Taglio su misura

Aluminium profile for corner surface mounting, 60° opening angle, 18x18 mm.  
 Profilo di alluminio da superficie angolare, angolo di apertura 60°, 18x18 mm.

BODY | DIFFUSER | | | | RAL9007 | RAL9005 | RAL9016

## • ACCESSORIES INCLUDED

## CAPS / TAPPI



**TAPF1818EQ**  
(2 pcs)

## CLIPS / CLIP



**CLPF1818EQ**  
(4 pcs)

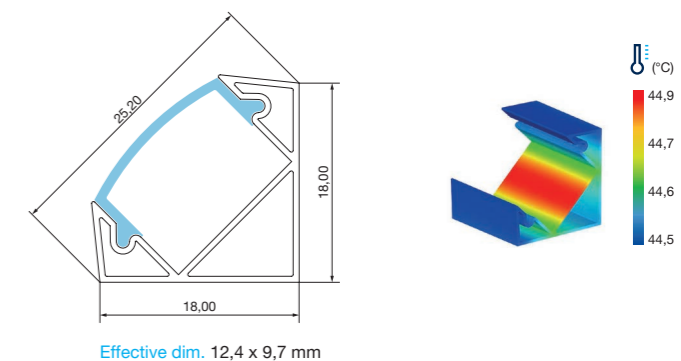

Effective dim. 12,4 x 9,7 mm

## • OPTIONAL ACCESSORIES

## DIFFUSERS / DIFFUSORI



**DFP1122C1M**  
(1 m)

DFP01127VEC1M  
 DFP01124ROC1M  
 DFP01123NEC1M  
 DFP01126AZC1M  
 DFP01125NAC1M  
(1 m)



1:1 Scale

2 m	Custom	max.
PF1818EQAN	PF1818EQCMAN	RAL 9007
PF1818EQNE	PF1818EQCMNE	RAL 9005
PF1818EQBL	PF1818EQCMBL	RAL 9016

Which measure do you need? Contact us!  
 Di che misura hai bisogno? Contattaci!

PRO **KONDA PF0881EQ**



**9,6 W/m**  
Max. Power.

**4 mm**  
Max. Width

**4 mm**  
Max. Height

Effective dimensions  
Dimensioni utili



Aluminium profile for corner surface mounting, extra thin, with curved diffuser, 8x8 mm.  
Profilo di alluminio da superficie angolare, extrasottile, con diffusore curvo 8x8 mm.

Cut to size  
Taglio su misura

- AL 6063A BODY
- PC DIFFUSER
- 100 g/m
- IP20
- IK08
- PL RAL9007
- NE RAL9005
- BL RAL9016

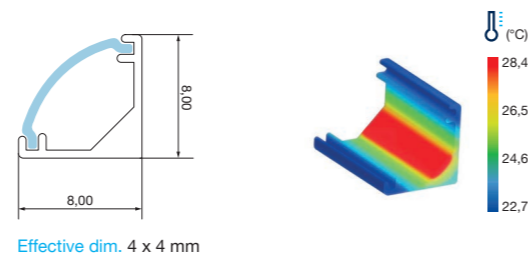

• ACCESSORIES INCLUDED

- CAPS / TAPPI: TAPF0881EQ (2 pcs)
- CLIPS / CLIP: CLPF0881EQ (4 pcs)



2 m	Custom		max.
PF0881EQAN	PF0881EQCMAN	RAL 9007	9,6 W/m
PF0881EQNE	PF0881EQCMNE	RAL 9005	9,6 W/m
PF0881EQBL	PF0881EQCMBL	RAL 9016	9,6 W/m

Which measure do you need? Contact us!  
Di che misura hai bisogno? Contattaci!

PRO **KONDA PF0882EQ**



**9,6 W/m**  
Max. Power.

**4 mm**  
Max. Width

**5,5 mm**  
Max. Height

Effective dimensions  
Dimensioni utili



Aluminium profile for corner surface mounting, extra thin, with square diffuser, 8x8 mm.  
Profilo di alluminio da superficie angolare, extrasottile, con diffusore quadrato 8x8 mm.

Cut to size  
Taglio su misura

- AL 6063A BODY
- PC DIFFUSER
- 90 g/m
- IP20
- IK08
- PL RAL9007
- NE RAL9005
- BL RAL9016

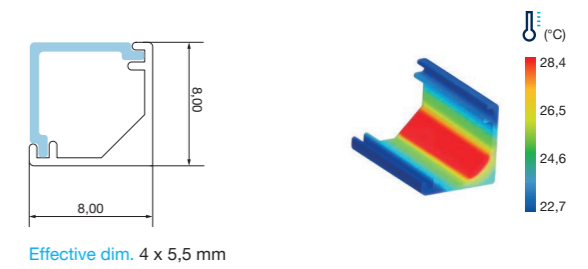

• ACCESSORIES INCLUDED

- CAPS / TAPPI: TAPF0882EQ (2 pcs)
- CLIPS / CLIP: CLPF0882EQ (4 pcs)



2 m	Custom		max.
PF0882EQAN	PF0882EQCMAN	RAL 9007	9,6 W/m
PF0882EQNE	PF0882EQCMNE	RAL 9005	9,6 W/m
PF0882EQBL	PF0882EQCMBL	RAL 9016	9,6 W/m

Which measure do you need? Contact us!  
Di che misura hai bisogno? Contattaci!



Strategically placed on the corner, this profile not only improves the aesthetics of the room but also provides a smooth and welcoming light. Besides meeting the practical requirement of lighting up the living room, it contributes to the creation of a warm and cosy atmosphere.

*Posizionato strategicamente nell'angolo, questo profilo non solo migliora l'estetica della stanza, ma fornisce anche una luce morbida e accogliente. Oltre a rispondere al requisito pratico di illuminare il salone, contribuisce a creare un'atmosfera calda e gradevole.*



Aluminium corner profiles allow LED strips to be installed in spaces like this walk-in wardrobe where the visibility is optimised while the aesthetics is improved, making corners well-lighted and eye-catcher zones.

*I profili angolari in alluminio rendono possibile installare le strip LED in spazi come questa cabina armadio dove non solo si ottimizza la visibilità ma si migliora l'estetica, rendendo gli angoli zone ben illuminate e che attraggono lo sguardo.*

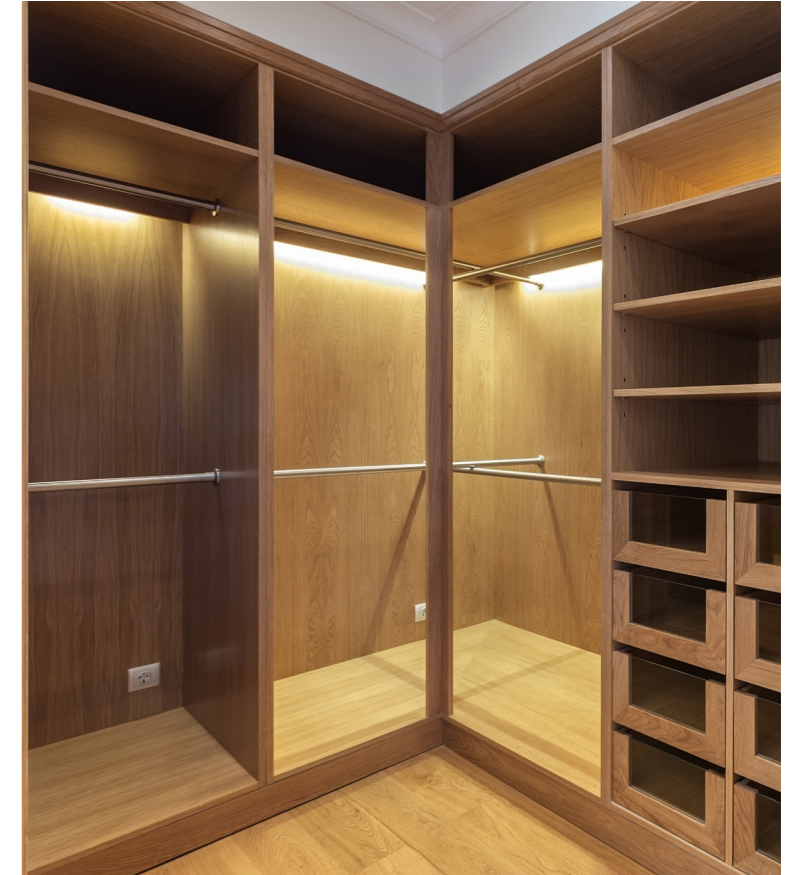

The extra thin corner profile, specifically conceived for our special narrow LED strip, thanks to its slim and discreet design, provides a sober and pleasant lighting to the showcase of this kitchen.

*Il profilo angolare extrasottile, progettato specificatamente per la nostra strip LED speciale stretta, grazie al suo design sottile e discreto, fornisce un'illuminazione sobria e piacevole alla vetrinetta di questa cucina.*



PRO RENO PF6826EL

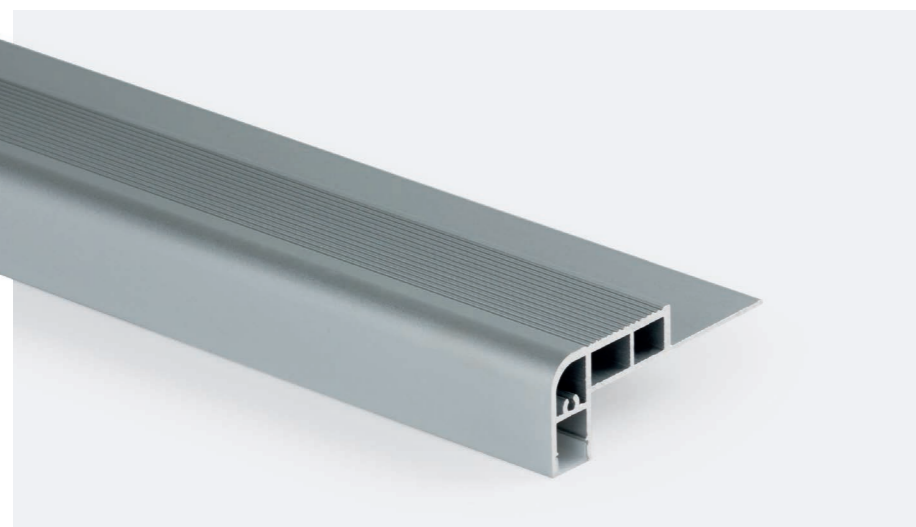

⚡ 14,4 W/m Max. Power.  
 📏 9,5 mm Max. Width  
 📏 6,6 mm Max. Height  
 Effective dimensions  
 Dimensioni utili



✂️ Cut to size  
 Taglio su misura

Aluminium profile for staircases, bottom lighting, 68x26 mm.  
 Profilo di alluminio per scala, illuminazione inferiore, 68x26 mm.

- AL 6063A BODY
- PC DIFFUSER
- 656 g/m
- IP20
- IK08
- PL RAL9007
- NE RAL9005
- BL RAL9016

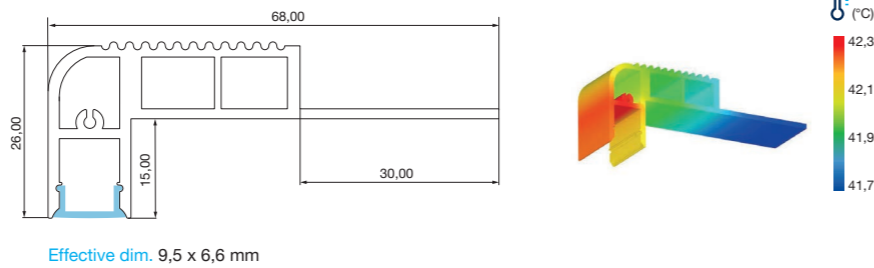

• ACCESSORIES INCLUDED

CAPS / TAPPI

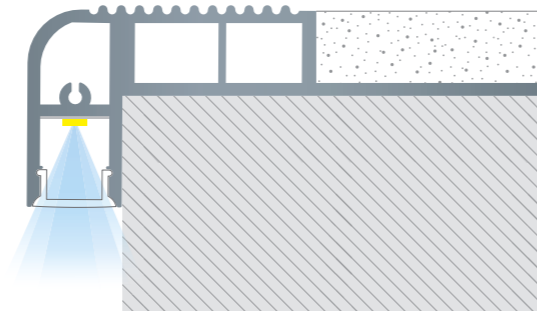

1:1 Scale

2 m	Custom	✂️	⚡ max.
PF6826ELAN	PF6826ELCMAN	■ RAL 9007	14,4 W/m
PF6826ELNE	PF6826ELCMNE	■ RAL 9005	14,4 W/m
PF6826ELBL	PF6826ELCMBL	□ RAL 9016	14,4 W/m

Which measure do you need? Contact us!  
 Di che misura hai bisogno? Contattaci!

PRO RENO PF6628EL



⚡ 19,2 W/m Max. Power.  
 📏 12,4 mm Max. Width  
 📏 11 mm Max. Height  
 Effective dimensions  
 Dimensioni utili



✂️ Cut to size  
 Taglio su misura

Aluminium profile for staircases, top lighting, 66x28 mm.  
 Profilo di alluminio per scala, illuminazione superiore, 66x28 mm.

- AL 6063A BODY
- PC DIFFUSER
- 632 g/m
- IP20
- IK08
- PL RAL9007
- NE RAL9005
- BL RAL9016

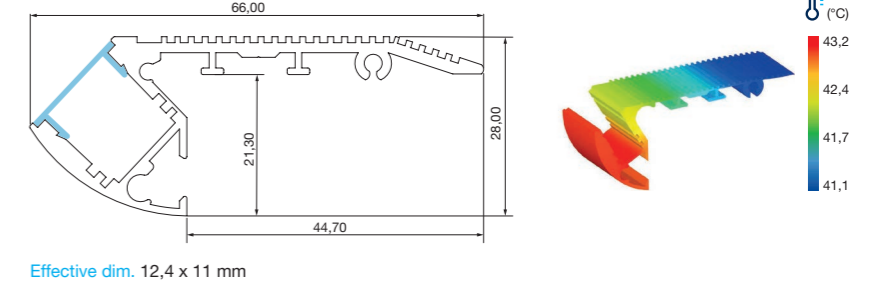

• ACCESSORIES INCLUDED

CAPS / TAPPI

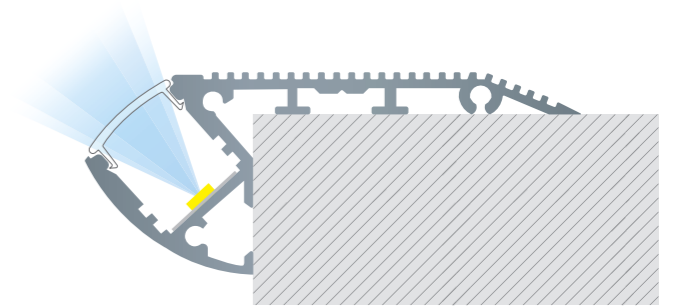

1:1 Scale

2 m	Custom	✂️	⚡ max.
PF6628ELAN	PF6628ELCMAN	■ RAL 9007	19,2 W/m
PF6628ELNE	PF6628ELCMNE	■ RAL 9005	19,2 W/m
PF6628ELBL	PF6628ELCMBL	□ RAL 9016	19,2 W/m

Which measure do you need? Contact us!  
 Di che misura hai bisogno? Contattaci!

PRO SELE PF2711SL



⚡ 19,2 W/m Max. Power.  
 12,2 mm Max. Width  
 6,7 mm Max. Height  
 Effective dimensions  
 Dimensioni utili



Aluminium profile for recessed mounting in floor, with flaps, 27x11 mm.  
 Profilo di alluminio da incasso per pavimenti, con alette, 27x11 mm.

Cut to size  
 Taglio su misura

- AL 6063A BODY
- PC DIFFUSER
- 262 g/m
- IP20
- IK08
- PL RAL9007
- NE RAL9005
- BL RAL9016

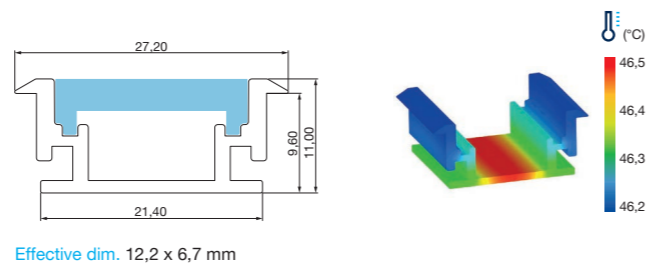

• ACCESSORIES INCLUDED

CAPS / TAPPI

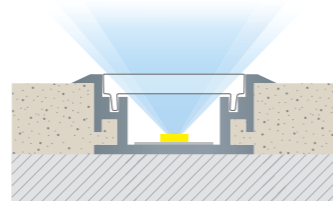

1:1 Scale

2 m	Custom	max.
PF2711SLAN	PF2711SLCMAN	RAL 9007 19,2 W/m
PF2711SLNE	PF2711SLCMNE	RAL 9005 19,2 W/m
PF2711SLBL	PF2711SLCMBL	RAL 9016 19,2 W/m

Which measure do you need? Contact us!  
 Di che misura hai bisogno? Contattaci!

PRO SELE PF1609SL

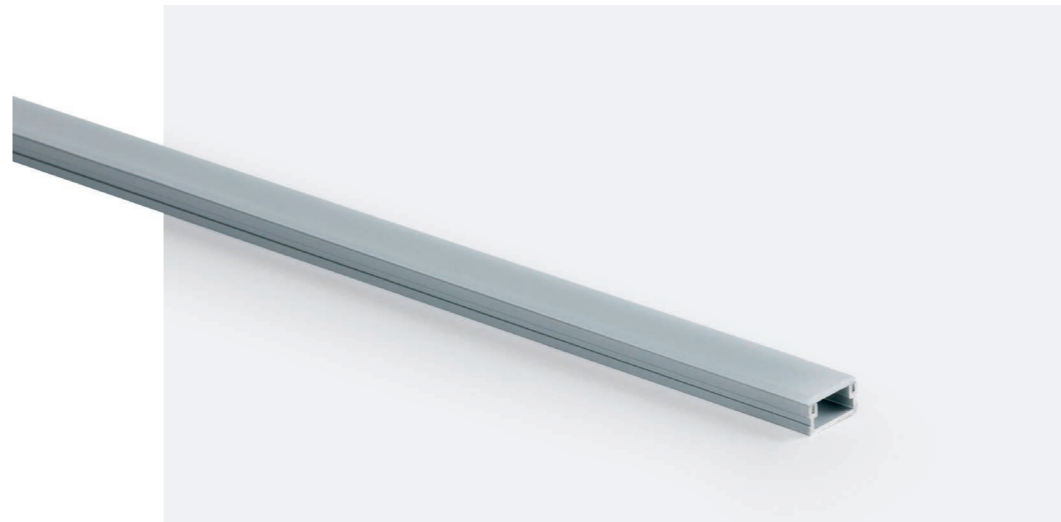

⚡ 19,2 W/m Max. Power.  
 10,5 mm Max. Width  
 5,8 mm Max. Height  
 Effective dimensions  
 Dimensioni utili



Aluminium profile for recessed mounting in floor, without flaps, 16x9 mm.  
 Profilo di alluminio da incasso per pavimenti, senza alette, 16x9 mm.

Cut to size  
 Taglio su misura

- AL 6063A BODY
- PC DIFFUSER
- 132 g/m
- IP20
- IK08
- PL RAL9007
- NE RAL9005
- BL RAL9016

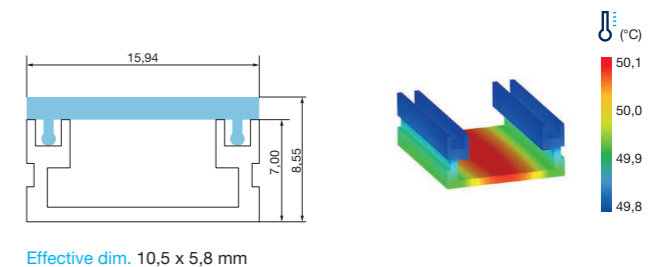

• ACCESSORIES INCLUDED

CAPS / TAPPI

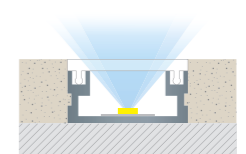

1:1 Scale

2 m	Custom	max.
PF1609SLAN	PF1609SLCMAN	RAL 9007 19,2 W/m
PF1609SLNE	PF1609SLCMNE	RAL 9005 19,2 W/m
PF1609SLBL	PF1609SLCMBL	RAL 9016 19,2 W/m

Which measure do you need? Contact us!  
 Di che misura hai bisogno? Contattaci!



PRO SELE PF1613SL



⚡ 19,2 W/m Max. Power.  
 📏 10,5 mm Max. Width  
 📏 9,2 mm Max. Height  
 Effective dimensions  
 Dimensioni utili



Aluminium profile for recessed mounting in floor, without flaps, 16x13 mm.  
 Profilo di alluminio da incasso per pavimenti, senza alette, 16x13 mm.

Cut to size  
 Taglio su misura

- AL 6063A BODY
- PC DIFFUSER
- 150 g/m
- IP20
- IK08
- PL RAL9007
- NE RAL9005
- BL RAL9016

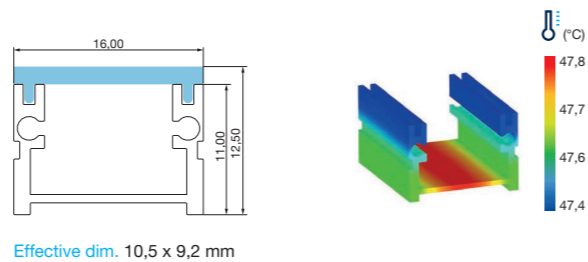

• ACCESSORIES INCLUDED

CAPS / TAPPI

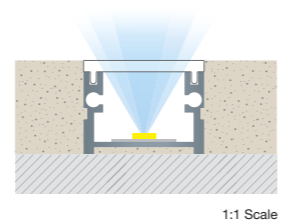

2 m	Custom	IK08	max.
PF1613SLAN	PF1613SLCMAN	RAL 9007	19,2 W/m
PF1613SLNE	PF1613SLCMNE	RAL 9005	19,2 W/m
PF1613SLBL	PF1613SLCMBL	RAL 9016	19,2 W/m

Which measure do you need? Contact us!  
 Di che misura hai bisogno? Contattaci!

PRO SELE PF2226SL



⚡ 19,2 W/m Max. Power.  
 📏 12,5 mm Max. Width  
 📏 21,3 mm Max. Height  
 Effective dimensions  
 Dimensioni utili



Aluminium profile for recessed mounting in floor, visible profile edge, 22x26 mm.  
 Profilo di alluminio da incasso per pavimenti, spigolo del profilo a vista, 22x26 mm.

Cut to size  
 Taglio su misura

- AL 6063A BODY
- PC DIFFUSER
- 412 g/m
- IP20
- IK08
- PL RAL9007
- NE RAL9005
- BL RAL9016

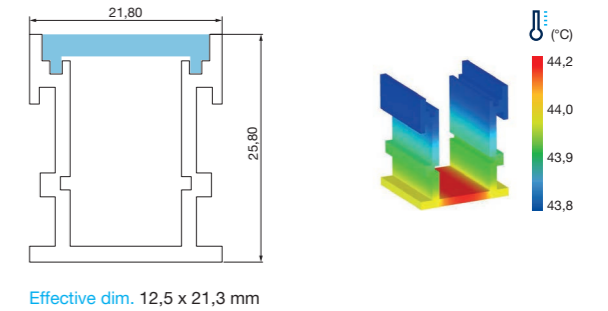

• ACCESSORIES INCLUDED

CAPS / TAPPI

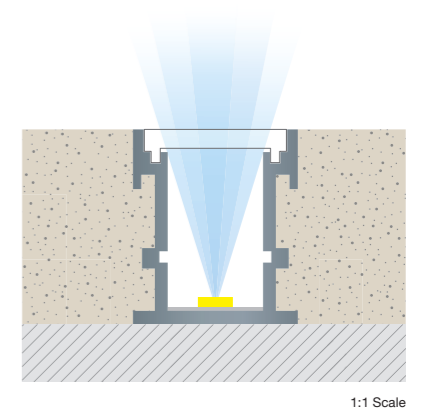
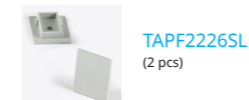

2 m	Custom	IK08	max.
PF2226SLAN	PF2226SLCMAN	RAL 9007	19,2 W/m
PF2226SLNE	PF2226SLCMNE	RAL 9005	19,2 W/m
PF2226SLBL	PF2226SLCMBL	RAL 9016	19,2 W/m

Which measure do you need? Contact us!  
 Di che misura hai bisogno? Contattaci!

PRO EBRO PF4213PD



⚡ 19,2 W/m Max. Power  
 📏 12,5 mm Max. Width  
 📏 5,7 mm Max. Height  
 Effective dimensions  
 Dimensioni utili



Aluminium profile for surface mounting in wall, indirect lighting, 1 LED strip, 42x13 mm.  
 Profilo di alluminio da superficie a parete, illuminazione indiretta, 1 strip LED, 42x13 mm.

Cut to size  
 Taglio su misura

- AL 6063A BODY
- PC DIFFUSER
- 264 g/m
- IP20
- IK08
- PL RAL9007
- NE RAL9005
- BL RAL9016

• ACCESSORIES INCLUDED

- CAPS / TAPPI
- TAPF4213PD (2 pcs)
- CLIPS / CLIP
- CLPF4213PD (4 pcs)

• OPTIONAL ACCESSORIES

- DIFFUSERS / DIFFUSORI
- DFP1122C1M (1 m)
  - DFP01127VEC1M
  - DFP01124ROC1M
  - DFP01123NEC1M
  - DFP01126AZC1M
  - DFP01125NAC1M (1 m)

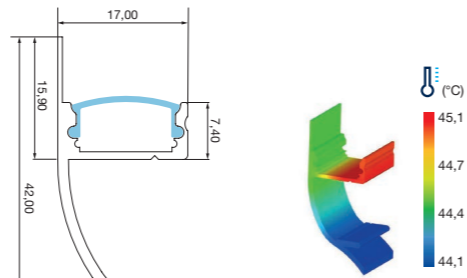

Effective dim. 12,5 x 5,7 mm

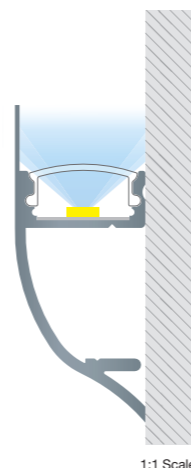

2 m	Custom	max.
PF4213PDAN	PF4213PDCMAN	19,2 W/m
PF4213PDNE	PF4213PDCMNE	19,2 W/m
PF4213PDBL	PF4213PDCMBL	19,2 W/m

Which measure do you need? Contact us!  
 Di che misura hai bisogno? Contattaci!

PRO EBRO PF4913PD



⚡ 38,4 W/m Max. Power  
 📏 12 mm Max. Width  
 📏 6,5 mm Max. Height  
 Effective dimensions  
 Dimensioni utili



Aluminium profile for surface mounting in wall, indirect lighting, 2 LED strips, 49x13 mm.  
 Profilo di alluminio da superficie a parete, illuminazione indiretta, 2 strip LED, 49x13 mm.

Cut to size  
 Taglio su misura

- AL 6063A BODY
- PC DIFFUSER
- 326 g/m
- IP20
- IK08
- PL RAL9007
- NE RAL9005
- BL RAL9016

• ACCESSORIES INCLUDED

- CAPS / TAPPI
- TAPF4913PD (2 pcs)
- CLIPS / CLIP
- CLPF4913PD (4 pcs)

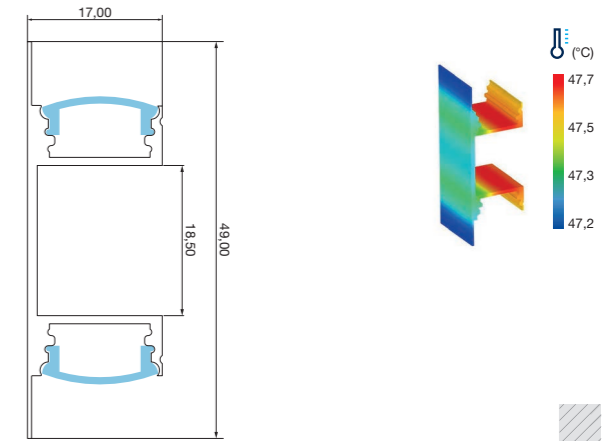

Effective dim. 12 x 6,5 mm

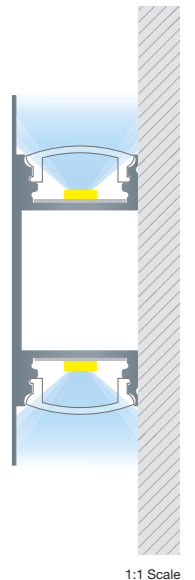

2 m	Custom	max.
PF4913PDAN	PF4913PDCMAN	38,4 W/m
PF4913PDNE	PF4913PDCMNE	38,4 W/m
PF4913PDBL	PF4913PDCMBL	38,4 W/m

Which measure do you need? Contact us!  
 Di che misura hai bisogno? Contattaci!

PRO EBRO PF7060PD



⚡ 19,2 W/m Max. Power.  
 12 mm Max. Width  
 6,5 mm Max. Height  
 Effective dimensions  
 Dimensioni utili



Cut to size  
 Taglio su misura

Aluminium profile for recessed mounting on wall, indirect lighting, 1 LED strip, 75x25 mm.  
 Profilo di alluminio da incasso a parete, illuminazione indiretta, 1 strip LED, 75x25 mm.

AL 6063A BODY | PC DIFFUSER | 718 g/m | IP20 | IK08 | PL RAL9007 | NE RAL9005 | BL RAL9016

• ACCESSORIES INCLUDED

CAPS / TAPPI



• OPTIONAL ACCESSORIES

CONNECTION / UNIONE



CLAMP / FISSAGGIO

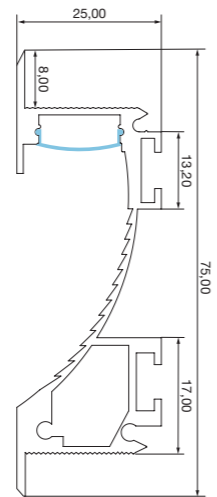

Effective dim. 12 x 6,5 mm

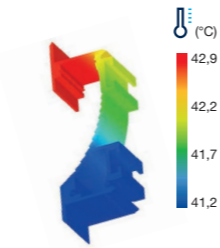

2 m	Custom	max.
PF7060PDAN	PF7060PDCMAN	19,2 W/m
PF7060PDNE	PF7060PDCMNE	19,2 W/m
PF7060PDBL	PF7060PDCMBL	19,2 W/m

Which measure do you need? Contact us!  
 Di che misura hai bisogno? Contattaci!

1:1 Scale

PRO EBRO PF4084PD

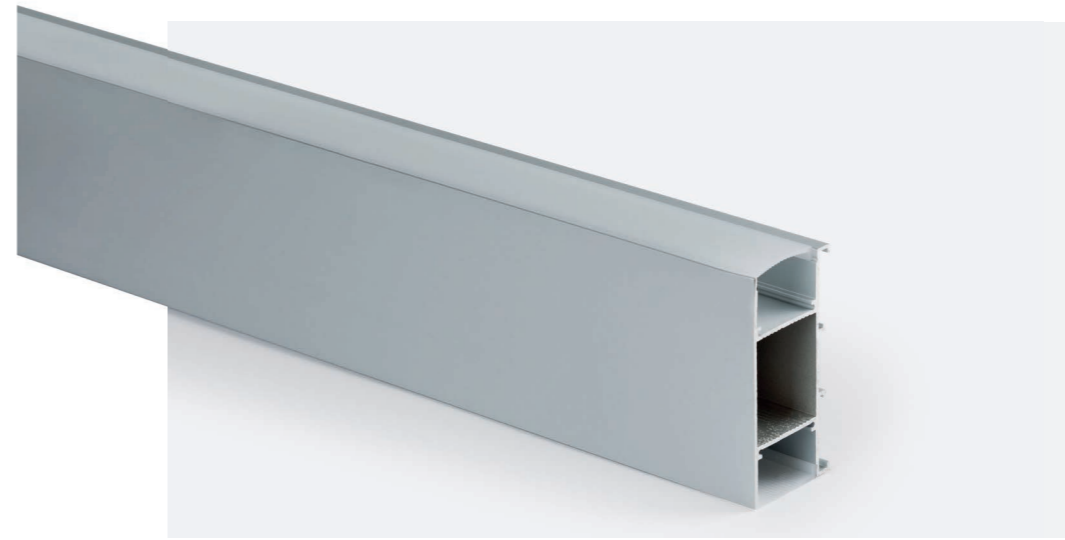

⚡ 38,4 W/m Max. Power.  
 27,2 mm Max. Width  
 20 mm Max. Height  
 Effective dimensions  
 Dimensioni utili



Cut to size  
 Taglio su misura

Aluminium profile for surface mounting on wall, indirect lighting, 2 LED strips, 40x84 mm.  
 Profilo di alluminio da superficie a parete, illuminazione indiretta, 2 strip LED, 40x84 mm.

AL 6063A BODY | PC DIFFUSER | 1216 g/m | IP20 | IK08 | PL RAL9007 | NE RAL9005 | BL RAL9016

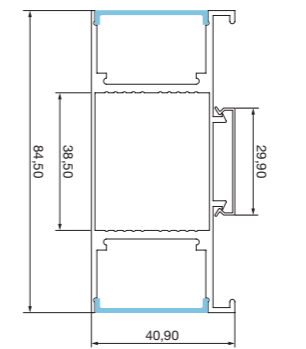

Effective dim. 27,2 x 20 mm

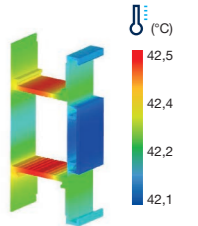

• ACCESSORIES INCLUDED

CAPS / TAPPI



2 m	Custom	max.
PF4084PDAN	PF4084PDCMAN	38,4 W/m
PF4084PDNE	PF4084PDCMNE	38,4 W/m
PF4084PDBL	PF4084PDCMBL	38,4 W/m

Which measure do you need? Contact us!  
 Di che misura hai bisogno? Contattaci!

1:1 Scale

## PRO OKOA PF0430TB



 **19,2 W/m**  
Max. Power.
  **20 mm**  
Max. Width
  **16,5 mm**  
Max. Height

Effective dimensions  
Dimensioni utili



Aluminium profile for suspension mounting, with circular diffuser, 30 mm diameter.  
Profilo di alluminio da sospensione, con diffusore circolare, 30 mm di diametro.

Cut to size  
Taglio su misura 

AL  
6063A

BODY

PC

DIFFUSER

238 g/m

IP20

IK08

PL

RAL9007

NE

RAL9005

BL

RAL9016

## • ACCESSORIES INCLUDED

## CAPS / TAPPI



TAPF0430TB  
(2 pcs)

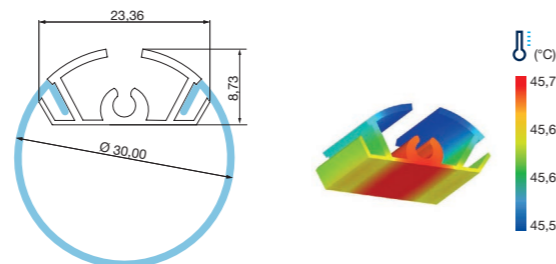

Effective dim. 20 x 16,5 mm

## • OPTIONAL ACCESSORIES

## CONNECTION / UNIONE



APF5005



APF5008



APF5009

## CLAMP / FISSAGGIO



APF5007

## SUSPENSION / SOSPENSIONE



APF5001 (1 m)

APF5000 (2 m)

APF5013 (3 m)

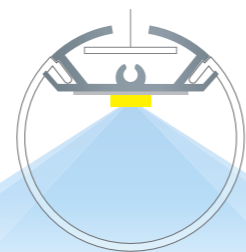

1:1 Scale

2 m	Custom	max.	
PF0430TBAN	PF0430TCMAN	RAL 9007	19,2 W/m
PF0430TBNE	PF0430TCMNE	RAL 9005	19,2 W/m
PF0430TBBL	PF0430TCMBL	RAL 9016	19,2 W/m

Which measure do you need? Contact us!  
Di che misura hai bisogno? Contattaci!



This tube-shaped profile, designed to be installed suspended, represents a unique and modern solution thanks to its cylindrical diffuser, suitable for spaces that need a practical and decorative lighting at the same time.

Questo profilo tubolare, progettato per essere installato in sospensione, rappresenta una soluzione unica e moderna grazie al suo diffusore cilindrico, indicato per spazi che hanno bisogno di un'illuminazione pratica e decorativa al tempo stesso.

PRO GANGES PF8016RD



⚡ 14,4 W/m Max. Power.  
 8 mm Max. Width  
 7 mm Max. Height  
 Effective dimensions  
 Dimensioni utili



Cut to size  
 Taglio su misura

Aluminium profile, skirting board, 80x16 mm.  
 Profilo di alluminio, battiscopa, 80x16 mm.

- AL 5063A BODY
- PC DIFFUSER
- 1016 g/m
- IP20
- IK08
- PL RAL9007
- NE RAL9005
- BL RAL9016

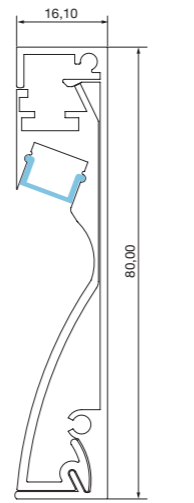

Effective dim. 8 x 7 mm

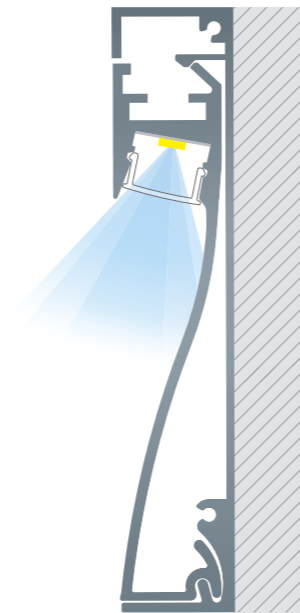
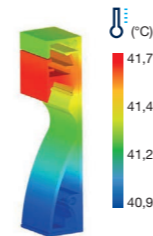

1:1 Scale

• ACCESSORIES INCLUDED

CAPS / TAPPI



2 m	Custom		max.
PF8016RDAN	PF8016RDCMAN	■ RAL 9007	14,4 W/m
PF8016RDNE	PF8016RDCMNE	■ RAL 9005	14,4 W/m
PF8016RDBL	PF8016RDCMBL	□ RAL 9016	14,4 W/m

Which measure do you need? Contact us!  
 Di che misura hai bisogno? Contattaci!

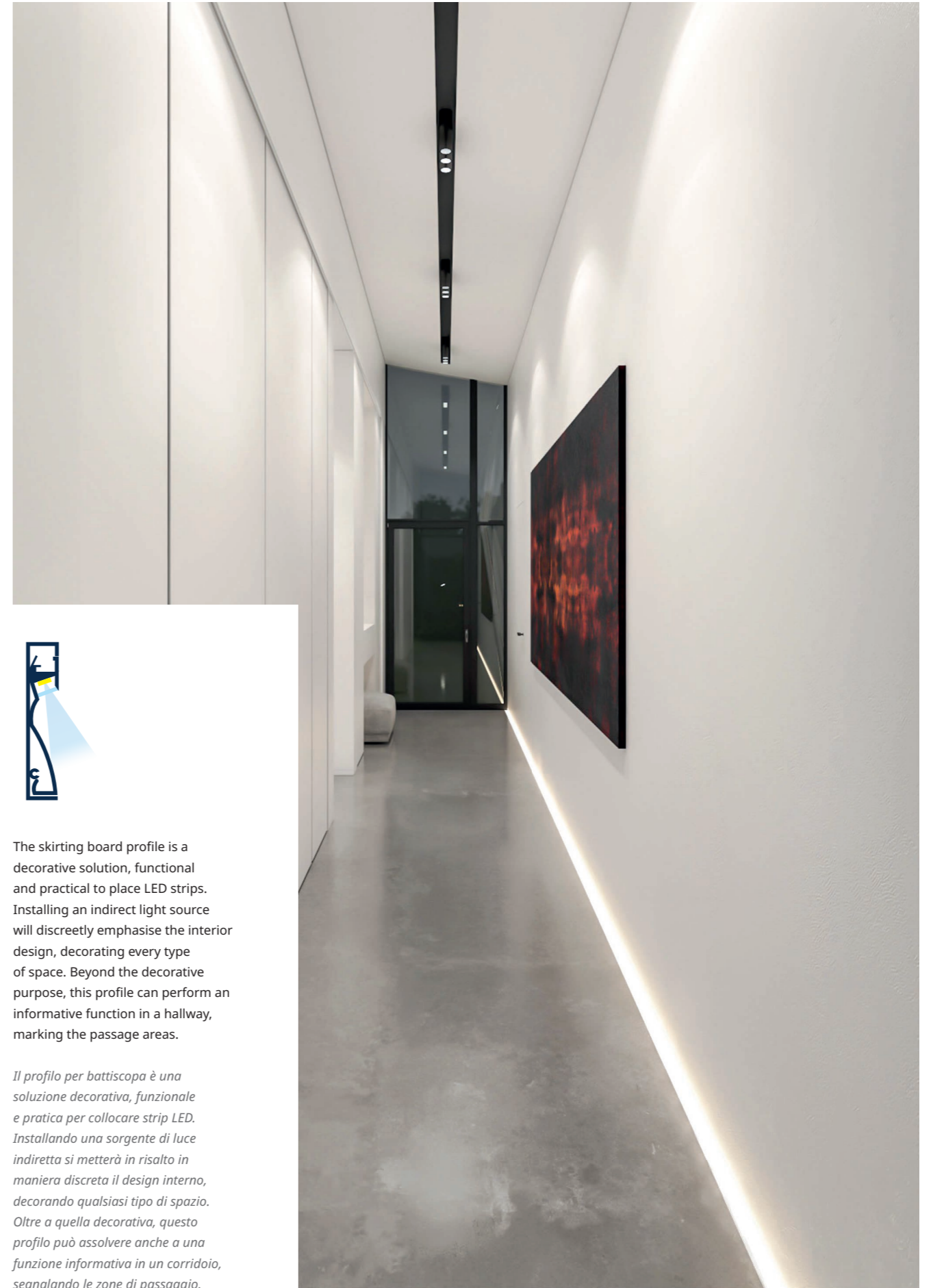

The skirting board profile is a decorative solution, functional and practical to place LED strips. Installing an indirect light source will discreetly emphasise the interior design, decorating every type of space. Beyond the decorative purpose, this profile can perform an informative function in a hallway, marking the passage areas.

*Il profilo per battiscopa è una soluzione decorativa, funzionale e pratica per collocare strip LED. Installando una sorgente di luce indiretta si metterà in risalto in maniera discreta il design interno, decorando qualsiasi tipo di spazio. Oltre a quella decorativa, questo profilo può assolvere anche a una funzione informativa in un corridoio, segnalando le zone di passaggio.*

## PRO DAO PF1503CH

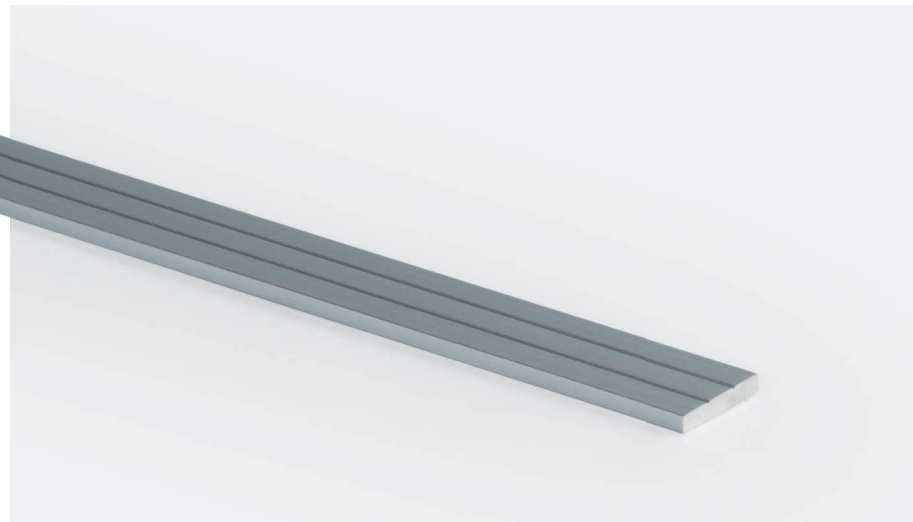

**19,2 W/m**  
Max. Power.

**15 mm**  
Max. Width

Effective dimensions  
Dimensioni utili



Cut to size  
Taglio su misura

Aluminium heat sink plate, 15x2.5 mm.  
Piastra di dissipazione di alluminio, 15x2,5 mm.

AL  
5063A  
BODY

100 g/m

IP20

IK08

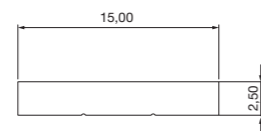
PL  
RAL9007

Max Width: 15 mm

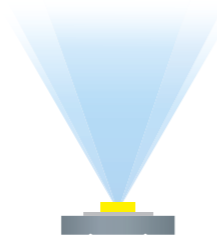
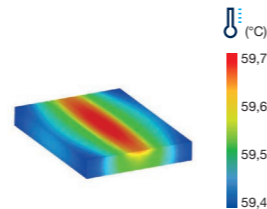

1:1 Scale

2 m Custom max.  
PF1503CHAN PF1503CHCMAN RAL 9007 19,2 W/m

Which measure do you need? Contact us!  
Di che misura hai bisogno? Contattaci!

## PRO DAO PF1508CH

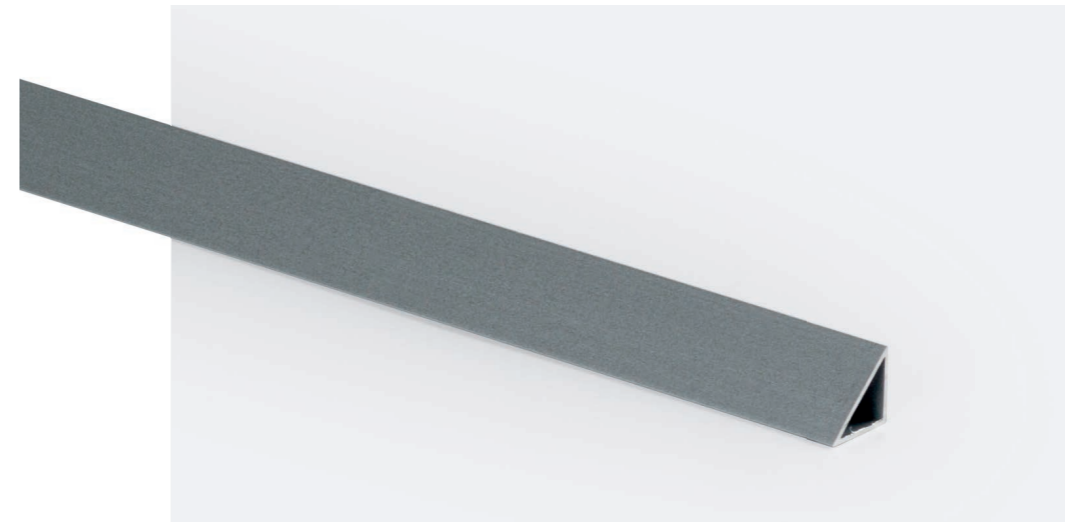

**19,2 W/m**  
Max. Power.

**14,6 mm**  
Max. Width

Effective dimensions  
Dimensioni utili

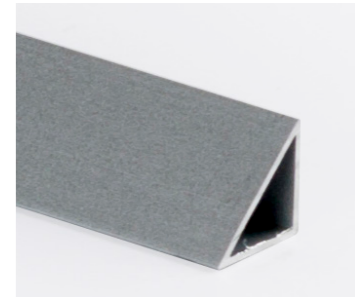

Cut to size  
Taglio su misura

Aluminium heat sink plate for corners, 14.6 mm, depth 7.52 mm.  
Piastra di dissipazione di alluminio angolare, 14,6mm, profondità 7,52 mm.

AL  
5063A  
BODY

50 g/m

IP20

IK08

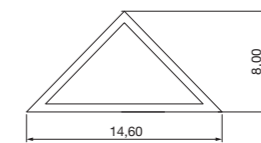
PL  
RAL9007

Max Width: 14,6 mm

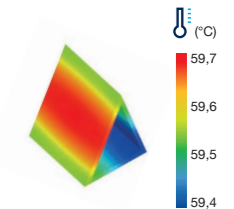

1:1 Scale

2 m Custom max.  
PF1508CHAN PF1508CHCMAN RAL 9007 19,2 W/m

Which measure do you need? Contact us!  
Di che misura hai bisogno? Contattaci!

## PRO DAO PF1515CH

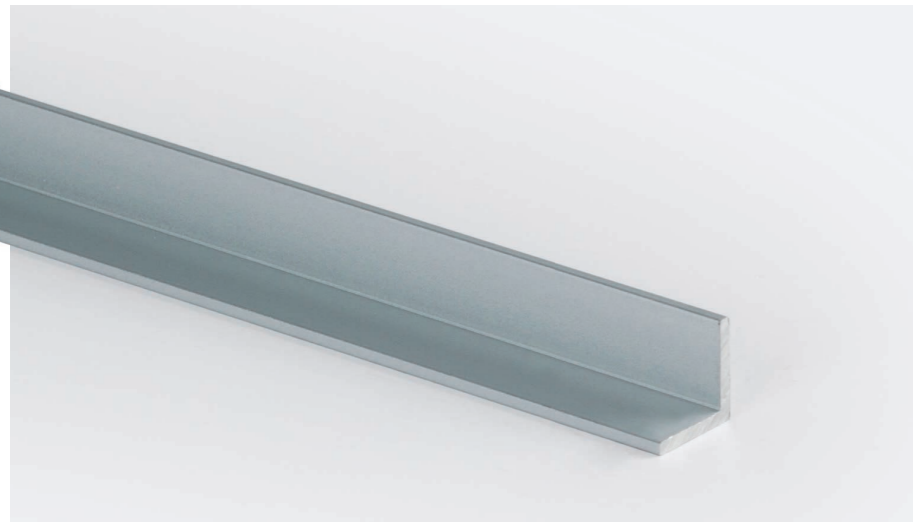

**19,2 W/m**  
Max. Power.

**13 mm**  
Max. Width

Effective dimensions  
Dimensioni utili

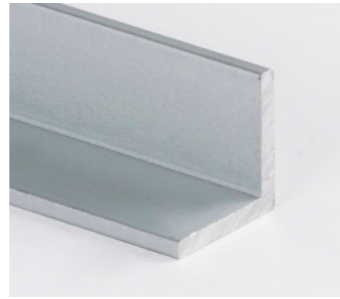

Cut to size  
Taglio su misura

Aluminium heat sink plate for corners, L-shaped, 15x15 mm.  
Piastra di dissipazione di alluminio angolare a L, 15x15 mm.

AL  
5063A  
BODY

150 g/m

IP20

IK08

PL  
RAL9007

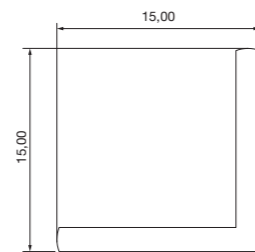

Max Width: 13 mm

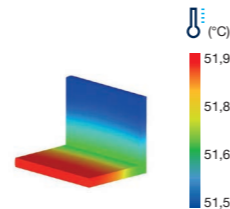

1:1 Scale

2 m Custom max.  
PF1515CHAN PF1515CHCMAN RAL 9007 19,2 W/m

Which measure do you need? Contact us!  
Di che misura hai bisogno? Contattaci!

## PRO DAO PF1235CH

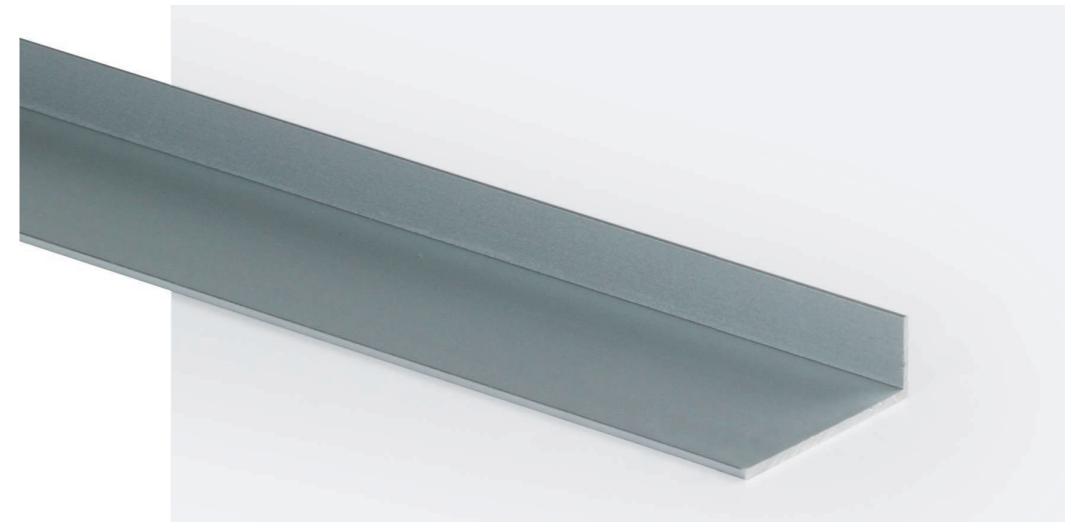

**38,4 W/m**  
Max. Power.

**34 mm**  
Max. Width

Effective dimensions  
Dimensioni utili

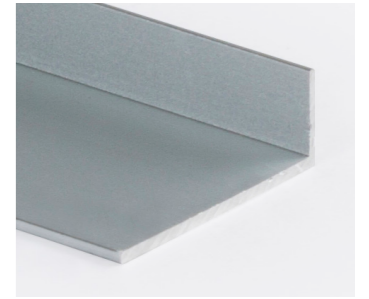

Cut to size  
Taglio su misura

Aluminium heat sink plate for corners, L-shaped, 35x12 mm.  
Piastra di dissipazione di alluminio angolare a L, 35x12 mm.

AL  
5063A  
BODY

162 g/m

IP20

IK08

PL  
RAL9007

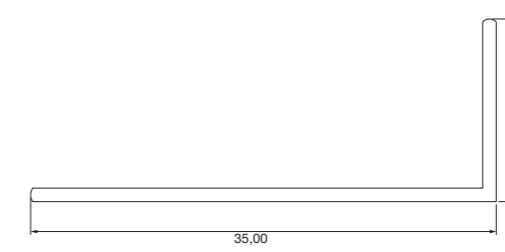

Max Width: 34 mm

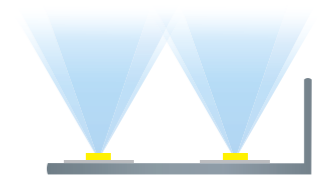
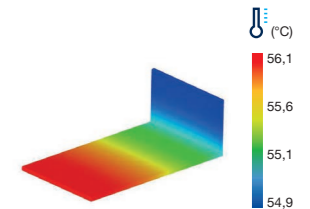

1:1 Scale

2 m Custom max.  
PF1235CHAN PF1235CHCMAN RAL 9007 38,4 W/m

Which measure do you need? Contact us!  
Di che misura hai bisogno? Contattaci!

## PROFILES ACCESSORIES / ACCESSORI PER PROFILI

## RECESSED MOUNTING / DA INCASSO

## APF5002



Special clamp. Easy to install.  
*Pinza speciale. Installazione facilitata.*

68x45x1,6 mm.

## APF5004

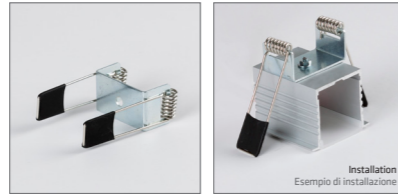

Special mounting clip with screw.  
*Pinza speciale con vite.*

63x48x1,2 mm.

## APF5006



Clamp for wide profiles.  
Single clamp ref., order 2 pcs.  
*Pinza per profili larghi.  
Codice per una pinza, ordinare 2 pzz.*

54x51x8 mm.

## APF5017

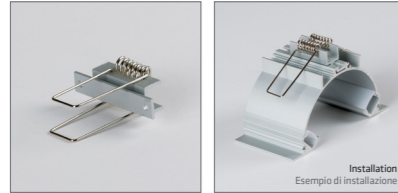

Clips for profile PF10149EM.  
*Pinza per profilo PF10149EM.*

45x45x1,6 mm.

## SUSPENSION MOUNTING / SOSPENSIONE

## APF5001



Steel cable. / *Cavo di acciaio.*  
1 m.

## APF5000



Steel cable. / *Cavo di acciaio.*  
2 m.

## APF5013

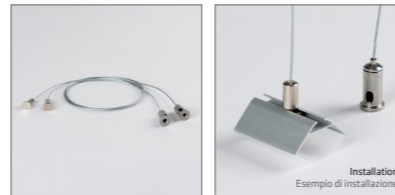

Steel cable. / *Cavo di acciaio.*  
3 m.

## CLAMP / FISSAGGIO

## APF5003



Easy to install clamp.  
Single clamp ref., order 2 pcs.  
*Pinza installazione facilitata.  
Codice per una pinza, ordinare 2 pzz.*

61x58x1,4 mm.

## APF5007

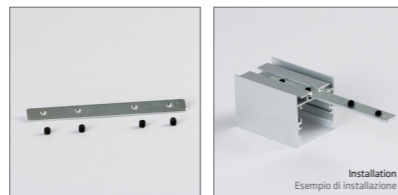

Straight connection/clamp accessory.  
*Accessorio di unione/fissaggio dritto.*

95x9mm.

## PROFILES ACCESSORIES / ACCESSORI PER PROFILI

## CONNECTION / UNIONE

## APF5005

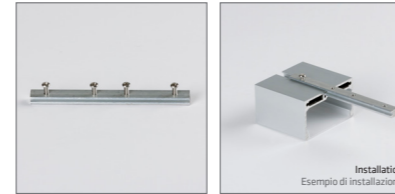

Straight connection accessory.  
*Accessorio di unione dritto.*

99x10x5,5 mm.

## APF5008



"L"-shaped flat connection accessory.  
*Accessorio di unione piatto 'L'.*

50x50x1,6 mm.

## APF5009



"L"-shaped connection accessory.  
*Accessorio di unione 'L'.*

49x49x1,7 mm.

## APF5014

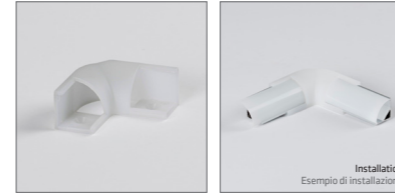

Corner connection accessory for  
profile PF1615EQ.  
*Accessorio di unione angolare per  
profilo PF1615EQ.*

46x46x2 mm.

## APF5015

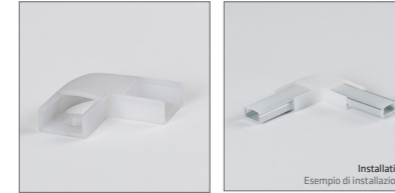

Corner connection accessory for  
profile PF1708SP.  
*Accessorio di unione angolare per  
profilo PF1708SP.*

46x46x1,3 mm.

## DIFFUSERS / DIFFUSERES

## DFP1122C1M



Transparent diffuser metre.  
Width 12,5 mm.

*Metro de diffusore trasparente.  
Larghezza 12,5 mm.*

## DFP1322C1M



Transparent diffuser metre.  
Width 32 mm.

*Metro de diffusore trasparente.  
Larghezza 32 mm.*



Colour diffuser metre.  
Width 12,5 mm.

*Metro di diffusore colorato.  
Larghezza 12,5 mm.*

- DFP01127VEC1M
- DFP01124ROC1M
- DFP01123NEC1M
- DFP01126AZC1M
- DFP01125NAC1M



# Controllers

## Controller

Customise your designs / Personalizza il tuo impianto

Independent control / Controllo indipendente

Types of controllers / Tutti i tipi di controller

## Control

Using LED strip controllers, you can create different atmospheres by dimming the intensity or colour of lighting, adjusting effect modes or transition speed. You can achieve the desired effect depending on the space or the moment.

All our strips can be controlled independently and there is a wide variety of possibilities depending on the function: Mobile, remote, wall-mounted, push-button, DALI, DMX, SLESA, use in facilities or by remote control.











We also have signal amplifiers required for strip installations of more than 10 metres in series or when total power of the installation exceeds the power allowed by the controller.

*Grazie ai controller per strip LED è possibile creare diversi ambienti regolando l'intensità e il colore della luce, la modalità e la velocità di transizione. Puoi ottenere l'effetto che vuoi a seconda dell'ambiente o del momento.*

*Tutte le nostre strip LED possono essere controllate in maniera indipendente ed esiste un'ampia varietà di possibilità a seconda della modalità: controllo con smartphone, con telecomando, a parete, con pulsante, DALI, DMX, SLESA, con gestione fisica dall'impianto oppure da remoto.*

*Offriamo anche amplificatori di segnale, necessari per installazioni più lunghe di 10 metri lineari di strip LED o quando la potenza totale dell'impianto supera quella massima permessa dal controller.*

# LED STRIP CONTROLLERS / CONTROLLER PER STRIP LED

	DIGITAL	0/1-10V	DALI	WALL TOUCH	MULTIZONE WALL TOUCH
<b>24Vdc LED STRIPS</b>					
<b>SINGLE-COLOUR LED STRIPS</b>					
<b>SINGLE-COLOUR NEON FLEX</b>		 TDIM12A Page 146	 CRTDAW Page 147	 4TW Page 148	
<b>TWO-COLOUR LED STRIPS</b>				 4TBI Page 148	
<b>RGB LED STRIPS</b>			 CRTDARGBI Page 147		
<b>RGB NEON FLEX</b>				 4TRGB Page 148	
<b>RGB+W LED STRIPS</b>			 CRTDARGB+W Page 147	 4TRGB+W Page 148	 4TDX8 DX8RF Page 149
<b>RGB+TW LED STRIPS</b>					
<b>DIGITAL LED STRIPS</b>	 CTRxD Page 146				

WALL TOUCH + RF	RF REMOTE	MULTIZONE RF REMOTE	DMX	CASAMBI	SMART HOME WIFI	AMPLIFIERS
 4TRTW Page 150	 RTW Page 151	 RTMZ / R3MWBI Page 152				 AMPLEDW Page 158
 4TRTBI Page 150	 RTBI Page 151	 RTMZBI / R3MWBI Page 152	 CTRSCNRGB Page 154	 CSB1224DC Page 156		 AMPLEDBI Page 158
 4TRTRGB Page 150	 RTRGB Page 151	 RTMZRGBW / R4MRGBW Page 153	 CTRDECDMXV2 * Page 154	 CSB4SWNE Page 156		 AMPLEDRGBN Page 158
	 CTRLEDRGB Page 151			 CSB4SWBL Page 156	 SMART-CRT Page 157	 AMPLEDRGB Page 158
 4TRTRGB+W Page 150	 RTRGB+W Page 151	 RTMZRGBW / R4MRGBW Page 153	 CTRDMXRGB+W * Page 154			 AMPLEDRGB+W Page 159
	 RTMZRGBTW / R5MRGBTW Page 151	 RTMZRGBTW / R5MRGBTW Page 153				 AMPLEDBI / AMPLEDRGBN Page 159

SLESA

\*SLESA interfaces for DMX controllers available.  
\*Disponibili interfacce SLESA per controller DMX.

Page 155

LED STRIPS / STRIP LED

PROFILES / PROFILI

CONTROLLERS / CONTROLLER

POWER SUPPLIES / ALIMENTATORI

# LED STRIP CONTROLLERS / CONTROLLER PER STRIP LED

## DIGITAL LED STRIPS

Specific controllers for digital LED strips, where each minimum section of the strip will be controlled independently, offering different colour change options (flash, sweeps, etc.) and speed.

*Controller specifici per strip LED digitali, che vengono controllate in maniera indipendente per ogni segmento minimo di strip LED, offrendo diverse opzioni per il cambio di colore (flash, carrelate, ecc) e velocità.*

## 0/1-10V

The 0/1-10V dimming system requires an additional 0/1-10V dimmer based on the variation of the output signal. This allows the luminous flux to be dimmed between 1 and 100% through an additional analogue control signal with +/- polarity, which must be respected.

The push-button also allows the output luminous flux to be dimmed, switching it on and off by connecting it directly to the controller.

*Il sistema di regolazione 0/1-10V ha bisogno di un regolatore 0/1-10V aggiuntivo e si basa sulla variazione del segnale di uscita, che permette una regolazione del flusso luminoso da 1 a 100% attraverso un segnale analogico addizionale al controller, con polarità +/- da rispettare.*

*Il pulsante, oltre alla regolazione del flusso luminoso in uscita, permette anche l'accensione e lo spegnimento collegandolo direttamente al controller.*

## DALI

Digital and addressable dimming system, which allows compatibility and interchangeability between pcs from different manufacturers.

It is a two-way communication system with a structure consisting of a master: Controller; and several slaves: Drivers, controllers and sensors; which execute commands and respond to requests.

There is no need for mechanical devices for switching on, switching off and dimming, this is done by commands through the control line.

Communication within the system is carried out via a 2-wire bus or control line, without polarity and without the need for special shielded cables, in this way, the wiring can be a combination: power supply line + DALI bus (5 wires).

Installation design allows for great flexibility and its settings can be changed at any time.

Addressing of the individual components is performed via software:

- Up to 64 drivers/controllers, individually.
- Up to 16 drivers/controllers in groups.
- All of these are simultaneous via the "broadcast" command.

*Sistema di regolazione digitale e direzionabile, che permette la compatibilità e intercambiabilità tra apparecchi di diversi produttori.*

*Si tratta di un sistema bidirezionale, con una struttura formata da un master (il controller), e vari slaves (driver, controller e sensori), che eseguono i comandi e rispondono agli input.*

*Non c'è necessità di dispositivi meccanici per l'accensione, lo spegnimento e la regolazione, che vengono effettuati da comandi mediante la linea di controllo.*

*La comunicazione all'interno del sistema viene realizzata attraverso un bus o linea di comando a due fili, senza polarità e senza bisogno di cavi speciali schermati, per cui il cablaggio può essere eseguito insieme: linea di alimentazione + bus DALI (5 fili).*

*La progettazione dell'impianto permette una grande flessibilità, la configurazione può essere modificata in qualsiasi momento.*

*L'indirizzamento di ciascun prodotto avviene via software:*

- Fino a 64 driver/controller, individualmente;
- Fino a 16 driver/controller, in gruppo;
- Simultaneamente con il comando "broadcast".

## WALL TOUCH CONTROLLERS

Touch controllers with specific outputs for the desired LED strip type, which are installed in conventional wall-mounted switch boxes. This system allows dimming and colour matching, saving specific settings for later selection, as well as the selection of dynamic modes.

*Controller touchscreen con uscite specifiche per il tipo di strip LED desiderato, che viene installato direttamente nelle scatole da incasso a parete e permette di regolare l'intensità e il colore, salvare configurazioni per ripristinarle in un secondo momento, e selezionare modalità dinamiche.*

## WALL TOUCH CONTROLLERS + RF

Wall-mounted touch controller similar to the previous model, which includes an RF controller to control the strip from both devices: Remote control or wall-mounted controller.

*Controller touchscreen a parete come il precedente modello, ma che include un telecomando a radiofrequenze per controllare la strip LED da entrambi i dispositivi: telecomando e controller a parete.*

## RF REMOTE CONTROLS

Controllers via RF remote control with specific outputs for the desired LED strip type, allowing the appropriate dimming of intensity and colour and the selection of dynamic modes.

*Controller con telecomando RF con uscite specifiche per il tipo di strip LED desiderato, che permette di regolare l'intensità e il colore, e di selezionare modalità dinamiche.*

## MULTIZONE RF REMOTE

Solution that allows up to 4 different zones to be controlled with the same remote control, with a different controller in each one of them. Both the remote control and the controllers are specific to the type of LED strip desired, and allow the intensity and colour to be adjusted and dynamic modes to be selected, for a specific zone or for several at the same time.

*Soluzione che permette di controllare con lo stesso telecomando fino a 4 zone diverse, ciascuna con il proprio controller. Sia il telecomando che i controller sono specifici a seconda del tipo di strip LED installato e permettono di regolare l'intensità e il colore, e di selezionare modalità dinamiche di una zona in particolare o di più di una zona in contemporanea.*

## DMX

DMX (Digital MultipleX) is an electronic protocol used for professional lighting management and control. It is often used for architectural, stand, stage and TV studio lighting.

DMX512 protocol is based on the use of "channels" to transmit control commands to the pcs in the facilities, with a limit of 512 channels per universe. In addition, the values of each channel can be adjusted from 0 to 255.

In LED strip installations, each channel will control one colour, i.e., 1 channel is required for single-colour strips, 2 channels for two-colour strips, 3 channels for RGB, and 4 channels for RGB+W.

These channels are controlled from a mixing console or via dedicated software.

*DMX (Digital MultipleX) è un protocollo elettronico utilizzato per la gestione e il controllo dell'illuminazione professionale. Solitamente viene usato per illuminazione architettonica di facciate, illuminazione di scena, di stand e di set televisivi.*

*Il protocollo DMX512 si basa sull'utilizzo di "canali" per la trasmissione di ordini di controllo agli apparecchi dell'impianto, con il limite di 512 canali per universo. Inoltre, ogni canale può essere regolato dal valore 0 al valore 255.*

*In un impianto con strip LED, ogni canale controllerà un colore, ossia, per le strip LED monocolori c'è bisogno di un canale, per le bicolore di due canali, per le RGB di tre canali e per le RGB+W di quattro canali.*

*Questi canali vengono controllati attraverso un mixer o con un software specifico.*

## SLESA

Specific interfaces and software solution for DMX control of lighting facilities.

With these, and using a PC, it is possible to implement specific scenes, time programming the same, achieving local or remote control of the facilities via internet.

*Soluzione di interfacce e software specifico per il controllo DMX di impianti di illuminazione.*

*Offre la possibilità, attraverso un computer portatile, di implementare scene specifiche, di impostarne la programmazione temporale e di controllare l'impianto a livello locale o in remoto via internet.*

## CASAMBI

CASAMBI is a wireless system that creates its own network between the connected devices so as to retransmit the signals to any device in the network, even in cases where it is not near the signal emitting point. In addition to local control, the system can be remotely controlled via an Internet-connected gateway

This controller has 4 independent PWM output channels, which can be configured for single-colour, two-colour, RGB or RGBW strip control.

Play which allows us to create scenes, groups, and animated graphics intuitively and quickly. One Casambi network supports up to 250 devices and it is possible to integrate unlimited CASAMBI networks.

*CASAMBI è un sistema wireless che crea la propria rete tra i dispositivi connessi per poter ritrasmettere i segnali a qualsiasi dispositivo della rete, anche se distante dal punto di origine. Oltre al controllo locale, può essere controllato in remoto tramite un Gateway connesso a internet.*

*Questo controller ha 4 canali di uscita PWM indipendenti, che possono essere configurati per il controllo di strip LED monocolori, bicolore, RGB o RGB+W.*

*In una rete CASAMBI è possibile collegare fino a 250 dispositivi ed è possibile integrare un numero illimitato di reti CASAMBI.*

## SMART HOME (WIFI)

By combining the WIFI network and Bluetooth technology, these controllers allow us to manage the facilities from our mobile device.

With these, it is possible to manage the facilities via Alexa and Google Home.

They provide absolute, automated and remote control of the lighting, easily operating and executing the orders from the APP of the Smartphone or by remote controls.

*Controller che combinano la rete WIFI e la tecnologia Bluetooth per manipolare l'impianto dal nostro dispositivo mobile.*

*Permettono il controllo dell'impianto attraverso Alexa e Google Home.*

*Forniscono un controllo assoluto, automatizzato e non in presenza dell'illuminazione, operando comodamente e impartendo i comandi dalla APP dello smartphone o con telecomandi a distanza.*

## AMPLIFICADORES

LED strip installations may require a strip length greater than 10 metres (maximum length to be connected continuously) or a length of strip that consumes more power than allowed by the selected controller.

This problem is avoided through the use of amplifiers, in which case, it is possible to install all the desired metres under the same controller, achieving complete uniformity of the facilities will not be a problem, since it is possible to install all the desired metres under the same controller to achieve complete uniformity of the installation.

*Un impianto di strip LED può essere formata da più di 10 metri lineari (limite massimo per lunghezza continua) o utilizzare un tipo di strip LED che consuma più potenza di quella permessa dal controller scelto.*

*Usando un amplificatore questo non rappresenterà un problema, sarà possibile installare tutti i metri desiderati con lo stesso controller ottenendo una totale uniformità dell'impianto.*

# DIGITAL / DIGITALE

## CTRXD



Controller for digital strips.  
Controller per strip LED digitali.

**Input** **Output**  
 5-24Vdc DMX512/1990 6803 3001 176x46x30 mm  
 8806 9813  
 2811 1814  
 2801 6812

# 0/1-10V / 0/1-10V

## TDIM12A



### CONNECTION DIAGRAM / SCHEMA DI CONNESSIONE

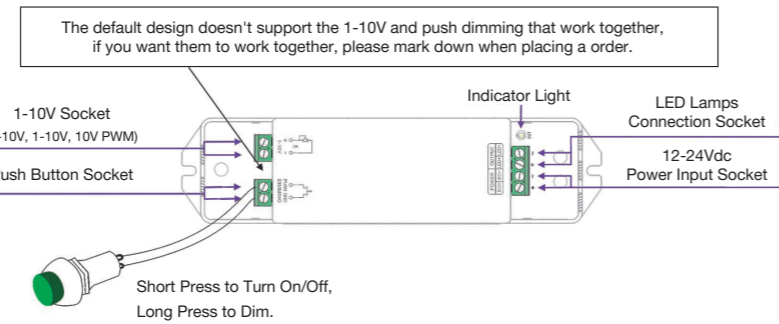

**Input**  
 12-24Vdc 12Ax1Ch 144W (12V) -30° - 55° C 175x44x30 mm 0/1-10V  
 288W (24V)

# DALI / DALI



## CRTDAW



**Input**  
 12-24Vdc 10Ax1Ch 120W (12V) -20° a 50° C 176x46x30 mm DALI  
 240W (24V)

## CRTDARGBI



**Input**  
 12-24Vdc 5Ax3Ch 180W (12V) -20° a 50° C 176x46x30 mm DALI  
 360W (24V)

## CRTDARGB+W



**Input**  
 12-24Vdc RGB: 3Ax3Ch W: 9Ax1Ch RGB: 36Wx3Ch / W: 108W (12V) -20° a 50° C 176x46x30 mm DALI  
 RGB: 72Wx3Ch / W: 216W (24V)

### CONNECTION DIAGRAM / SCHEMA DI CONNESSIONE

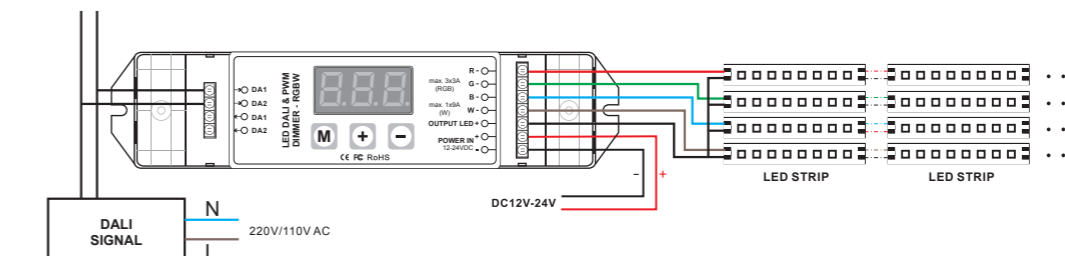

# WALL TOUCH / TOUCHSCREEN PARETE

## 4TW



- 12-24Vdc
- CH 4Ax4Ch 16A(max)
- W 192W (12V) 384W (24V)
- 20° - +55° C
- 86x86x36 mm

## 4TBI



- 12-24Vdc
- CH 4Ax4Ch 16A(max)
- W 96W (12V) 192W (24V)
- 20° - +55° C
- 86x86x36 mm

## 4TRGB



- 12-24Vdc
- CH 4Ax3Ch 12A(max)
- W 144W (12V) 288W (24V)
- 20° - +55° C
- 86x86x36 mm

## 4TRGB+W



- 12-24Vdc
- CH 4Ax4Ch 16A(max)
- W 192W (12V) 384W (24V)
- 20° - +55° C
- 86x86x36 mm

# MULTIZONE WALL TOUCH / TOUCHSCREEN PARETE MZ

## 4TDX8 / DX8RF



- 110-240Vac 50/60Hz
- CH RF 2.4G + DMX512
- 20° - +55° C
- 86x86x36 mm
- 12-24Vdc
- CH 5Ax4Ch 20A(max)
- W 240W (12V) 480W (24V)
- 30° a 50° C
- 46x176x30 mm

### CONNECTION DIAGRAM / SCHEMA DI CONNESSIONE

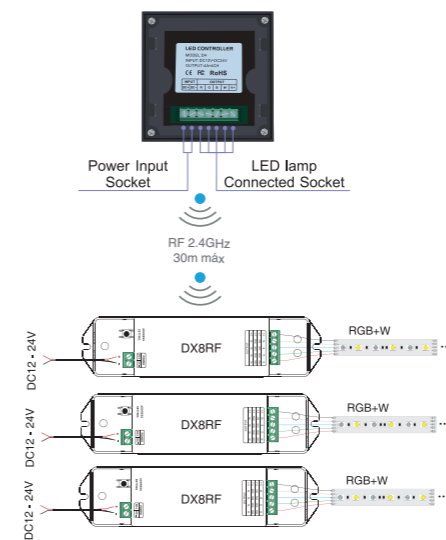

## WALL TOUCH + RF / TOUCHSCREEN PARETE + RF

### 4TRTW



### 4TRTBI



### 4TRTRGB



### 4TRTRGB+W

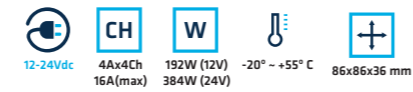

## CONNECTION DIAGRAM / SCHEMA DI CONNESSIONE

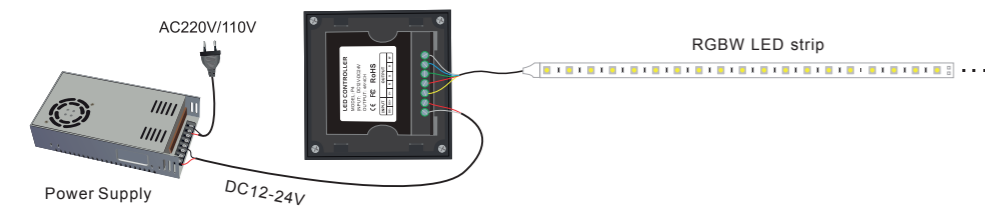

## RF (RADIOFREQUENCY) / RF (RADIOFREQUENZA)

### RTW

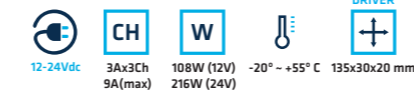

### RTBI



### RTRGB

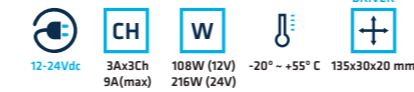

### CTRLEDRGB



### RTRGB+W

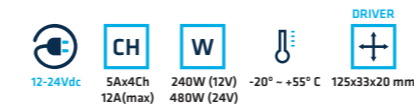

### RTMZRGBTW / R5MRGBTW

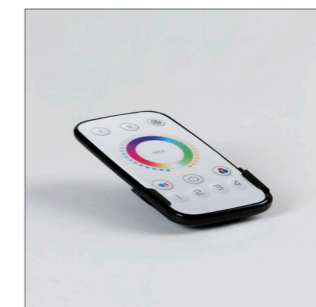

\*Battery (CR2032) not included in the remote control / \*Batteria (CR2032) non inclusa nel telecomando

## MULTIZONE RF / RF MULTIZONA

### RTMZW

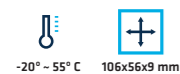
Receiver: **R3MWBI**

-20° - +55° C 106x56x9 mm

### RTMZBI

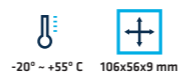
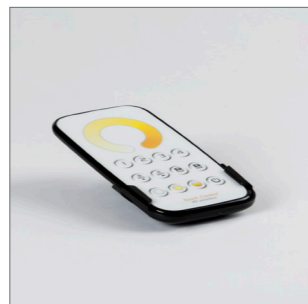
Receiver: **R3MWBI**

-20° - +55° C 106x56x9 mm

### R3MWBI

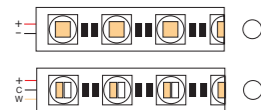

1 x Zona



12-24Vdc 3Ax3Ch 108W (12V) 216W (24V) -30° - +55° C 135x29x20 mm

## MULTIZONE RF / RF MULTIZONA

### RTMZRGBW

Receiver: **R4MRGBW**

-20° - +55° C 106x56x9 mm

### RTMZRGBTW

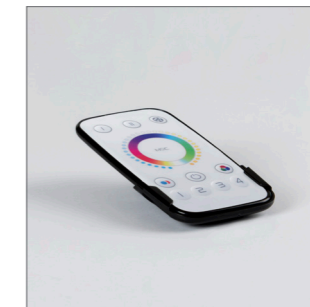
Receiver: **R5MRGBTW**

-30° - +55° C 104x58x9 mm

### R4MRGBW



1 x Zona

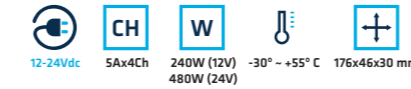

12-24Vdc 5Ax4Ch 240W (12V) 480W (24V) -30° - +55° C 176x46x30 mm

### R5MRGBTW



1 x Zona



12-24Vdc 3Ax5Ch 180W (12V) 360W (24V) -25° - +50° C 91x37x21 mm

### CONNECTION DIAGRAM / SCHEMA DI CONNESSIONE

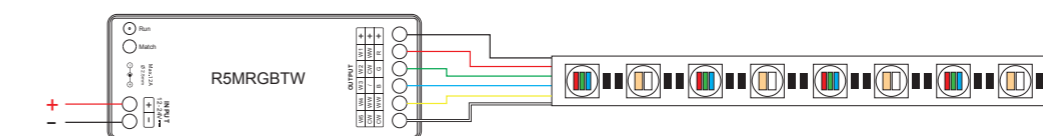

\*Battery (CR2032) not included in the remote control / \*Batteria (CR2032) non inclusa nel telecomando

\*Battery (CR2032) not included in the remote control / \*Batteria (CR2032) non inclusa nel telecomando

# DMX / DMX

## CTRSCNRGB

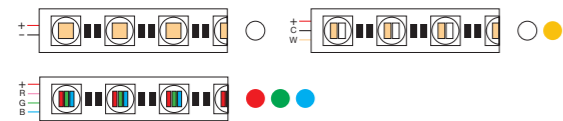

- 5-24Vdc
- CH 6Ax3Ch (max. 18A)
- W 220W (12V) 432W (24V)
- 20° ~ +50° C
- 142x88x30 mm
- Input DMX 512/1990
- 16 levels per channel scale (256 levels per channel)

## CTRDECDMXV2

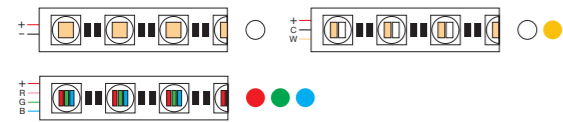

- 12-24Vdc
- CH 8Ax3Ch 24A (max.)
- W 288W (12V) 576W (24V)
- Input DMX512/RDM
- Output 3Ch constant voltage PWM

- DMX 3Ch XLR-3 standard
- Levels 8bit (256) 16bit (65536)
- 30° ~ +65° C
- 122x110x37 mm

## CTRDMXRGB+W

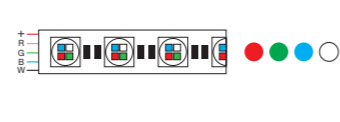

- 12-24Vdc
- CH RGB: 3Ax3Ch W: 9Ax1Ch
- W RGB: 36Wx3Ch (12V) W: 108W (12V) RGB: 72Wx3Ch (24V) W: 216W (24V)
- Input DMX512/1990

- Output 4Ch constant voltage PWM
- DMX 4Ch XLR-3 standard
- Levels 256
- 176x46x30 mm

### CONNECTION DIAGRAM / SCHEMA DI CONNESSIONE

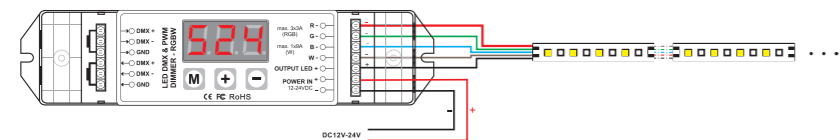

# INTERFACE / INTERFACE

## DMX Interface

### SLESA-U9



### SLESA-U10



### SLESA-U11



	SLESA-U9	SLESA-U10	SLESA-U11
Dimensions	77 x 87 x 40 mm	77 x 87 x 40 mm	160 x 905 x 45 mm
USB connection	✓	✓	✓
Ethernet connection			✓
WiFi connection		✓	
DMX Channels	256	512	1024 (expandable to 2048)
Number of scenes	20	99	99
Number of zones	1	1	5
Standalone memory	20k	100k	microSD
Memory capacity (20 ch.)	1200	3935	unlimited
Memory capacity (60 ch.)	440	1550	unlimited
Memory capacity (512 ch.)		190	unlimited
Power connector	mini USB	USB Type-C	USB Type-C
Internal connector	HE 10	HE10	
Port triggers	8	8	16
Clock / calendar triggers			unlimited
Remote control apps		✓	✓



## CASAMBI BLUETOOTH

### CSB1224DC

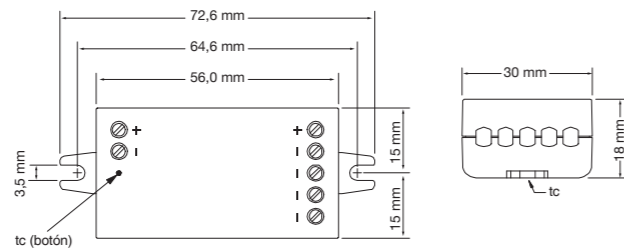

- 12-24Vdc
- CH 4Ch 6A (max)
- Wout 72W (12V) 144W (24V)
- 30 m
- 50 m
- 20°~+45° C

#### CONNECTION DIAGRAM / SCHEMA DI CONNESSIONE

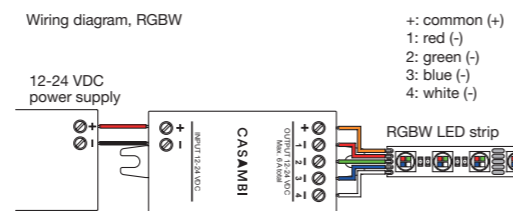
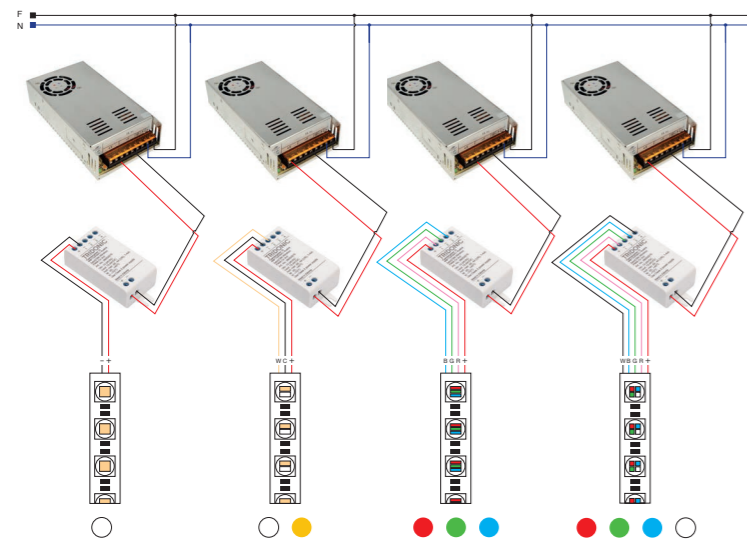

## CASAMBI ACTUATORS / INTERRUTTORI

### CSB4SWNE



### CSB4SWBL

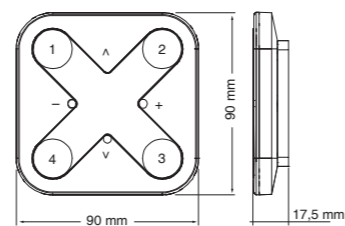

- NE CR2430 (1 piece) 2 to 5 years IP20 -0°~+45° C
- BL CR2430 (1 piece) 2 to 5 years IP20 -0°~+45° C

## (WIFI) SMART HOME / SMART HOME (WIFI)

### SMART-CRT

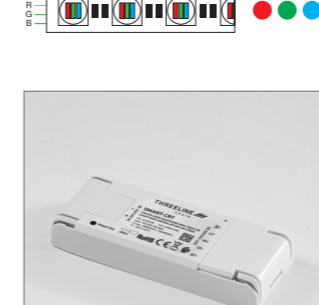

Compatibility with voice assistants and applications:

Compatibile con assistente vocale e APP:

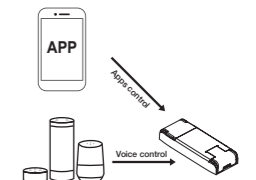

- 12-24Vdc
- W 96W (12V) 192W (24V)
- Vout 12V/24V 8A Max
- F 2,4-2,4835 GHz
- 20°~+50° C
- 115x45x18 mm

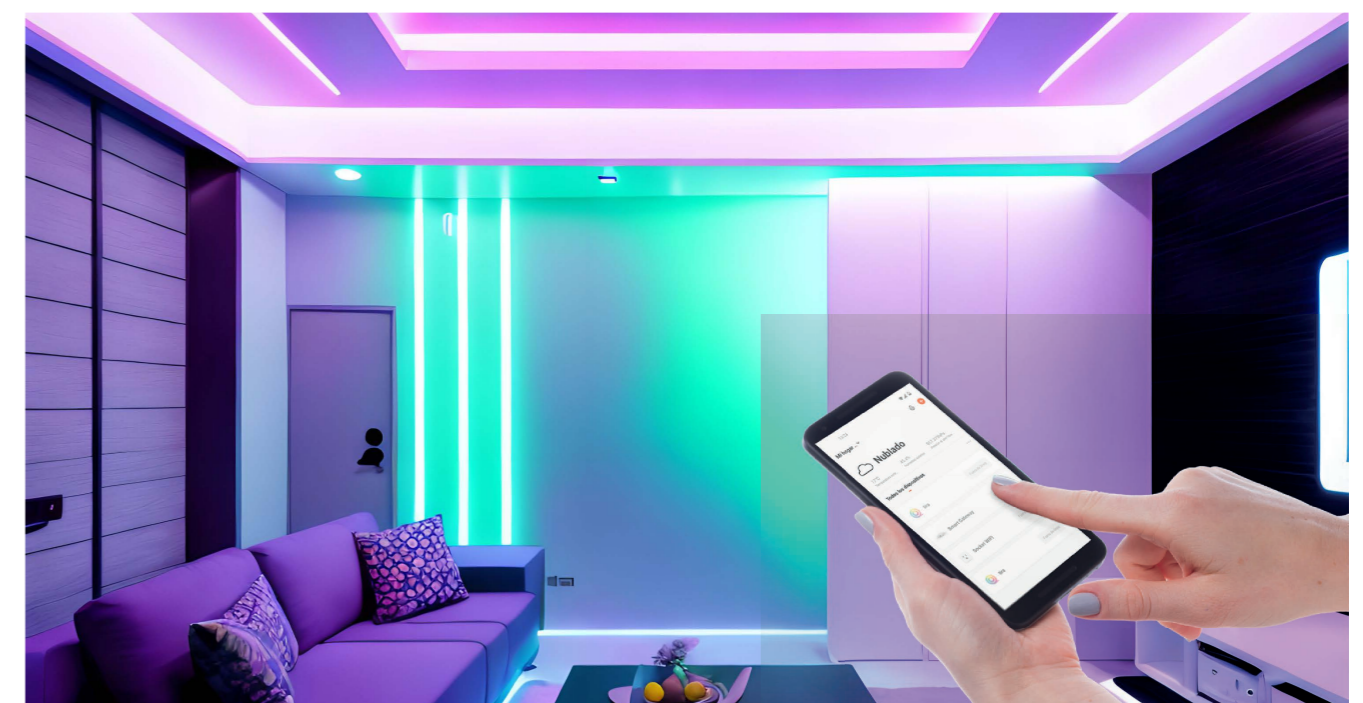

#### CONNECTION DIAGRAM / SCHEMA DI CONNESSIONE

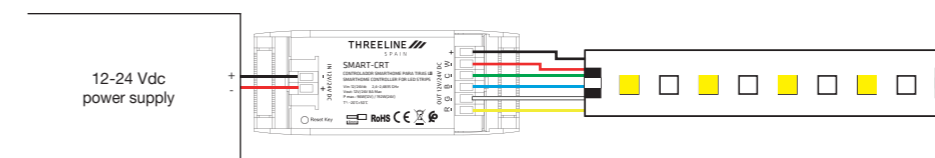

## LED STRIP AMPLIFIERS / AMPLIFICATORI STRIP LED

## AMPLEDW

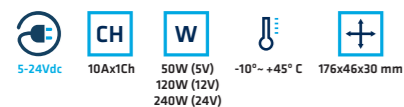

## AMPLEDBI

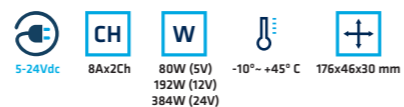

## LED STRIP AMPLIFIERS / AMPLIFICATORI STRIP LED

## AMPLEDRGB+W

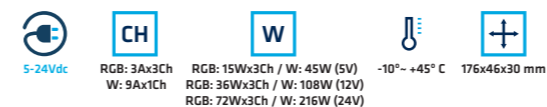

## AMPLEDRT



## AMPLEDRGBN

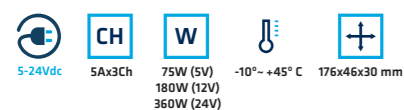

## AMPLEDRGB

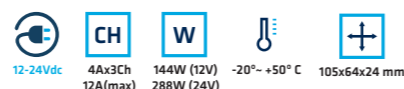

## AMPLEDBI / AMPLEDRGBN



# Power Supplies

## Alimentatori

Enclosed power supplies / Alimentatori con griglia

Compact power supplies / Alimentatori compatti

Slim power supplies / Alimentatori slim

Waterproof power supplies / Alimentatori stagni

## Power

Threeline Technology offers a wide range of power supplies, such as the constant voltage drivers needed to supply power to the LED strips.

All our power supplies have a 24Vdc constant voltage output.

There is an extensive range of solutions for powering LED strips, with different wattages and voltages for each strip. Threeline power supplies fall into the following categories: enclosed, waterproof, compact and slim.

Our technical department will provide you with all the advice you need to carry out your project.

*Noi di Threeline ti offriamo un ampio catalogo di alimentatori, driver con tensione costante necessari per l'alimentazione delle strip LED.*

*Tutti i nostri alimentatori hanno una tensione costante in uscita di 24Vdc.*

*Le possibilità per alimentare le strip LED sono davvero moltissime e di diversa potenza. I nostri alimentatori sono di diverso tipo: con griglia, stagni, compatti e slim.*

*Il nostro ufficio tecnico ti fornirà tutta l'assistenza necessaria per portare a termine il tuo progetto.*

# CV POWER SUPPLIES / ALIMENTATORI CV

## ENCLOSED IP20 / CON GRIGLIA IP20



VLED24R35W

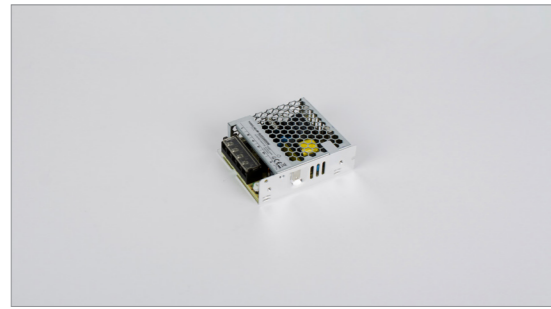

36W 100x82x30 mm

VLED24R60W

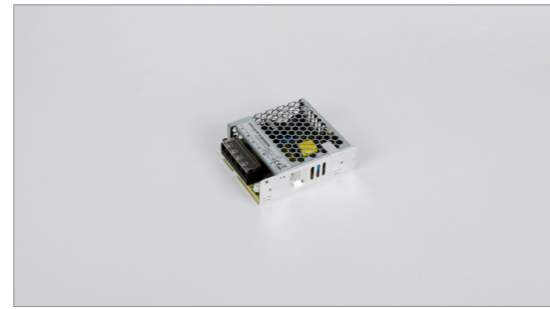

60W 100x82x30 mm

VLED24R100W



108W 125x95x30 mm

VLED24R150W

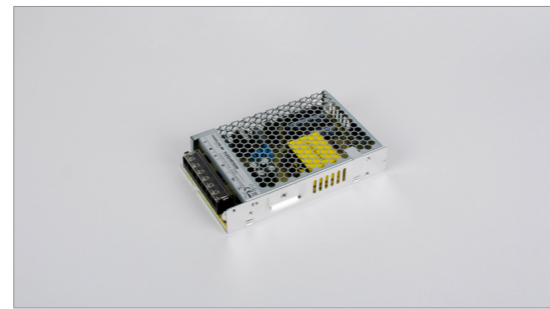

156W 159x97x30 mm

VLED24R250W

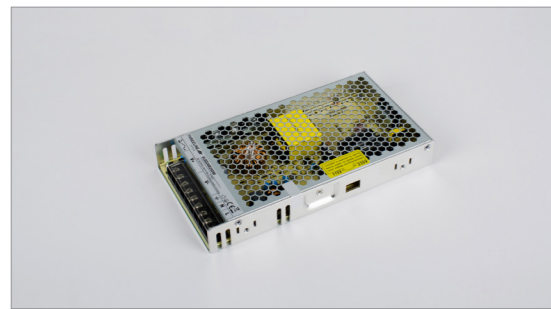

240W 215x115x30 mm

# CV POWER SUPPLIES / ALIMENTATORI CV

## ENCLOSED IP20 / CON GRIGLIA IP20



VLED24R350W



350W 215x115x30 mm

VLED24R400W



396W 215x115x30 mm

# CV POWER SUPPLIES / ALIMENTATORI CV

## COMPACT ON-OFF IP20 / COMPATTI ON-OFF IP20



**DTC24-30W**



**DTC24-60W**



**DTC24-75W**



**DTC24-120W**



**DTC24-150W**



# CV POWER SUPPLIES / ALIMENTATORI CV

## COMPACT DALI-PUSH IP20 / COMPATTI DALI-PUSH IP20



**D2P20-45-24**



**D2P20-80-24**



**D2P20-150-24**



**D2P20-250-24**



# CV POWER SUPPLIES / ALIMENTATORI CV

## SLIM IP20 / SLIM IP20



# CV POWER SUPPLIES / ALIMENTATORI CV

## SLIM IP20 / SLIM IP20



### DTLIN24-30W



### DTLIN24-60W



### DTLIN24-100W



### DTLIN24-160W



# CV POWER SUPPLIES / ALIMENTATORI CV

## WATERPROOF ON/OFF IP67 / STAGNI ON/OFF IP67



VLED24-E30W



VLED24-E60W



VLED24-E100W



VLED24-E150W



VLED24-E250W



# CV POWER SUPPLIES / ALIMENTATORI CV

## WATERPROOF DALI-PUSH IP66 / STAGNI DALI-PUSH IP66



D2P66-100-24



D2P66-150-24



D2P66-200-24



D2P66-300-24



# TERMS AND CONDITIONS OF SALE

## CONDIZIONI DI VENDITA



### QUALITY AND WARRANTY

All products are subject to quality tests and are guaranteed for 2, 3 or 5 years against manufacturing faults. Please refer to the specific product quality and warranty document.

This warranty does not cover damage caused by misuse, improper handling or installation.

Threeline Technology, S.L. is continuously improving the quality and performance of its products and reserves the right to modify or remove any of them without notice.

### SHIPMENT

Shipment will be prepaid in orders with values greater than the stipulated one. Check conditions with Commercial Department.

Shipment on orders under this amount may be prepaid by Threeline Technology, S.L. In such cases, a surcharge equal to the shipment cost will be added to the invoice. The fee will be established according to the shipping company's current rates.

### QUALITÀ E GARANZIA

*Tutti i nostri prodotti vengono sottoposti a numerose prove di qualità e sono garantiti per un periodo di 2, 3 e 5 anni contro qualsiasi difetto di fabbrica. Consultare il documento sulla qualità e sulla garanzia per ciascuno dei prodotti.*

*Questa garanzia non copre i danni subiti per uso improprio, scorretta manipolazione o installazione impropria.*

*Threeline Technology, S.L., nella continua ricerca per migliorare la qualità e la funzionalità dei suoi prodotti, si riserva il diritto di modificare o eliminare uno qualunque di essi senza preavviso.*

### SPEDIZIONI

*Tutti gli ordini di importo superiore a quanto pattuito verranno spediti in porto franco. Consultare le condizioni specifiche con la Direzione Commerciale.*

*Gli ordini di importo inferiore potranno essere spediti a carico della Threeline Technology, S.L., addebitando in fattura il costo di spedizione. Tale costo sarà stabilito in base alla tariffa in vigore concordata con la società di trasporti.*

### DELIVERY TIMES

Although we strive to meet our delivery times, they are not always estimated according to parameters controlled by Threeline Technology, S.L. Therefore, we cannot always guarantee full compliance. Threeline Technology, S.L. shall not be liable for damages arising from delayed delivery.

### METHOD OF PAYMENT

Payment terms and conditions shall always be those agreed with the customer. Payment due dates by means of any legally accepted payment document must be duly honoured. Failure to pay shall immediately void any agreed commitments.

### CLAIMS

Claims for the condition of goods or shipment errors shall not be accepted more than 10 working days from receipt.

### REPAIRS

Within the warranty period, defective materials shall be repaired or replaced at no cost to the customer. Where the warranty is applicable, our liability is limited to the free delivery of a new product replacing the damaged one or to the full reimbursement of the price of the defective goods. Any liability for damages, expenses, charges or compensations is expressly excluded.

### RETURNS

All returns must be approved in advance by Threeline Technology, S.L.

Returns or shipments of materials to Threeline Technology, S.L. facilities either for reimbursement, replacement or repair must be paid by the customer.

Returns will not be accepted on materials that are custom-made, expressly ordered for the customer or specifically modified by Threeline Technology, S.L.

Products returned for reasons beyond the control of Threeline Technology, S.L. must be in perfect condition for sale and listed in the current price list. Returns shall be refunded in full minus a 10% inspection and handling fee.

### TERMINI DI CONSEGNA

*Anche se i termini di consegna vengono rispettati in una percentuale molto alta, bisogna tenere in conto che non sempre sono calcolati in base a parametri controllati da Threeline Technology, S.L., per questo motivo non possiamo garantirne sempre il rispetto al 100%. La Threeline Technology, S.L. non accetta richieste di risarcimento danni da parte del cliente per un ritardo di consegna.*

### MODALITÀ DI PAGAMENTO

*Le condizioni di pagamento sono concordate con i nostri clienti. Le scadenze dei pagamenti tramite qualsiasi documento di pagamento legalmente accettato dovranno essere rispettate puntualmente. I ritardi di pagamento comportano l'immediato annullamento di tutti gli impegni assunti.*

### RECLAMI

*In nessun caso si accetteranno reclami sullo stato della merce o su errori degli ordini dopo 10 giorni lavorativi dalla data di ricevimento degli stessi.*

### RIPARAZIONI

*Entro il periodo di garanzia, la riparazione o la sostituzione dei materiali difettosi viene effettuata senza alcun costo per il cliente. In tutti i casi nei quali risulta esigibile la garanzia, la nostra responsabilità si limita alla consegna gratuita di un nuovo prodotto per sostituire quello danneggiato o al rimborso integrale del prezzo del prodotto in questione, escludendo espressamente qualsiasi responsabilità per danni e interessi o qualsiasi altra spesa, onere o risarcimento.*

### RESI

*Tutti i resi devono essere preventivamente autorizzati dalla Threeline Technology, S.L.*

*I resi o le spedizioni di materiali alle strutture della Threeline Technology, S.L. al fine di rimborso, sostituzione o riparazione, dovranno sempre essere effettuate franco destino.*

*Non si ammetteranno resi di prodotti realizzati su misura o fatti arrivare espressamente per il cliente o sui quali Threeline Technology S.L. abbia apportato qualche modifica specifica.*

*La merce restituita per motivi non imputabili alla Threeline Technology, S.L. deve essere in perfette condizioni per la rivendita e e riportata nel listino prezzi in vigore. Il materiale sarà rimborsato al suo valore netto meno una detrazione minima del 10% a titolo di partecipazione ai costi di revisione e gestione.*



# WARRANTY POLICY / POLITICA DI GARANZIA

Threeline faulty products shall be covered by the warranty. Note that:

- The warranty, depending on the product, takes effect from the invoice date.

- Upon request an extended warranty or a customised project warranty may be offered after assessment by the technical department. The extended warranty shall be deemed effective when accompanied by a quality and guarantee certificate associated with the quote and/or delivery note number.

- This warranty is valid only for products sold in the EMEA region (Europe, Middle East and Africa). Other conditions may apply in other regions.

- Products must be properly installed and operate in accordance with the manufacturer's instructions.

- This warranty does not cover labour costs for product assembly and disassembly.

- A Threeline representative shall inspect defective products. Should there be any doubts regarding products or other parts, the Threeline representative has the right to refer to representatives from other manufacturers to assess the lighting systems.

- The warranty period is based on a maximum of 3,000 hours of operation per year at a room temperature of 25°C and a 10mm gap around the products.

- This warranty only covers normal use of the product and does not cover damage caused by misuse, improper handling or installation.

Normal installation and operating conditions according to Threeline are as follows:

- Operating conditions are in line with the information on the product packaging.

- Products must not be exposed to temperatures exceeding standard room temperature. Installation or use in extreme environmental conditions should be consulted with the factory for approval.

- The relative humidity of the installation must never exceed the product IP rating.

- Products must operate in an open luminaire (closed luminaire for LED tube) with a minimum 10mm gap around the product.

- Products must not be subject to more than 20,000 fast switching cycles (time between switch-on and switch-off less than 10 minutes).

- The wiring to which the product is connected must not be subject to voltage fluctuations within a range exceeding 230V ±10%.

*I prodotti Threeline che non funzionano correttamente a causa di difettosità degli stessi durante il periodo specificato sono coperti dalla garanzia THREELINE:*

- *Il periodo di garanzia dura da due a cinque anni in funzione del prodotto, con inizio dalla data della fattura.*

- *Su richiesta, sarà possibile valutare un'estensione della garanzia o offrire una garanzia di progetto personalizzata, una volta che l'Ufficio Tecnico ne avrà valutato le condizioni di applicazione. La garanzia si intenderà estesa quando sia accompagnata da un certificato di qualità e garanzia associato al numero di preventivo e/o bolla di consegna.*

- *La presente garanzia è valida solo per i prodotti venduti nella regione EMEA (Europa, Medio Oriente e Africa). In altre regioni potrebbero essere applicate altre condizioni.*

- *I prodotti devono essere correttamente installati e funzionare in base alle istruzioni del produttore.*

- *La presente garanzia non copre i costi di manodopera per lo smontaggio e il montaggio dei prodotti.*

- *Un incaricato di Threeline avrà accesso ai prodotti difettosi. Se il prodotto, o alcune componenti, fossero oggetto di dubbi, l'incaricato avrà diritto a chiedere a rappresentanti di altri fabbricanti una valutazione del sistema di illuminazione.*

- *Il periodo di garanzia si basa su un funzionamento massimo di 3.000 h annue a una temperatura ambiente di 25 °C e con una distanza di almeno 10 mm intorno al corpo dei prodotti.*

- *Questa garanzia copre solo i prodotti che non sono stati usati in maniera difforme all'uso per il quale sono stati creati e non copre i danni subiti per uso improprio, errata manipolazione o installazione impropria.*

*Le normali condizioni di installazione e funzionamento secondo Threeline sono le seguenti:*

- *Le condizioni di funzionamento sono conformi alle informazioni riportate sulla confezione dei prodotti.*

- *La temperatura alla quale il prodotto può essere esposto non deve superare la normale temperatura ambiente. Per installazioni e utilizzo in condizioni ambientali particolari o estreme occorre consultare l'azienda per eventuali approvazione.*

- *L'umidità relativa dell'installazione non deve mai superare il grado IP del prodotto.*

- *I prodotti devono funzionare in una lampada aperta (lampada chiusa per un tubo LED) con almeno 10 mm d'aria intorno al corpo dei prodotti.*

- *I prodotti non devono essere sottoposti complessivamente a più di 20.000 commutazioni rapide (tempo on-off di accensione- spegnimento inferiore a 10 minuti).*

- *L'impianto elettrico in cui funziona il prodotto non deve essere soggetto a fluttuazioni un intervallo superiore a 230 V +/- 10%.*

## TERMS AND CONDITIONS

- Threeline's warranty applies only to the buyer, provided that the buyer returns the products covered by this warranty within the period established.

- The product must be sent perfectly packaged to Threeline Technology, S.L.'s address. The customer shall be liable for any damage occurred during transport.

- This warranty is only valid when the product has been properly connected and installed, and is operating at the electrical values, operating range and environmental conditions set forth in the specifications, application guides, IEC standards or any other document supplied with the product.

- Threeline shall repair or replace, at its sole discretion, the defective product or component, or reimburse the buyer for the purchase price. For the sake of clarity, 'repair or replace the defective product or component' shall include without limitation labour costs or expenses, but in no case, activities, costs or expenses of removal and re-installation.

- If Threeline decides to replace the product, but is unable to do so as it is no longer manufactured or available, Threeline may reimburse the buyer for the amount paid or replace the product with a similar one (design or specifications may vary slightly).

- Agents, distributors or representatives are not authorised to alter, amend or extend any aspect of the warranty terms and conditions stipulated by Threeline.

- If the warranty claim is valid, Threeline shall bear the shipping costs. Threeline may charge the customer for non-defective or non-conforming returned products together with the incurred shipping, inspections and management costs.

- This is a limited warranty and excludes, without limitation, installation, access to products (scaffolding, lifts, etc.) and special, incidental or consequential damages (such as loss of profit, property damage or other extended costs not mentioned above). Extended definitions of limitations and conditions can be found in the relevant warranty policy and in these conditions.

- Threeline is not responsible for power supply conditions, including voltage spikes, voltage fluctuations, and ripple control systems exceeding specified product limits and those defined in relevant supply standards (e.g. EN 50160).

- Regarding third-party branded products sold by Threeline to the buyer, Threeline makes no warranty, express or implied, including without limitation warranties of merchantability or fitness for a particular purpose. However, upon request Threeline shall provide the buyer with the relevant product manufacturer's warranties only to the extent permitted by the applicable law and contracts.

## TERMINI E CONDIZIONI

- *La garanzia di Threeline si applica esclusivamente all'acquirente, purché questi restituisca i prodotti coperti dalla presente garanzia entro il periodo di applicazione stabilito.*

- *Il prodotto deve essere inviato perfettamente imballato all'indirizzo della Threeline Technology, S.L. Il cliente è responsabile per i danni subiti durante il trasporto.*

- *Questa garanzia è valida solo se il prodotto è stato collegato e installato correttamente, e sta funzionando con i valori elettrici, l'intervallo di funzionamento e le condizioni ambientali di cui alle specifiche, alle linee guida, alle norme IEC o a qualsiasi altro documento fornito con i prodotti.*

- *Threeline riparerà o sostituirà, a sua discrezione, il prodotto o componente difettoso dello stesso, o rimborserà all'acquirente l'importo del prezzo di acquisto. Per evitare confusioni, l'espressione "riparerà o sostituirà il prodotto o componente difettoso dello stesso" includerà senza restrizioni i costi o le spese della manodopera, ma in nessun caso le attività, i costi o le spese di smontaggio e rimontaggio.*

- *Se Threeline sceglie di sostituire il prodotto, ma si trova nell'impossibilità di farlo perché non viene più fabbricato o non è disponibile, può restituire all'acquirente l'importo pagato o sostituire il prodotto con uno analogo (il cui design o specifiche possono variare leggermente).*

- *Gli agenti, i distributori o i rappresentanti non sono autorizzati a cambiare, modificare o estendere nessun aspetto delle condizioni di garanzia stabilite da Threeline.*

- *Quando la richiesta di garanzia è giustificata, le spese di spedizione saranno a carico di Threeline. Threeline potrà fatturare al cliente i prodotti restituiti che non siano difettosi o non conformi insieme ai relativi costi di trasporto, verifica e gestione.*

- *La presente è una garanzia limitata ed esclude, tra le altre voci, l'installazione, i mezzi di accesso ai prodotti (impalcatura, montacarichi, ecc.), e danni speciali, diretti e indiretti (quali ad esempio, la perdita di profitti economici/ mancato guadagno, danni alla proprietà o altri costi estesi non precedentemente menzionati), ed è ulteriormente definita dalle limitazioni e dalle condizioni previste nella garanzia relativa e nei presenti termini e condizioni.*

- *Threeline non è responsabile delle condizioni di fornitura elettrica, inclusi i picchi di tensione, gli sbalzi di tensione e i sistemi di controllo di ondulazione di corrente che superino i limiti specificati dei prodotti e quelli definiti dalle norme di alimentazione specifiche (per esempio, le norme EN 50160).*

- *Per quanto riguarda i prodotti venduti da Threeline all'acquirente ma non a marchio Threeline, l'azienda non offre alcuna garanzia, esplicita o implicita, incluse, senza alcuna limitazione, le garanzie di commerciabilità o idoneità per uno scopo determinato; tuttavia, mette a disposizione dell'acquirente, su richiesta, ma solo nella misura consentita dalla legge e dai relativi contratti, le garanzie del fabbricante del prodotto in questione.*

NOTES / NOTE

Lined area for notes on page 174.

NOTES / NOTE

Lined area for notes on page 175.

# DESIGN AND LAYOUT / *LAYOUT E IMPAGINAZIONE*

© Threeline marketing department

Printed: March 2024.

Reproduction in whole or in part of the images, texts, illustrations and graphics in this catalogue is prohibited without prior written consent from THREELINE TECHNOLOGY, S.L.

Due to technical printing processes, the colours printed in this catalogue may vary from the original product colour. The information included herein is correct except for typos.

Due to the continuous improvement and constant evolution of our products, Threeline reserves the right to modify the technical specifications, as well as to update the technical values and product features in the technical data sheets available at:

[www.threelinegroup.com](http://www.threelinegroup.com)

Threeline Technology S.L. reserves the right to modify products without notice.

© Ufficio Marketing di Threeline

Stampa: Marzo 2024.

*È vietata la riproduzione totale o parziale di immagini, testi, illustrazioni ed elementi grafici di questo catalogo senza la preventiva autorizzazione della THREELINE TECHNOLOGY, S.L.*

*A causa dei processi tecnici di stampa, i colori stampati in questo catalogo possono subire variazioni rispetto al colore originale del prodotto. I dati contenuti in questo catalogo possono essere soggetti a errori.*

*A seguito del continuo miglioramento e della costante evoluzione dei nostri prodotti, Threeline si riserva il diritto di modificare le specifiche tecniche, nonché di aggiornare i valori tecnici e le caratteristiche dei prodotti nelle loro schede tecniche, disponibili su:*

[www.threelinegroup.com](http://www.threelinegroup.com)

*La Threeline Technology S.L. si riserva il diritto di modificare il prodotto senza alcun preavviso.*

**Headquarters**  
Pol. El Mugerón · C/ Pulimentadores, 1 · Apdo. 633  
02640 Almansa (Albacete) · Spain  
T. +34 967 318 293 · F. +34 967 340 002  
export@threeline.es  
**ThreelineGroup.com**

**Sede Legale:** Viale dei Primatei Sportivi, 21 · 00144 Roma · ITALIA  
**Magazzino Deposito Merci:** Viale A.G. Eiffel, 100  
c/o Commercium Modulo M21 · 00148 Roma · ITALIA  
T. +39 06 40410166  
info@threelineitalia.it · threelineitalia@legalmail.it  
**ThreelineGroup.com/it**

THREELINE 