

THREELINE 

2023 | CATÁLOGO



36 Downlights Downlights

38 OREGON+



DL040R / DL060R DL040C / DL060C

40 UTAH



DLU40R

41 CALIFORNIA+



OFD10 / OFD20 / OFD28

42 BOSTON



DLB10 / DLB20
DLB28 / DLB35 / DLB45

44 MONTANA



DLM08C / DLM12C DLM08R / DLM12R
DLM18C / DLM25C DLM18R / DLM25R

45 ALASKA



DL25WUGRIP65

46 NEVADA



ND10R / ND16R ND10C / ND16C
ND20R ND20C

48 NEVADA



ND10R-S / ND16R-S ND10C-S / ND16C-S
ND20R-S ND20C-S

50 MISURI



MSR12R
MSR18R
MSR24R
MSR30R

51 MICHIGAN



DC20R

52 IRIS



MINIDLO3C / MINIDLO3R



MINIDLO7C / MINIDLO7R
MINIDLO7CD / MINIDLO7RD



MINIDLO12C / MINIDLO12R

56 Plafones Plafons

58 CEILING+



CEL12 / CEL18 / CEL32

59 TECTUM+



TCT18C / TCT18R / TCT24H

60 Paneles Painéis

62 ACROPOLIS



P6060EUGR65

63 METROPOLIS



P60X60EUGR9

65 TRIPOLIS



P6060UGR / P30120UGR / P60120UGR

66 MICROPOLIS



P3030 / P3060

68 NEOPOLIS



PS6060UGR

70 NEAPOLIS

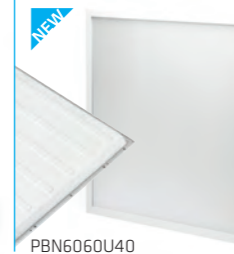

PBN6060U40

71 EXAPOLIS



PBE606040

74 Lineales Lineares

78 SKYLINE



SKL

84 TURIA

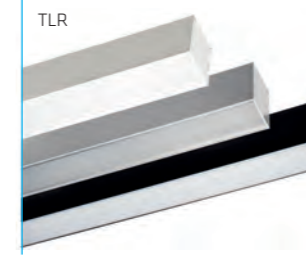

TLR

94 ALTHEA



LTS

96 Lámparas Lâmpadas

98 LITIO



LN5W / LN7W
LN7WD / LC5W

100 ZINC



GN45-5W / GN45-7W
GN45-7WD

102 GOLD



GOLD45 / GOLD37V
GOLD60 / GOLD64 / GOLD95

104 HELIO



B80-9W / B95-13W
B120-16W

104 RADON



R8010W / R9010W

105 CROMO



QR111N13 / QR111N13D

106 PALADIO



PL20E / PL40E

107 PLUTONIO



PLL10W
PLL19W
PLL21W

107 GALIO



G42 / G94

96 Lámparas Lâmpadas

108 PLOMO



PAR20IP65-5W

108 PLOMO



PAR306510W
PAR386518W
PAR38658WVE ●

110 PLATINO



PAR56 ●●● PAR56-S ●●●

112 Tubos Tubos

114 TIUB PLUS



T83260UL / T83290UL
T832120UL / T832150UL
T832180UL

115 TIUB



T8GP60 / T8GP90
T8GP120 / T8GP150

116 TIUB GLASS



T8EG60 / T8EG90
T8EG120 / T8EG150

118 TIUB MEAT



T8FM60 / T8FM90
T8FM120 / T8FM150

119 TIUB FRUIT



T83260UL / T83290UL
T832120UL / T832150UL
T832180UL

120 TIUB 24V



T824V60 / T824V120
T824V150

121 TIVE



T5R30 / T5R60
T5R90 / T5R120 / T5R150

Illuminación Industrial Iluminação Industrial

122

124 Pantallas Estancas Armaduras Estanques

126 KATIA



PE118
PE136
PE158

PE218
PE236
PE258

128 KLAUS



KLS60-10 / KLS60-20
KLS120-20 / KLS120-40
KLS150-25 / KLS150-55

132 TAKAT



TKT60-20
TKT120-40
TKT150-55

134 Campanas Campânuas

136 CLOE



CQM104AG7

CQM208AG7

CQM312AG7

CQM416AG7

CQM520AG7

144 TELLY

NEW



HBT100 / HBT150 / HBT200

148 ISI

NEW



HBI100 / HBI150 / HBI200

150 Proyectores Projetores

152 PALAU



QMP1040

154 PANAMA



QMP104NN7



PQM208NN7



PQM312NN7



PQM416NN7



PQM520NN7

162 OLYMPIC II

NEW



OLP1500 / OLP1800

OLP0300

OLP0600

OLP0900

OLP1200

170 LYON

NEW



PRL020
PRL030

PRL050
PRL080

PRL100
PRL150

PRL200
PRL240

PRL300
PRL400

178 IPROY



IPRN10W / IPRN20W
IPRN30W / IPRN50W
IPRN100W / IPRN150W
IPRN200W

180 IVO

NEW



PRI010 / PRI020
PRI030 / PRI050
PRI100 / PRI150

182 Gasolineras Gasolineras

183 FIUL



FIU060 / FIU100 / FIU150 / FIU200

Illuminación Vial
Iluminação Vial

184

186 Luminaria Vial Luminária Vial

188 RUA



CVL CVM CVS

194 KALE



KVS

KVXL

KVL

KVM

195 URBAN



URBANR_CV / URBANB_CV

196 VILLA



VILLA_CV

197 FERNANDINA



FERNANDINA_CV

199 Grupo Óptico Grupo Óptico

199 NUIT



NUI20 / NUI30 / NUI40 / NUI50

Illuminación Decorativa
Iluminação Decorativa

200

202 Tracklight Tracklight

204 APOLO



CRPOL09 EMPOL09 SPPOL09
CRPOL18 EMPOL18 SPPOL18
CRPOL30 EMPOL30 SPPOL30

206 HERMES



CRH3040C9

208 ARES



CRA1420 / CRA2130

210 METIS



CRMTS / SP1MTS / SP2MTS
SP3MTS / SP4MTS

211 ACCESORIOS



212 Tiras LED Fitas LED

214 **TRAKA**
T3528300
T3528600
T5050150
T5050300
MONOCOLOR

MANA
XM2835060
XM2835120
XM5050060

218 **TRAKA**
T2835490
T5630300
ALTA EFICIENCIA

HALEN
XH2835060
XH2835120
XH2835240

220 **PRIEST**
XP2835240
ALTA DENSIDAD

221 **NAS**
XN2110060
ESPECIAL

SUEDE
XS2835120

222 **TRAKA**
T5050300RGB
T5050300RGB+W
RGB / RGB+W

XUA
XX5050060RG
XX5050060RW

224 **DUNCAN**
XD5050060P65RG
XD5050060P65RW
DIGITAL RGB

225 **TRAKA**
T3527300BI
T2835560BI
T3528600BI
BICOLOR

BLONDIE
XB3527060
XB2835112
XB3528120

228 **TRAKA**
T3014600
LATERAL

LIZ
XL3014120

229 **ACCESORIOS**

230 **ABBA**
XA2835075
230Vac

236 Perfiles Perfis

237 **TIBER**
SUPERFICIE
PF06195P / PF14145P
PF17085P / PF17145P
PF30115P / PF30215P
PF19195P / PF35255P
PF35415P / PF42355P

241 **BENI**
SUPERFICIE CURVA
PF25075C
PF39095C
PF52085C

242 **NILE**
EMPOTRABLE
PF2314EM / PF2508EM
PF4435EM / PF5035EM
PF6545EM / PF7032EM
PF10149EM

246 **LEAN**
COLGABLE / SUPERFICIE
PF2929CL / PF2930CL
PF3535CL / PF5074CL
PF5532CL

248 **ACRE**
ARQUITECTÓNICO
PF5424AR / PF5815AR
PF6320AR / PF7435AR
PF3545AR / PF6214AR

250 **KONDA**
ESQUINAS
PF1615EQ
PF1818EQ

251 **RENO**
ESCALERA / ESQUINA
PF6826EL
PF6828EL

236 Perfiles Perfis

252 SELE



SUELO
PF2711SL / PF1609SL
PF1613SL / PF2226SL

254 EBRO

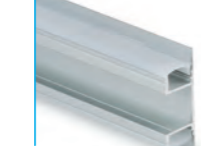

PARED
PF4213PD / PF4913PD
PF7060PD / PF4084PD

256 OKOA



TUBO
PF0430TB

256 GANGES



RODAPIÉS
PF8016RD

258 DAO

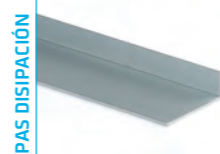

CHAPAS DISIPACIÓN
PF1503CH / PF1508CH
PF1515CH / PF1235CH

260 ACCESORIOS Y DIFUSORES

Electrónica

Electrónica

262

266 Controladores Tiras LED Controladores Fitas LED

266 CORTE DE FASE



PCD240W

267 DIGITAL



CTRXD

268 0/1-10V



TDIM12A

269 DALI



CRTDAW
CRTDARGBI
CRTDARGB+W

270 TÁCTIL PARED



4TW
4TBI
4TRGB
4TRGB+W

271 TÁCTIL MULTIZONA



4TDX8 / DX8RF

272 TÁCTIL PARED +RF



4TRTW
4TRTBI
4TRTRGB
4TRTRGB+W

273 RF



RTW / RTBI / RTRGB
CTRLEDRGB / RTRGB+W

274 RF MULTIZONA



RTMZW / RTMZBI / RTMZRGBW
R3MWBI / R4MRGBW

275 DMX



CTRSCNRGB / CTRDECDMX
CTRDMXRGB+W

276 BLUETOOTH



CSB1224DC

277 WIFI SMART HOME



SMART-CTR

278 Controladores Luminarias Controladores Luminárias

278 CORTE DE FASE



PCD240W

279 0/1-10V



PARED: DIM110VRLT
PARED + RF: DIM110VRLTRT
PARED TÁCTIL: DIM110V4T
RF: DIM110VRT / MDRF
MDMRF1
RF MULTIZONA: MDRF
MDMRF4

281 DALI



DALI_TP_B_C

282 Pasarelas Gateway

283 DALI → TRIAC



DALI_RDG2

283 CASAMBI → TRIAC



CSBTRAC

283 DALI → 0/1-10V



PDALID110

284 CASAMBI → DALI - 0/1-10V



CSB110DA

282 Pasarelas Gateway

284 PULSADOR TRAD. → DALI



DALIXC

284 DMX → 0/1-10V



PDMX110

285 ZIGBEE → 0/1-10V



PDALID110

285 DALI → PWM



DALI-PWM

286 Amplificadores Amplificadores

286 TIRAS LED



AMPLEDW
AMPLEDBI
AMPLEDRGBN
AMPLEDRGB
AMPLERGB+W
AMPLEDRT

287 DALI



R_DALI

288 Fuentes Fontes

288 Vcte | REJILLA



VLED24R35W
VLED24R60W
VLED24R100W
VLED24R150W
VLED24R250W
VLED24R350W
VLED24R400W

289 Vcte | ESTANCAS



VLED24-E30W
VLED24-E60W
VLED24-E100W
VLED24-E150W
VLED24-E250W

290 Vcte | COMPACTAS



DTC24-30W / DTC24-60W
DTC24-75W / DTC24-120W
DTC24-150W

291 Vcte | SLIM



DTLIN24-30W / DTLIN24-60W
DTLIN24-100W / DTLIN24-160W

292 Icte



DM250-700mA
DM800-2000mA

293 DALI



DALIPS1
DALIPS2

294 Sensores Sensores

294 ON/OFF



SP20 / SP65

295 1-10V



SC65B / SC65C / MSC65 / SL20

296 CASAMBI



CSB20SMBL / CSBE230ACS

297 DALI



SP20 / SP65

298 KE Kit Emergência

298 KIT DE EMERGENCIA



KET85
KEU603
KEL101
KEU2403V2
KEIP65V2

300 OTROS Outros

300 INTERFACE



SLESA-U9
SLESA-U10
SLESA-U11
DALL.USB

301 ENCHUFES



CSBE230AC

301 ACTUADORES



CSB4SWNE
CSB4SWBL

302 PROTECTORES



NSB-10/230-C4-WW-IP
NSB-10/230-CA-DD

303 INTERRUPTORES



DIP23
PMEC23

304 TEMPORIZADORES



TMEC23

304 CONECTOR GU10



305 CONECTORES ESTANCOS



WCIP65
WCIP65B2
WCIP65B3

+16 años de experiencia
anos de experiència

33 presencia en 33 países
presente em 33 países

4.5k más de 4.500 artículos
mais de 4.500 artigos

1.5k más de 1.500 clientes
mais de 1.500 clientes

Sobre nosotros

En THREELINE somos un equipo joven y dinámico que trabaja día a día ofreciendo la mejor versión de nosotros para hacer crecer la marca y situarla como principal referente en el mercado LED.

Nacimos en Almansa (España) en el año 2006 como una empresa de electrónica para iluminación que ha evolucionado hasta la fecha ofreciendo todo tipo de iluminación LED.

El Departamento de I+D y el Departamento Técnico trabajan en nuestro propio laboratorio desarrollando productos novedosos y ofreciendo a nuestros clientes asesoramiento en todo tipo de proyectos de iluminación.

Nuestro principal objetivo es apostar por un producto de calidad a precios competitivos y con una gran eficiencia, consiguiendo un ahorro energético de más del 80%.

Idiomas

Nuestro equipo está preparado para atenderles en:



Hablamos Español



We speak English



On parle Français



Noi parliamo Italiano



Nós falamos Português

Sobre nós

Na THREELINE somos uma equipa jovem, dinâmica e que trabalha dia a dia, dando o nosso melhor para fazer crescer a marca e situá-la como principal referência no mercado LED.

Nascemos em Almansa (Espanha), em 2006, como uma empresa de eletrónica para iluminação tendo evoluído até à data e oferecendo todo tipo de iluminação em LED.

O departamento de I+D, juntamente com o departamento Técnico, trabalham no nosso próprio laboratório para desenvolver novos produtos e oferecer aos nossos clientes aconselhamento sobre todos os tipos de projetos de iluminação.

O nosso principal objetivo é apostar em produtos de qualidade a preços competitivos e com grande eficiência, conseguindo uma economia energética de mais de 80%.

Idiomas

A nossa equipa está preparada para o receber em:

I+D y Control de Calidad

Hablar del Departamento Técnico, I+D y Control de Calidad de THREELINE es hablar realmente de un solo ente enfocado, en gran medida, a la investigación, el diseño y el desarrollo de nuevos productos y soluciones, así como al constante y exhaustivo control de calidad en todas las fases del proceso de fabricación.

Para ello, contamos con un gran número de herramientas específicas:

- Impresoras 3D para hacer realidad los primeros diseños y prototipos, desarrollados por ordenador, antes de llevar a cabo la producción a gran escala.
- Cámara termográfica para realizar análisis detallados de la temperatura alcanzada en cada momento por todos los componentes que conforman un producto y poder determinar la existencia de puntos críticos, así como las limitaciones y rangos de temperatura de los productos.
- Láser para el marcado y la diferenciación de las referencias y números de lotes, lo que permite tener una trazabilidad total de cada producto de forma personalizada e independiente.
- Esfera integradora de Ulbricht para la obtención objetiva de parámetros eléctricos, fotométricos y colorimétricos de los productos.

I+D e Controlo de Qualidade

O Departamento Técnico, I&D e Controlo de Qualidade da THREELINE formam uma única entidade focada sobretudo em pesquisar, idealizar e desenvolver novos produtos e soluções, bem como controlar constante e exaustivamente a qualidade de todas as fases do processo de produção.

Para isso, dispomos de um grande número de ferramentas específicas:

- Impresoras 3D, para tornar realidade os primeiros projetos e protótipos, desenvolvidos por computador, antes da produção em larga escala.
- Câmara térmica para analisar detalhadamente a temperatura atingida por todos os componentes que compõem um produto e ser capaz de determinar a existência de pontos críticos, bem como as limitações e máximos de temperatura do produto.
- Laser para marcação e diferenciação de referências e números de lote, o que permite rastrear cada produto de forma individual e independente.
- Esfera Integrativa de Ulbricht para obter, de forma rigorosa, parâmetros elétricos, fotométricos e colorimétricos dos produtos.

Producción

Nuestro Departamento de Producción se dedica a la constante fabricación y personalización, tanto en acabados exteriores como en opciones de regulación, de todo el material solicitado por el cliente.

Produção

O nosso departamento de Produção dedica-se ao constante fabrico e personalização, tanto em acabamentos exteriores como em opções de regulação, de todo o material solicitado pelos clientes.

Certificaciones

Certificações





Servicio al cliente

Mediante completos estudios de iluminación personalizados, siguiendo los requisitos lumínicos proporcionados por el cliente, además del cumplimiento de la normativa vigente, ofrecemos una simulación de cuál será el resultado final de su futura instalación de iluminación tanto para proyectos de interior como de exterior.

Apoyándonos en el software más avanzado, como DIALux, realizamos cálculos de iluminación en naves industriales, alumbrado público y vial, centros comerciales, instalaciones deportivas, hoteles, oficinas, restaurantes e incluso casas particulares.

Estudios de ahorro energético y amortización

Mediante cálculos sencillos y objetivos, nuestros clientes sabrán cuál será el ahorro real de sustituir luminarias tradicionales por luminarias LED de THREELINE. En el mismo estudio, además, conocerán el tiempo necesario para amortizar la inversión que supone este cambio.

Documentación Técnica

En nuestra web, y a través de los distintos departamentos, ponemos a disposición de nuestros clientes las Fichas Técnicas y los Certificados emitidos por laboratorios externos para acreditar todos nuestros productos.

Soporte Técnico

Respuesta rápida y eficaz, vía telefónica y/o email, a las dudas y consultas técnicas que tengan nuestros clientes antes de la adquisición de nuestros productos, durante la instalación de los mismos, y después de esta, gracias nuestro servicio postventa.

Asesoramiento en Proyectos

Nuestro equipo de ingenieros se encuentra a disposición del cliente para analizar sus requerimientos, estudiar sus necesidades lumínicas y orientarle en la definición final de su proyecto con un asesoramiento específico y mediante una gestión integral del mismo. Ayudamos a convertir sus ideas en proyectos mediante todo tipo de estudios e informes.

Serviço ao cliente

Através de completos estudos de iluminação personalizados, seguindo os requisitos de iluminação fornecidos pelo cliente, além da conformidade com os regulamentos atuais, tanto para projetos internos quanto externos, oferecemos uma simulação de como será o resultado final da sua futura instalação de iluminação.

Com base em softwares mais avançados, como o DIALux, realizamos cálculos de iluminação industrial, pública e rodoviária, centros comerciais, instalações desportivas, hotéis, escritórios, restaurantes e, até, casas particulares.

Estudos de poupança energética e amortização

Através de cálculos simples e objetivos, os nossos clientes saberão qual será a verdadeira poupança da mudança de luminárias tradicionais para luminárias LED THREELINE. Além disso, no mesmo estudo, poderão saber o tempo necessário para amortizar o investimento que essa mudança implica.

Documentação técnica

No nosso site, e através dos diferentes departamentos, disponibilizamos aos nossos clientes as Fichas Técnicas e os Certificados emitidos por laboratórios externos credenciados de todos os nossos produtos.

Suporte técnico

O nosso serviço pós-venda permite que os nossos clientes obtenham respostas rápidas e eficazes, por telefone e/ou e-mail, às dúvidas e consultas técnicas antes da aquisição de nossos produtos, durante a sua instalação, e após instalação dos mesmos.

Assessoria a projetos

A nossa equipa de Engenheiros está à disposição de todos os clientes para analisar os seus pedidos, estudar as suas necessidades de iluminação e orientá-los na definição final de seu projeto com assessoria específica, e através de uma gestão integral do mesmo. Ajudamos a formalizar as suas ideias em projetos, realizando para isso todo o tipo de estudos e relatórios.

Atención al cliente

El Departamento de Ventas de ThreeLine Technology S.L. ofrece a nuestros clientes un trato personalizado en todos los pedidos. Nuestros comerciales internos distribuidos por zonas te ofrecerán asesoramiento inmediato en todo el proceso de gestión de los pedidos, desde consultas de stock o precios hasta el seguimiento del material una vez se haya servido desde nuestros almacenes.

El Departamento de Atención al Cliente ofrece un servicio cercano, cordial y personalizado con el fin de que nuestros clientes obtengan el producto adecuado a sus necesidades, con la mayor celeridad posible y asegurándose un correcto uso del mismo.

Seguimiento de envíos

Nuestros clientes pueden conocer al momento el estado de sus envíos, tanto nacionales como internacionales, vía online, y de forma rápida y clara, con el número de seguimiento facilitado por las distintas compañías de transporte con las que trabajamos.

Atenção ao cliente

O Departamento de Vendas da ThreeLine Technology S.L. oferece aos nossos clientes um tratamento personalizado em todos os pedidos. Os nossos distribuidores oferecerão orientação imediata durante todo o processo de gestão de pedidos, desde consultas de stock ou preços até o seguimento do envio das suas encomendas.

O Departamento de Atenção ao Cliente presta um serviço cordial e personalizado, para que nossos clientes obtenham o produto certo de acordo com suas necessidades, o mais rápido possível e garantindo o uso correto do mesmo.

Localização de encomendas enviadas

Nossos clientes podem saber instantaneamente o estado do envio das suas encomendas, tanto nacionais como internacionais, online e de forma rápida e clara, com o número de expedição fornecido pelas diferentes empresas de transporte com as quais trabalhamos.

Centro logístico

Con más de 3.000m² de almacén logístico, repartidos en 5 instalaciones, ponemos a disposición de nuestros clientes un gran número de stock de nuestro amplio catálogo de productos, con sus distintos acabados, opciones y personalizaciones; posibilitando servirles en el menor tiempo posible y de la forma más eficaz su pedido.

Centro logístico

Os mais de 3.000m² de armazém logístico distribuídos por 5 instalações, permite-nos ter à disposição dos nossos clientes um vasto stock dos mais variados produtos do nosso extenso catálogo, com seus diferentes acabamentos, opções e personalizações, tornando possível atendê-los no menor tempo possível e da maneira mais eficiente possível.

Categorías de productos



Alta calidad
Alta qualidade



Calidad al mejor precio
Qualidade ao melhor preço



Al alcance de todos
Ao alcance de todos



¿CÓMO ELEGIR UNA LUMINARIA LED? COMO ESCOLHER UMA LUMINÁRIA LED?

Solo tienes que contestar a estas tres preguntas para elegir la luminaria LED de Threeline adecuada a tus necesidades.

Apenas deve responder a estas três perguntas para escolher a luminária LED da Threeline adequada às suas necessidades.



1. ¿Qué uso va a tener?

Que uso vai ter?

Para responder a esta pregunta puedes basarte en nuestras tres categorías de producto (ver página 9).

Para responder a esta pergunta baseie-se nas nossas três categorias de produto (ver página 9).

2. ¿Qué color debo seleccionar?

Que cor devo escolher?

Blanco Frío / Branco Frio



5500-6500K

Lugares que requieren luz potente
Locais que precisam luz potente

Garajes, Almacenes, Instalaciones sanitarias, Instalaciones deportivas, Comercios específicos.

Garagens, Armazéns, Instalações sanitárias, Instalações deportivas, Comércio específicos.

Blanco Neutro / Branco Neutro



4000-4500K

Lugares que requieren blanco puro
Locais que exigem branco puro

Oficinas, Centros educativos, Cocinas, Baños, Establecimientos comerciales.

Escritórios, Centros educativos, Cozinhas, Casas de banho, Establecimientos comerciais.

Blanco Cálido / Branco Quente



2500-3000K

Para generar un ambiente agradable
Para gerar um ambiente agradável

Dormitorios, Salones, Restaurantes, Hoteles, Halls.

Quartos, Salas, Restaurantes, Hotéis, Hall.

3. ¿Qué actividad va a desarrollarse en el lugar a iluminar?

Que atividade vai desenvolver no lugar a iluminar?

Requisitos de iluminación según actividad (NORMA UNE 12464.1):

- Edificios educativos
- Oficinas
- Bibliotecas
- Restaurantes
- Instalaciones deportivas (NORMA UNE 12193) interior y exterior.

Consultar tablas (pág. siguiente)

Requisitos de iluminação conforme a atividade (NORMA UNE 12464.1):

- Edifícios escolares
- Escritórios
- Bibliotecas
- Restaurantes
- Instalações desportivas (NORMA UNE 12193) interior e exterior.

Consultar tabelas (próxima pág.)



REQUISITOS DE ILUMINACIÓN SEGÚN ACTIVIDAD (Norma UNE 12464.1) REQUISITOS DE ILUMINAÇÃO SEGUNDO A ATIVIDADE (Norma UNE 12464.1)

Edificios educativos / Edifícios escolares

ACTIVIDAD	Em (lux)	UGR	Ra
Aulas, aulas de teoría Aulas, aulas teóricas	300	19	80
Aulas para clases nocturnas Salas para aulas nocturnas	500	19	80
Sala de lectura Sala de leitura	500	19	80
Pizarra / Quadro	500	19	80

Bibliotecas / Bibliotecas

ACTIVIDAD	Em (lux)	UGR	Ra
Estanterías / Prateleiras	200	19	80
Áreas de lectura Área de leitura	500	19	80
Puestos de servicio al público Postos de serviço ao público	500	19	80

Oficinas / Escritórios

ACTIVIDAD	Em (lux)	UGR	Ra
Escritura, lectura, tratamiento de datos Escrita, leitura, tratamento de dados	500	19	80
Dibujo técnico Desenho técnico	750	16	80
Puestos de trabajo CAD Postos de trabalho CAD	500	19	80
Salas de reuniones Salas de reuniões	500	19	80
Mostrador de recepción Balcão de recepção	300	22	80
Archivos / Arquivos	200	25	80

Restaurantes / Restaurantes

ACTIVIDAD	Em (lux)	UGR	Ra
Recepción, caja, buffet Recepção, caixa, bufete	300	22	80
Cocinas / Cozinhas	500	22	80
Pasillos / Corredores	100	25	80

REQUISITOS DE ILUMINACIÓN PARA INSTALACIONES DEPORTIVAS (Norma UNE 12193) REQUISITOS DE ILUMINAÇÃO PARA INSTALAÇÕES DESPORTIVAS (Norma UNE 12193)

	ACTIVIDAD	CLASE III		CLASE II		CLASE I	
		Em (lux)	Uniformidad (Emin/Em)	Em (lux)	Uniformidad (Emin/Em)	Em (lux)	Uniformidad (Emin/Em)
INTERIOR	Pádel / Pádel	300	0,5	500	0,7	750	0,7
	Tenis / Ténis	300	0,6	500	0,7	750	0,7
	Natación / Natação	300	0,5	500	0,7	750	0,7
	Fútbol (5/6) / Futebol (5/6)	200	0,5	500	0,5	750	0,7
	Baloncesto / Basquetebol	200	0,5	500	0,5	750	0,7
	Voleibol / Voleibol	200	0,5	500	0,5	750	0,7
	Judo / Judo	200	0,5	500	0,5	750	0,7
Karate / Karaté	200	0,5	500	0,5	750	0,7	
EXTERIOR	Pádel / Pádel	200	0,6	300	0,7	500	0,7
	Tenis / Ténis	200	0,6	300	0,7	500	0,7
	Natación / Natação	200	0,5	300	0,7	500	0,7
	Fútbol (5/6) / Futebol (5/6)	75	0,5	200	0,6	500	0,7
	Baloncesto / Basquetebol	75	0,5	200	0,6	500	0,7
Voleibol / Voleibol	75	0,5	200	0,6	500	0,7	

CLASE I / TIPO I

Competición internacional y nacional.
Entrenamiento de muy alto nivel.
Competição internacional e nacional.
Treino de muito alto nível.

CLASE II / TIPO II

Competición regional o de club local.
Entrenamiento de alto nivel.
Competição regional ou de clube local.
Treino de alto nível.

CLASE III / TIPO III

Competición local sin espectadores. Entrenamiento general, colegios y actividades recreativas.
Competição internacional e nacional.
Treino de muito alto nível.

CONCEPTOS TÉCNICOS BÁSICOS DE ILUMINACIÓN.

CONCEITOS TÉCNICOS BÁSICOS DE ILUMINAÇÃO.



CCT Temperatura de color correlacionada

Es la sensación de color que percibe el ojo humano ante una luz. En el caso de los cálidos predomina el ámbar y en los fríos predomina el azul. Se mide en grados Kelvin (K) y está relacionada con la temperatura a la que el cuerpo negro, al calentarse, presenta una apariencia de color similar.

CCT Temperatura de cor correlacionada

Sensação de cor que o olho humano percebe perante a luz. No caso dos quentes predomina o vermelho e nos frios o azul. É medido em K (Kelvin).



CRI Índice de reproducción cromática

Mide, en una escala de 0 a 100, la capacidad que tiene una fuente luminosa para reproducir fielmente los colores de un objeto, en comparación con una fuente de luz natural o real (Sol).

90$Ra \le 100$ Muy eficiente: indoor especiales

80$Ra \le 90$ Eficiente: indoor

70$Ra \le 80$ Regular: outdoor

Ra<70 Deficiente: no usual en LED

CRI Índice de reprodução cromática

Mede, numa escala de 0 a 100, a capacidade da fonte de luz reproduzir fielmente as cores de um objeto, em comparação com uma fonte de luz natural ou real (Sol).

90$Ra \le 100$ Muito eficiente: interiores especiais

80$Ra \le 90$ Eficiente: interior

70$Ra \le 80$ Regular: exterior

Ra<70 Deficiente: não usual em LED

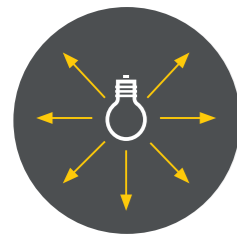

Flujo luminoso

Se mide en lúmenes (lm) y es la potencia emitida por la fuente luminosa, en todas las direcciones del espacio, en forma de radiación luminosa sensible al ojo humano.

Fluxo luminoso

Medido em lúmens (lm), é a potência emitida pela fonte de luz, em todas as direções do espaço, na forma de radiação de luz sensível ao olho humano.

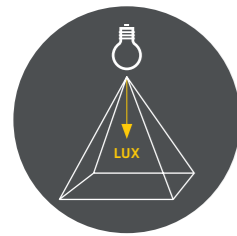

Iluminancia

Se mide en lux (lm/m²) y es la densidad de luz sobre una superficie, es decir, mide la cantidad de flujo luminoso por unidad de superficie.

Iluminância

Mede-se em lux (lm/m²) e é a densidade da luz numa superfície, ou seja, mede a quantidade de fluxo luminoso por unidade de área.



Flicker

Se trata de un fenómeno ligado a variaciones rápidas de la corriente eléctrica que alimenta a los LED. Estas variaciones se producen por una mala rectificación de la energía alterna de entrada del driver.

Si el driver presenta un porcentaje alto de flicker, produce irritación, distracción y problemas de salud como dolores de cabeza e incluso crisis epilépticas en las personas expuestas a las luminarias.

Con un nivel de flicker reducido o inexistente, se garantiza un confort visual que potencia la seguridad y la productividad laboral.

Flicker

É um fenómeno ligado às rápidas variações da corrente elétrica que alimenta os LEDs. Estas variações são causadas por uma má correção da entrada de energia alternada do driver.

A alta percentagem de flicker causa irritação, distração e problemas de saúde, como dores de cabeça e até convulsões epilépticas em pessoas expostas às luzes.

Com um nível de flicker reduzido ou inexistente, o conforto visual é garantido, o que aumenta a segurança e a produtividade do trabalho.

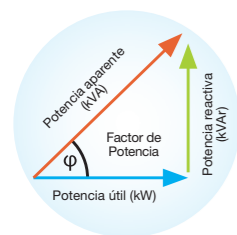

Factor de potencia

Mide la eficiencia de consumo eléctrico a la hora de convertir este consumo en energía útil; en el caso que nos ocupa, en luz.

FP=Potencia real de trabajo/Potencia total consumida
Cuanto más próximo sea el valor a 1, mejor FP.

Factor de potência

Mede a eficiência do consumo elétrico ao converter este consumo em energia útil, no nosso caso, em luz.
FP=Potência real de trabalho/Potência total consumida
Quanto mais próximo for o valor de 1, melhor FP.

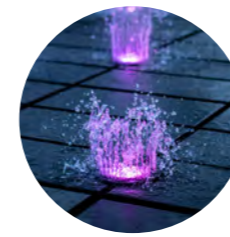

Grado IP

Indica los grados de protección proporcionados por la envolvente contra el acceso a las partes peligrosas de cuerpos sólidos extraños y de agua.

Todos estos códigos se encuentran descritos en una norma, en la que además se indica la forma de realizar los ensayos para su verificación:

UNE 20324, que es equivalente a la norma europea EN 60529.

Grau IP

Indica os graus de proteção fornecidos contra a intrusão a partes perigosas, contra a penetração de corpos sólidos estranhos e contra o contacto com água.

Todos esses códigos são descritos de forma padrão, que também indica de que forma se realizam os testes de verificação:

Código IP: UNE 20324, que é equivalente à norma europeia EN 60529.

IPXX

1^{er} N^o Protección contra objetos y polvo

1^{er} N^o Proteção contra objetos e poeiras

- 0 Sin protección. Sem proteção.
- 1 Protección contra objetos con un diámetro mayor a 50 mm. Proteção contra objetos de diâmetro superior a 50 mm.
- 2 Protección contra objetos con un diámetro mayor a 12 mm. Proteção contra objetos de diâmetro superior a 12 mm.
- 3 Protección contra objetos con un diámetro mayor a 2,5 mm. Proteção contra objetos de diâmetro superior a 2,5 mm.
- 4 Protección contra objetos con un diámetro mayor a 1 mm. Proteção contra objetos de diâmetro superior a 1 mm.
- 5 Protección contra el polvo. Proteção contra poeiras.
- 6 Estanca al polvo. À prova de pó.

IPXX

2^{do} N^o Protección contra líquidos

2^o N^o Proteção contra líquidos

- 0 Sin protección. Sem proteção.
- 1 Protección contra gotas de agua. Proteção contra salpicos.
- 2 Protección contra el goteo de agua con una inclinación de 15°. Proteção contra salpicos de água quando inclinado até 15°.
- 3 Protección contra pulverización. Proteção contra água pulverizada.
- 4 Protección contra salpicaduras. Proteção contra salpicos de água.
- 5 Protección contra los chorros de agua. Proteção contra jatos de água de baixa pressão.
- 6 Protección contra fuertes chorros de agua. Proteção contra jatos de água potentes.
- 7 Protección contra la inmersión durante un tiempo determinado. Proteção contra imersão por um certo tempo.
- 8 Protegida contra la inmersión prolongada. Proteção contra imersão prolongada.



Eficiencia

Relación entre la cantidad de luz emitida (lm) y la potencia (W) consumida para hacerlo, por eso su unidad de medida es lm/W. El objetivo es conseguir los valores más altos posibles.

Eficiência

Relação entre a quantidade de luz emitida (lm) e a potência (W) consumida para fazê-lo, por isso, a unidade de medida é lm/W. O objetivo é alcançar os maiores valores possíveis.

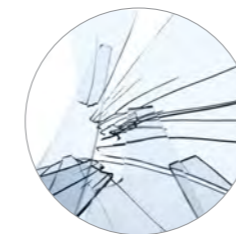

Grado IK

Indica el grado de protección proporcionado por la envolvente contra los impactos mecánicos nocivos, salvaguardando así los materiales o equipos en su interior.

Todos estos códigos se encuentran descritos en una norma, en la que además se indica la forma de realizar los ensayos para su verificación:

Norma UNE-EN 50102.

Grau IK

Indica o grau de proteção fornecido pelo invólucro aos impactos mecânicos prejudiciais, protegendo assim os materiais ou equipamentos internos.

Todos esses códigos são descritos de forma padrão que também indica como realizar os testes para verificação:

Norma UNE-EN 50102.

CÓDIGOS IK (EN 50102)	01	02	03	04	05	06	07	08	09	10
ALTURA (cm)	7,5	10	17	25	35	20	40	29,5	20	40
ENERGÍA DE IMPACTO (J)	0,15	0,20	0,35	0,50	0,70	1	2	5	10	20

CONTROLADORES TIRAS LED

CONTROLADORES FITAS LED

CORTE DE FASE

Regulación recortando parte de la onda sinusoidal de la tensión de red, en mayor o menor medida (1-100 %), sin necesidad de línea de control adicional. Se conecta el regulador en serie entre L alimentación y equipo.

Regulação cortando parte da onda senoidal da tensão da rede, em maior ou menor grau (1-100%), sem a necessidade de uma linha de controle adicional. O regulador é ligado em série entre a potência L e o equipamento.

0/1-10V

El sistema de regulación 0/1-10V requiere un regulador 0/1-10V adicional y se basa en la variación de la señal de salida, la cual permite la regulación del flujo lumínico entre 1 y 100%, todo ello a través de una señal analógica adicional de control, con polaridad +/- que hay que respetar.

El pulsador permite también la regulación del flujo lumínico de salida, el encendido y apagado conectándolo directamente al controlador.

O sistema de regulação 0/1-10V requer um regulador 0 / 1-10V adicional e é baseado na variação do sinal de saída, que permite a regulação do fluxo de luz entre 1 e 100%, tudo por meio de um sinal analógico adicional, com polaridade +/- que deve ser respeitado.

O controlador também permite a regulação do fluxo luminoso de saída e a sua ligação.

DALI

Sistema de regulación digital y direccionable, que permite la compatibilidad e intercambiabilidad entre equipos de distintos fabricantes.

Es un sistema bidireccional, con una estructura formada por un maestro: el controlador; y varios esclavos: drivers, controladores y sensores; los cuales ejecutan comandos y responden a las solicitudes.

No existe la necesidad de dispositivos mecánicos para el encendido, apagado y regulación, se realiza mediante comandos por la línea de control.

La comunicación dentro del sistema se lleva a cabo mediante un bus o línea de control de 2 hilos, sin polaridad y sin necesidad de cables especiales apantallados, por lo que el cableado puede ser conjunto: línea alimentación + bus DALI (5 hilos).

El direccionamiento de cada uno de los componentes se realiza vía software:

- Hasta 64 drivers/controladores, individualmente.

- Hasta 16 drivers/controladores en grupos.

- Todos simultáneos mediante el comando "broadcast".

Sistema de regulação digital e direccionável que permite compatibilidade e intercambiabilidade entre equipamentos de diferentes fabricantes.

É um sistema bidireccional, com estrutura formado por um elemento principal: o controlador; e os seus elementos dependentes: drivers, controladores e sensores. Estes executam os comandos e respondem as suas solicitações.

Não há necessidade de dispositivos mecânicos para ligar, desligar e regular, realizando-se todo o controle por comando.

A comunicação dentro do sistema ocorre realizado por linha de 2 fios, sem polaridade e sem necessidade de cabos especiais, de modo que a fiação pode ser definido: linha de energia + DALI (5 fios).

A direção de cada um dos componentes é feito via software:

- Até 64 drivers / controladores, individualmente.

- Até 16 drivers / controladores em grupos.

- Tudo simultâneo por transmissão.

PARED

Controladores táctiles con salidas específicas para el tipo de tira LED deseado, que se instala en las cajas de mecanismos convencionales de la pared y permite regular la intensidad y el color adecuado, guardar configuraciones específicas para su posterior selección, y selección de modos dinámicos.

Controladores tácteis com saídas específicas para o tipo de tira LED deseado, que se instalam em caixas de mecanismos convencionais na parede e que permitem regular a intensidade e a cor pretendida, salvar configurações específicas para utilização posterior e para seleção de modos dinâmicos.

PARED + MANDO RF

Controlador táctil de pared como el modelo anterior, que incluye un mando RF para controlar la tira desde ambos dispositivos: mando a distancia o controlador en la pared.

Controlador táctil montado na parede como o modelo acima, que inclui um comando por RF para controlar a fita de ambos os dispositivos: controle remoto ou comando na parede.

MANDO RF

Controladores vía mando RF con salidas específicas para el tipo de tira LED deseado, que permite regular la intensidad y el color adecuado y seleccionar modos dinámicos.

Comandos por RF com saídas específicas para o tipo de fita LED deseada, que permitem regular a intensidade e a cor mais adequada e seleccionar modos dinâmicos.

MANDO MULTIZONA RF

Solución que permite controlar, con un mismo mando, hasta 4 zonas distintas, con un controlador distinto en cada una de ellas. Tanto el mando como los controladores son específicos para el tipo de tira LED deseado, y permite regular la intensidad y el color adecuado y seleccionar modos dinámicos, de una zona en concreto o de varias a la vez.

Solução que permite controlar, com o mesmo comando, até 4 zonas diferentes, com um controlador diferente em cada uma delas. O comando e os controladores são específicos para o tipo de faixa LED deseada e permitem regular a intensidade, encontrar a cor mais apropriada e seleccionar modos dinâmicos de uma área específica ou de várias ao mesmo tempo.

DMX

DMX (Digital MultipleX) es un protocolo electrónico utilizado para gestión y control de iluminación profesional. Se suele utilizar para iluminación arquitectónica, de stands, escenarios y platós de televisión.

El protocolo DMX512 se basa en la utilización de "canales" para transmitir órdenes de control a los equipos de la instalación, teniendo un límite de 512 canales por universo. Así mismo, cada canal se puede regular desde el valor 0 hasta el valor 255.

En una instalación con tira LED, cada canal controlará un color; es decir, para tira monocolor se requiere 1 canal, para bicolor 2 canales, para RGB 3 canales y para RGB+W 4 canales.

Estos canales se controlan desde mesa de mezclas o a través de software específico.

DMX (Digital MultipleX) é um protocolo eletrônico usado para gerir e controlar iluminação profissional. É geralmente utilizado para iluminação arquitetônica, exposições, palcos e aparelhos de televisão.

O protocolo DMX512 é baseado no uso de "canais" para transmitir ordens para controlar o equipamento instalado, tendo um limite de 512 canais por universo. Da mesma forma, cada canal pode ser regulado de 0 a 255.

Numa instalação com uma tira LED, cada canal controlará uma cor, isto é, para uma fita de cor única é necessário 1 canal, para uma de duas cores serão necessários 2 canais, para RGB 3 canais e para RGB + W 4 canais.

Esses canais são controlados a partir através de um software específico.

SLESA

Solución de interfaces y software específico para control DMX de instalaciones de iluminación.

Permiten la posibilidad, a través de un PC, de implementar escenas específicas, programación temporal de las mismas, control local o en remoto de la instalación vía internet.

Solução de interface e software específico para o controle DMX de instalações de iluminação.

Permitem a possibilidade, por meio de um PC, de implementar

cenários específicos, programar temporariamente os mesmos e controlar local ou remotamente a instalação via Internet.

CASAMBI

CASAMBI es un sistema inalámbrico que crea la propia red entre los dispositivos conectados para poder retransmitir las señales a cualquier dispositivo de la red aunque no esté cerca del punto desde donde se manda la señal. Aparte del control local, puede llevarse a cabo un control en remoto de la instalación a través de un Gateway conectado a Internet.

Este controlador cuenta con 4 canales de salida PWM independientes, que se pueden configurar para control de tira monocolor, bicolor, RGB ó RGBW.

Una red Casambi admite hasta 250 dispositivos y podemos integrar ilimitadas redes CASAMBI.

CASAMBI é um sistema sem fios que cria sua própria rede entre dispositivos conectados, sendo capaz de retransmitir os sinais para qualquer dispositivo na rede, mesmo que não se encontre perto do emissor/receptor de sinal. Além do controle local, o controle remoto pode ser realizado através da instalação através de um gateway conectado à Internet.

Este controlador possui 4 canais de saída PWM independentes, que podem ser configurados para controlar tiras monocolor, bicolor, RGB ou RGBW.

Uma rede Casambi suporta até 250 dispositivos e podem-se integrar infinitas Redes CASAMBI.

SMART HOME

Controladores que compaginan la red WiFi y la tecnología Bluetooth para manejar la instalación desde nuestro dispositivo móvil.

Permiten el manejo de la instalación a través de Alexa y Google Home.

Aportan un control absoluto, automatizado y no presencial de la iluminación, operando cómodamente y ejecutando las órdenes desde la APP del Smartphone o con mandos a distancia.

Drivers que combinan a rede WiFi e a tecnologia Bluetooth para gerir a instalação desde um dispositivo móvel.

A gestão da instalação poderá ser feita através da Alexa e do Google Home.

Fornecem um controlo absoluto e automatizado do sistema de iluminação, executando as ordens de forma confortável a partir de um smartphone ou com comando à distância

TIRAS DIGITALES

Controladores específicos para tira LED digital, donde se controlará de forma independiente cada tramo mínimo de la tira, ofreciendo distintas opciones de cambio de color (flash, barridos, etc.) y velocidad.

Drivers específicos para tiras LED digitais, que serão controladas de forma independente cada seção mínima da fita, oferecendo diferentes opções para mudar a cor (flash, varreduras, etc.) e velocidade.

AMPLIFICADORES

Una instalación de tira LED puede requerir una longitud de tira mayor de 10 metros (máximo que debe conectarse de forma continua) o una cantidad de tira que consuma más potencia de la permitida por el controlador seleccionado.

Mediante el uso de amplificadores esto no será un problema, pudiendo instalar todos los metros deseados bajo el mismo controlador consiguiendo la total uniformidad de la instalación.

Uma instalação fitas LED pode exigir um comprimento da tira superior a 10 metros (máximo que deve ser conectado de forma contínua) ou uma quantidade de fita que consume mais potência do que a permitida pelo controlador selecionado.

Ao usar amplificadores isso não será um problema. Poderá ligar todos os amplificadores desejados ao mesmo controlador, alcançando uma uniformidade total da instalação.

OPCIONES ESPECÍFICAS PARA REGULACIÓN VIAL

OPÇÕES ESPECÍFICAS PARA REGULAÇÃO VIAL

DN2-

DOBLE NIVEL SIN LÍNEA DE MANDO

El *driver* se programa para disminuir el flujo a un nivel inferior, a partir de un determinado momento. El porcentaje de reducción, así como las horas en las que se produce, son totalmente configurables en THREELINE, a petición del cliente. Este puede especificar los valores que necesita, si no, se le aplicará una configuración estándar. No se necesita cable de control en la instalación.

DN2+

DOBLE NIVEL CON LÍNEA DE MANDO

Regulación en dos niveles con línea de mando:

- En el estado inicial o reposo, la luminaria se enciende a un porcentaje predefinido (ej. 30%). En la entrada de control la señal será 0 Vac.

- El cambio de nivel al 100 % se realiza con una señal de 230 Vac en la línea de control.

Ejemplo de uso: zonas con control de presencia. Sin presencia, la línea de control tiene una señal de 0 Vac y se ilumina al porcentaje seleccionado (ej. 30 %); al detectar presencia, la línea de control tiene una señal de 230 Vac y se ilumina al 100 %.

DPR

PROGRAMABLE

Sistema autónomo en el que se pueden seleccionar hasta 8 niveles de salida referenciados al centro del tiempo de encendido. La programación se realiza en THREELINE.

Se pueden cargar hasta 3 programaciones distintas personalizadas según las necesidades del cliente y 4 ofrecidas por el fabricante del *driver*. En la instalación, el cliente puede cambiar desde cabecera de una programación a otra con una secuencia predeterminada de encendidos, que se realizan con la ayuda de un programador específico.

Ejemplo de uso: una curva de programación para el verano, otra para invierno y otra para Navidad porque, aunque es invierno, hay más vida nocturna.

DRC

REGULACIÓN EN CABECERA

Se regula el nivel de iluminación a través de la tensión de entrada. No es necesaria línea de control.

Variando la tensión de entrada desde 192 a 250 Vac, se regula la luminaria de manera lineal.

Por debajo de 192 Vac se regula de manera autónoma y a más de 250 Vac se apaga para proteger la luminaria.

NÍVEL DUPLO SEM LINHA DE COMANDO

O *driver* está programado para diminuir o fluxo para um nível mais baixo, a partir de um determinado momento. A percentagem de redução, assim como as horas em que ocorre, são totalmente configuráveis nos equipamentos THREELINE, a pedido do cliente. Por isso, poderá especificar os valores que precisa, caso contrário será aplicada uma configuração padrão. Nenhum cabo de controlo é necessário na instalação.

NÍVEL DUPLO COM LINHA DE COMANDO

Regulação em dois níveis com linha de comando:

- No estado inicial ou em repouso, a luminária é ligada a uma percentagem pré-definida (por exemplo, 30%). Na entrada de controlo, o sinal será 0Vac.

- A mudança de nível para 100% é feita com um sinal 230Vac na linha de controlo.

Exemplos de aplicação: áreas com controlo de presença. Sem presença, a linha de controlo tem um sinal 0Vac e ilumina a percentagem seleccionada (por exemplo, 30%); ao detectar a presença, a linha de controlo tem sinal 230Vac e acende 100%.

PROGRAMÁVEL

Sistema autónomo no qual se podem seleccionar até 8 níveis de saída. A programação é feita pela THREELINE.

Podem ser carregados até 3 programas personalizados diferentes de acordo com as necessidades do cliente e 4 oferecidos pelo fabricante do *driver*. Na instalação, o cliente pode mudar do cabeçalho de uma programação a outra com uma sequência predeterminada de ignições, que são realizadas com a início de um programador específico.

Exemplo de utilização: uma curva de programação para o verão, outra para o inverno e outra para o Natal porque, embora seja inverno, há mais vida noturna.

REGULAÇÃO NA LUMINÁRIA

O nível de iluminação é regulado pela tensão de entrada. Nenhuma linha de controlo é necessária.

Variando a tensão de entrada de 192 para 250Vca, a luminária é regulada de forma linear.

Abaixo de 192Vac é regulado de forma autónoma e, a mais de 250Vac, desliga-se para proteger a luminária.

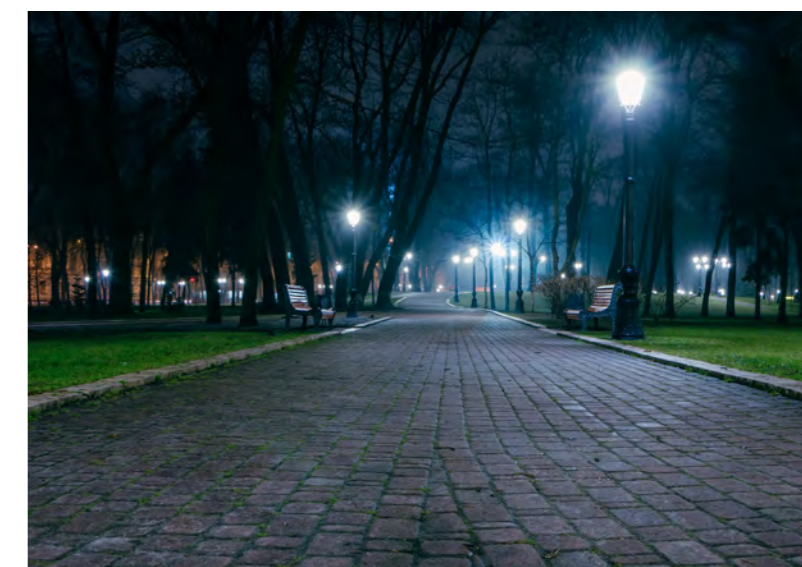



¿QUÉ ES CASAMBI?

Es un avanzado sistema de control basado en Bluetooth Low Energy (BLE). Casambi es una aplicación inalámbrica avanzada y la única de bajo consumo disponible en todos los nuevos smartphones, tablets y hasta smartwatches, desde 2012.

La tecnología Casambi se puede integrar en luminarias y drivers proporcionando una solución óptima para lograr una fácil instalación y funcionalidad con un mínimo coste.

Este sistema proporciona una red de malla donde se encuentra toda la inteligencia replicada en cada nodo.

O QUE É CASAMBI?

É um sistema de controlo avançado baseado em Bluetooth Low Energy (BLE). Casambi é uma solução sem fios e a única de baixo consumo de energia disponível em todos os novos smartphones, tablets e até smartwatches, desde 2012.

A aplicação Casambi pode ser integrada em luminárias e drivers, fornecendo uma solução em termos de instalação e funcionalidade fáceis, a baixo custo.

Esse sistema fornece uma rede em malha na qual se aloja toda a inteligência replicada.

FÁCIL DE USAR

La solución Casambi es un sistema muy intuitivo diseñado tanto para el usuario particular como para el mercado profesional.

La descarga de la APP es gratuita y se encuentra disponible en Google play y App Store.

Conéctalo a la luminaria, empareja con tu teléfono y listo, sin necesidad de ser configurado por un profesional.

FÁCIL DE USAR

A aplicação Casambi é um sistema muito intuitivo, desenhado tanto para o usuário particular, como para o mercado profissional.

Faça o download da APP. É gratuita e está disponível no Google Play e na App Store.

Ligue a luminária, emparelhe com o seu equipamento e está pronto a usar, sem necessitar de configuração profissional.

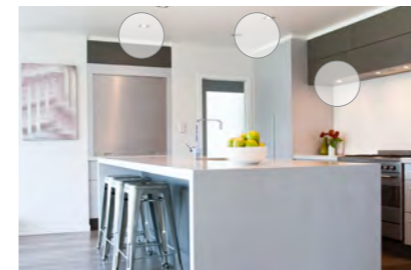

CARACTERÍSTICAS

1. Compatible con todos los nuevos smartphones, tablets y smartwatches.
2. El sistema está en constante sincronización.
3. Se conecta solamente cuando es necesario.
4. Permite hasta 250 dispositivos en una red.
5. Número ilimitado de escenas y animaciones.
6. Diferentes niveles de acceso.
7. Versatilidad en el cambio de configuración de la instalación.
8. Alcance máximo entre nodos: 30m (dependiendo de obstáculos).

CARACTERÍSTICAS

1. Compatível com todos os novos smartphones, tablets e smartwatches.
2. O sistema está em sincronização constante.
3. Liga-se apenas quando é necessário.
4. Até 250 dispositivos numa rede.
5. Número ilimitado de cenários e animações.
6. Diferentes níveis de acesso.
7. Versatilidade na alteração da configuração de instalação.
8. Alcance máximo entre nós: 30m (dependendo dos obstáculos).

FUNCIONES

- Atenuar la iluminación y ajustar la temperatura de color.
- Agrupar las luminarias y encender, apagar y atenuar en conjunto o individualmente.
- Configurar, guardar y recuperar escenas y animaciones.
- Utilizar el temporizador para activar y desactivar escenas o animaciones basadas en la hora y la fecha.
- Tomar fotografías de tus espacios y agregar control de iluminación directamente sobre ellas.
- Ajustar los temporizadores en función del amanecer y el atardecer.

FUNÇÕES

- Diminui a iluminação e ajusta a temperatura da cor.
- Agrupe as lâmpadas e acenda, desligue e reduza a iluminação do conjunto ou individualmente.
- Configure, guarde e recupere cenários e animações.
- Use o temporizador para ativar e desativar cenários ou animações de acordo com hora e data.
- Tire fotografias dos seus espaços e controle a iluminação diretamente
- Defina o temporizador para para o nascer e o pôr do sol.

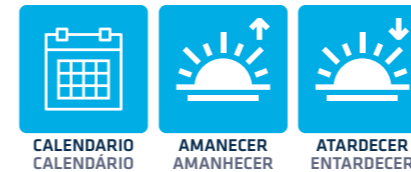

ACCESO LOCAL

No es necesario tener conexión a internet para su funcionamiento. La comunicación se realiza a través de BLE (Bluetooth Low Energy).

O seu funcionamento não requer ligação à internet. A ligação é feita por BLE (Bluetooth low energy).

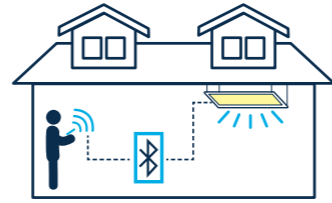

ACCESO REMOTO

Es posible controlar las luminarias a distancia a través de internet utilizando un "Gateway". Un administrador de la red puede también configurar remotamente la red.

É possível controlar as luminárias remotamente através de internet usando um "Gateway". Um administrador de rede também pode configurar remotamente a rede.

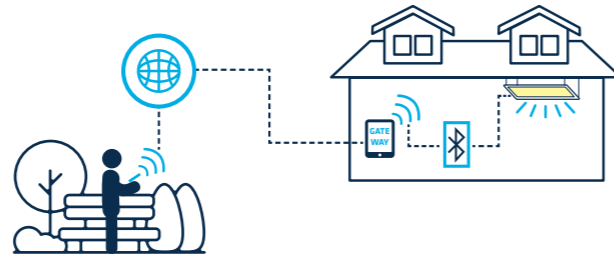

GATEWAY

Para el control remoto es necesario tener siempre conectado un smartphone o tablet con conexión a internet dentro del alcance BLE de alguna de las luminarias.

Para controlar remotamente, é sempre necessário conectar um smartphone ou tablet com ligação à Internet dentro da gama BLE de qualquer uma das luminárias.

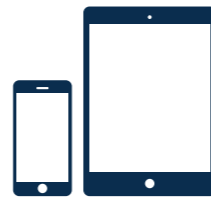

DISPOSITIVOS / DISPOSITIVOS



REGULACIÓN DE LUMINARIAS MEDIANTE CASAMBI

REGULAÇÃO DE LUMINÁRIAS COM CASAMBI

En los productos donde aparezca este símbolo, es porque se puede cambiar el driver original del producto por un driver compatible con Casambi.

A presença deste símbolo junto dos produtos significa que se pode alterar o driver original por um driver compatível com Casambi.

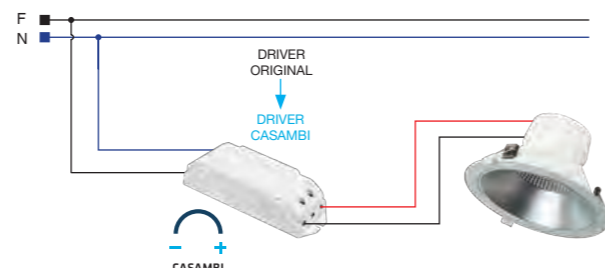

¿QUÉ ES SMART HOME?

Smart Home (hogar inteligente) es el que incorpora un sistema que permite automatizar tareas. El objetivo principal es mejorar la vida de las personas y favorecer un uso eficiente de los recursos, lo que reduce tanto el gasto particular como los propios recursos.

La iluminación inteligente del hogar (Smart Lighting) incorpora muchas tecnologías para que las tiras LED tanto de interior como de exterior funcionen automáticamente bajo ciertas condiciones. El control se puede realizar tanto de forma presencial como en remoto gracias a los smartphones y la conexión a internet.

Sus principales ventajas son la gestión de la iluminación del hogar a distancia, el ahorro de energía y el aumento de la eficiencia de los dispositivos.

FÁCIL DE USAR

Smart Home es un sistema intuitivo y muy sencillo diseñado para su uso en el hogar. Se gestiona mediante una APP descargable gratuita.

Se conecta a las tiras LED, se sincroniza con el teléfono y no necesita ser configurado por un profesional.

FUNCIONES

- Encender y apagar en remoto
- Control por voz
- Programar el encendido y apagado
- Regular la intensidad y tono de la luz
- Configurar diferentes ambientes en cada lugar de la casa
- Iluminar automáticamente
- Sincronizar la música con la luz

O QUE É SMART HOME?

Uma casa inteligente incorpora um sistema que permite automatizar tarefas. O objetivo principal é melhorar a vida das pessoas e promover um uso eficiente dos recursos, o que reduz tanto os gastos particulares, como o consumo dos próprios recursos.

A iluminação doméstica inteligente incorpora muitas tecnologias para que as fitas LED, tanto de interior como exterior, funcionem automaticamente de acordo com algumas condições. O controlo pode ser feito tanto no local como remotamente, graças ao uso de smartphones com ligação à internet.

As suas principais vantagens são a gestão do sistema de iluminação do lar à distância, economizando energia e aumentando a eficiência dos dispositivos.

FÁCIL DE USAR

Smart Home é um sistema intuitivo e muito simples, projetado para uso doméstico. É gerido através de uma APP cujo download é gratuito.

Conectam-se as fitas LED, sincroniza-se com o telefone e não requer assistência de profissional.

FUNÇÕES

- Ligar e desligar remotamente
- Controlar por voz
- Programar horários de funcionamento
- Regular a intensidade e o tom da luz
- Configurar cenários diferentes em cada lugar da casa
- Iluminar automaticamente
- Sincronizar música com luz

HUMAN CENTRIC LIGHTING (HCL)



Los ritmos circadianos regulan los cambios en las características físicas y mentales que ocurren en el transcurso de un día en el ser humano. Responden a la luz y oscuridad del ambiente en que se desenvuelve un organismo, ejemplo de ello es el dormir por la noche y estar despierto durante el día.

Tu cuerpo se mueve al ritmo de la luz, por ello es muy importante adaptar la luz artificial a estos ciclos consiguiendo un equilibrio entre la productividad y la relajación acorde al espacio.

Mediante protocolos de gestión de la iluminación, es posible simular en un espacio cerrado el ciclo circadiano de la luz (variación en la temperatura de color de la luminaria) y por tanto, mejorar la calidad de vida. Tiene muchos beneficios como, por ejemplo; un potencial de aumento de la productividad, un efecto positivo en la calidad del sueño, reducir el estrés, el insomnio, la depresión y algunas enfermedades.

El cambio de tonalidad de la luminaria manualmente se consigue a través de un Switch en una zona del producto poco visible, para mantener la belleza el dispositivo una vez instalado.

Pero existe la opción, en algunos de nuestros productos, para la cual este cambio se realiza a través de una aplicación, pudiendo conseguir, que la luminaria se convierta en un producto con característica **HCL: Human Centric Lighting**, concepto orientado al bienestar de las personas vinculado a la iluminación de los espacios.

Os ritmos circadianos regulam as mudanças nas características físicas e mentais que ocorrem ao longo do dia. Estes respondem à luz e à escuridão do ambiente em que um organismo se desenvolve, um exemplo disso é dormir à noite e ficar acordado durante o dia.

O seu corpo move-se ao ritmo da luz, pelo que é muito importante adaptar a luz artificial a estes ciclos, conseguindo um equilíbrio entre produtividade e descontração consoante o espaço.

Através de protocolos de gestão da iluminação é possível simular o ciclo circadiano da luz num espaço fechado (variação da temperatura de cor da luminária) e assim melhorar a qualidade de vida. Isto possui diversos benefícios como: um potencial aumento a produtividade, um efeito positivo na qualidade do sono, redução dos níveis de stress, insónia, depressão e outras doenças.

A mudança manual da tonalidade do luminária é realizada através de um Switch numa área discreta do produto, para manter a beleza do aparelho depois de instalado.

Mas, em alguns casos, existe a opção de realizar esta alteração através de uma aplicação, podendo conseguir que a luminária se transforme num produto com a característica **HCL (Human Centric Lighting)**, um conceito orientado para o bem-estar das pessoas ligada à iluminação dos espaços.

CCT SWITCH / CCT SWITCH

Las siglas CCT miden la temperatura de color correlacionada que emite la luminaria, que con los nuevos selectores de color: **CCT SWITCH**, se consigue unificar en un mismo producto tonos dentro de una misma luminaria.

El cambio del CCT que hemos desarrollado en las placas, está diseñado para que en ningún momento exista pérdida de flujo luminoso, tampoco pérdida de CRI y proporcione una mejora del SDCM, Standard Deviation Colour Matching, consiguiendo de esta manera tonos de luz muy confortables a la vista, independientemente de la tonalidad seleccionada de la luminaria.

Este gran avance, favorece a la reducción de espacio de almacenaje de mercancías, ya que en un mismo producto el cliente decidirá la elección de tonalidad deseada, sin necesidad de disponer de tres productos distintos.

A sigla CCT mede a temperatura de cor correlacionada emitida pela luminária. Com os novos seletores de cores **CCT SWITCH** é possível unificar tons dentro da mesma luminária.

A alteração do CCT que desenvolvemos nas placas é pensada para que não haja perda de fluxo luminoso, nem perda de CRI, em nenhum momento, proporcionando um aumento de SDCM, Standard Deviation Color Matching, e conseguindo assim tons claros muito confortáveis, independentemente da tonalidade da luminária selecionada.

Esse grande avanço favorece a redução do espaço de armazenamento da mercadoria, pois no mesmo produto o cliente decidirá a escolha da tonalidade desejada, sem a necessidade de ter três produtos diferentes.

DOMÓTICA / DOMÓTICA

El control de los equipos y la interconexión entre los mismos es cada vez más demandado por los usuarios. Buscan domotizar sus hogares o negocios mediante diferentes tecnologías de comunicación y regulación. Así mismo, este tipo de controles, están muy relacionados con el concepto HCL, ya que para alcanzar sus objetivos requiere del empleo de control de la luminaria, especialmente, para sistemas de control inalámbricos.

O controlo dos equipamentos e a interligação entre eles é cada vez mais exigido pelos usuários que procuram automatizar as suas casas ou empresas por meio de diferentes tecnologias de comunicação e regulação.

Da mesma forma, esses tipos de controles estão intimamente relacionados ao conceito HCL, pois para atingir estes objetivos é necessário controlar as luminárias, especialmente através de sistemas de controlo sem fio.



AHORRO ENERGÉTICO / POUPANÇA DE ENERGIA

Ya conocemos la tendencia del mercado a la domotización, que además de favorecer el control sobre las luminarias, ofrece un ahorro energético vinculado a la iluminación de entre un 9% hasta un 30% en total. Ya que la iluminación de los hogares representa en torno al 5% del consumo eléctrico, elevándose notoriamente en el sector terciario.

Já conhecemos a tendência do mercado de domotização que, além de favorecer o controlo das luminárias, permite economizar a energia ligada à iluminação entre 9% e 30%, no total, uma vez que a iluminação doméstica representa cerca de 5% do consumo de eletricidade e aumenta notavelmente no setor terciário.

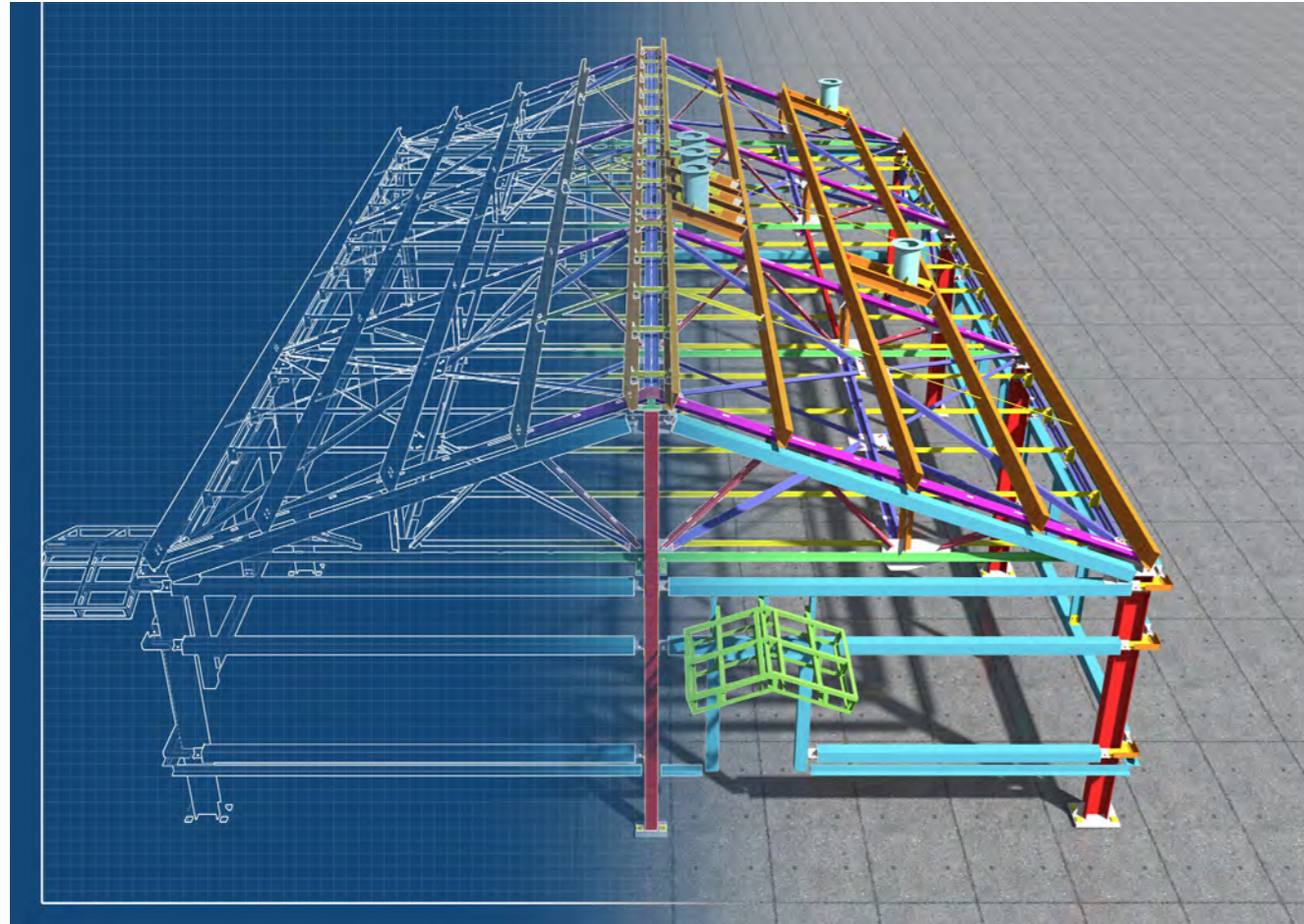

La metodología BIM (Building Information Modeling) es un sistema multidimensional que permite generar datos inteligentes que se pueden utilizar durante todo el ciclo de vida de un proyecto de construcción o de infraestructuras.

A través de esta metodología podemos obtener la información completa del edificio: geometría, relaciones espaciales, información geográfica, así como las cantidades y las características de sus componentes.

La utilización de este método respecto a los tradicionales, permite un trabajo colaborativo y multidisciplinar. El proyecto se gestiona de forma digital en un entorno común en el que pueden trabajar a la vez y en tiempo real los diferentes agentes implicados.

Gracias a que se centraliza toda la información del proyecto en un único modelo, se pueden detectar errores antes de llevarlo a cabo y realizar una mejor toma de decisiones, lo que llevara a una optimización de costes.

Threeline apuesta hacia el futuro y pone a tu disposición el conjunto de datos BIM para todas sus luminarias en formato Revit (aplicación BIM de Autodesk).

A metodologia BIM (Building Information Modeling) é um sistema multidimensional que gera dados inteligentes para serem utilizados durante todo o ciclo de vida de um projeto de construção ou infraestrutura.

Através desta metodologia podemos obter informações completas sobre o edifício, tais como: geometria, relações espaciais, informações geográficas, e ainda as quantidades e características dos seus componentes.

A utilização deste método permite um trabalho colaborativo e multidisciplinar. O projeto é gerido digitalmente num ambiente comum no qual os diferentes agentes envolvidos trabalham simultaneamente, e em tempo real.

Como todas as informações do projeto estão centralizadas num único modelo, é possível antecipar erros e tomar melhores decisões, o que permitirá a redução de custos.

A Threeline aposta no futuro e coloca à sua disposição o conjunto de dados BIM para todas as suas luminárias no formato Revit (aplicação Autodesk BIM).



PROYECTOS DE ILUMINACIÓN / PROJOTOS DE ILUMINAÇÃO



PROYECTOS DE ILUMINACIÓN / PROJOTOS DE ILUMINAÇÃO

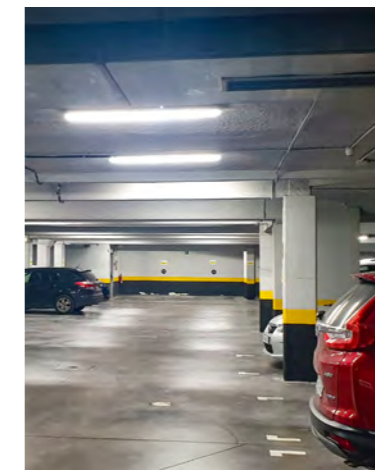
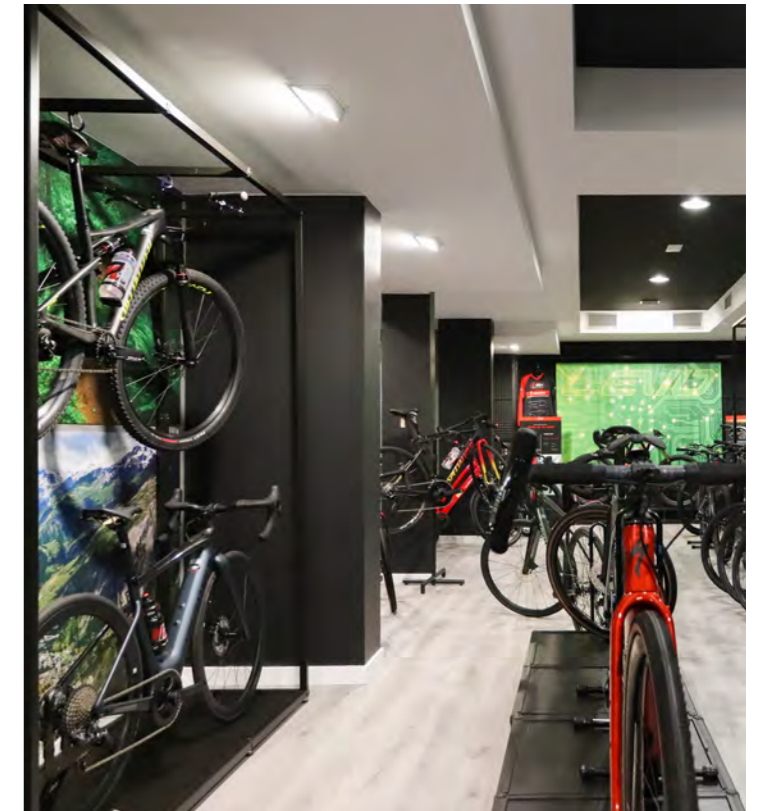

DOWNLIGHTS DOWNLIGHTS PLAFONES PLAFONS **PANELES PAINÉIS** LINEALES LINEARES LÁMPARAS LÂMPADAS TUBOS TUBOS

TRIPOLIS

P6060UGR / P30120UGR / P60120UGR

6000K 4000K 3000K 180-24Vdc 95/10-14V FLICKER FREE LOW UGR

CRI >80 cos φ >0.95 50,000 h ± 50,000

IP20 BL RAL 9016 DE 120°

• Material PS AL • Certif. CE ENAC CB

• Opc. de Reg. 0/1-10V DALI PUSH CASAMBI

• Opcional UE DRIVER IP44 KE 1.9W ON-OFF

• Accesorios

Modelo	CCT	W	W	lm	lm
P6060UGRBF	6000K	595x595x10 mm	40 W	5200 lm	4040 lm
P6060UGRBN	4000K	595x595x10 mm	40 W	5120 lm	4010 lm
P6060UGRBC	3000K	595x595x10 mm	40 W	4920 lm	3800 lm
P30120UGRBF	6000K	1195x295x10 mm	40 W	5200 lm	4040 lm
P30120UGRBN	4000K	1195x295x10 mm	40 W	5120 lm	4010 lm
P30120UGRBC	3000K	1195x295x10 mm	40 W	4920 lm	3800 lm
P60120UGRBF	6000K	1195x595x11 mm	50 W	6500 lm	5050 lm
P60120UGRBN	4000K	1195x595x11 mm	50 W	6400 lm	5010 lm
P60120UGRBC	3000K	1195x595x11 mm	50 W	6150 lm	4750 lm

THREELINE 65

Marca la zona exacta donde te encuentras en el catálogo. Dejando ver qué productos quedan por delante y cuáles has leído ya. Barra que representa a zona exata do catálogo onde se encontra para que possa facilmente visualizar que produtos se seguem e quais já foram lidos.

Separación por TIPOLOGÍA de producto en cada una de las clasificaciones generales. Divisão por TIPOLOGIA de produto em cada classificação geral.

Nombre de la familia. Nome da família.

Referencia raíz del producto. Referência original do produto.

Distintivo ECO, PRO, PREMIUM. Distintivo ECO, PRO, PREMIUM.

Pestaña que señala la CATEGORÍA de productos en la que nos encontramos. Separador que assinala a CATEGORIA dos produtos.

Características principales del producto. Características principais do produto.

Sello que remarca la característica distintiva del producto. Selo que destaca uma característica específica e distintiva do produto.

Opciones de regulación disponibles. Opções de regulação simples.

Opciones y complementos compatibles. Opções e complementos compatíveis.

Referencia del producto para la opción específica. Referência do produto para a opção específica.

Página donde se encuentran las referencias de dichas opciones. Página onde se encontram as referências para as respetivas opções.

Tabla de referencias. Tabela de referências

	Selector de CCT Seletor de CCT		Años de garantía Anos de garantia		Vidrio templado Vidro temperado		Ángulo Ângulo
	Control inteligente de CCT (HCL) Controlo de CCT inteligente (HCL)		V-in tensión de entrada V-in tensão de entrada		Polycarbonato opal Polycarbonato opal		Referencia Referência
	Selector de potencia Seletor de potência		Categoría de Producto ECO Categoria de Produto ECO		Aleación de Magnesio Liga de magnésio		Peso Peso
	Temperatura de color Temperatura da cor		Categoría de Producto PRO Categoria de Produto PRO		Poliestireno Poliestireno		Conector Ligador
	Vida Útil Vida Útil		Categoría de Producto PREMIUM Categoria de Produto PREMIUM		Polycarbonato PMMA Polycarbonato PMMA		Ancho máximo de tira Largura máxima da fita
	Número de conmutaciones Número de comutações		Acabado Acabamento		Polycarbonato microprismático Polycarbonato microprismático		Número de LEDs por metro Número de LEDs por metro
	Flicker Free Sem Flicker		Blanco Branco		Polycarbonato Polycarbonato		Corte mínimo Corte mínimo
	Índice UGR Índice UGR		Plata Prateado		Silicona Silicone		Tipo de LED Tipo de LED
	Índice de reproducción cromática Índice de reprodução cromática		Negro Preto		Vidrio + Polycarbonato Vidro + Polycarbonato		Empotrar Encastrar
	Grado de protección IP Grau de proteção IP		CRI>90 CRI>90		Radiofrecuencia Radiofrequência		Superficie Superfície
	Doble IP Duplo IP		Regulable Regulável		Bluetooth Bluetooth		Suspensión Suspensão
	Grado de protección contra Impactos Grau de proteção contra impactos		No regulable Não regulável		Kit emergencia Kit emergência		Tracklight Tracklight
	Driver Externo Driver Externo		Casambi Casambi		Sensor de luminosidad Sensor de luminosidade		Luminaria Luminária
	Driver Interno Driver Interno		Zigbee Zigbee		Sensor movimiento Sensor movimento		Recomendado Recomendado
	Factor potencia Factor potência		DALI DALI		Sensor movimiento interno Sensor movimento interno		Orientable Orientable
	Material bajo pedido Material sob pedido		DMX DMX		Sensor movimiento externo Sensor movimento externo		Frecuencia Frequência
	Clase I Classe I		Vidrio Vidro		Driver europeo Driver europeu		Potencia Potência
	Clase II Classe II		Aluminio Alumínio		Flujo luminoso real Fluxo luminoso real		Medidas Medidas
	Clase III Classe III		Acero inoxidable Aço inoxidável		Flujo luminoso nominal Fluxo luminoso nominal		Temperatura ambiente Temperatura ambiente

Tira LED Monocolor Fita LED Monocor

Tira LED Bicolor Fita LED Bicolor

Tira LED RGB Fita LED RGB

Tira LED RGB + W Fita LED RGB + W

Lineales Lineares

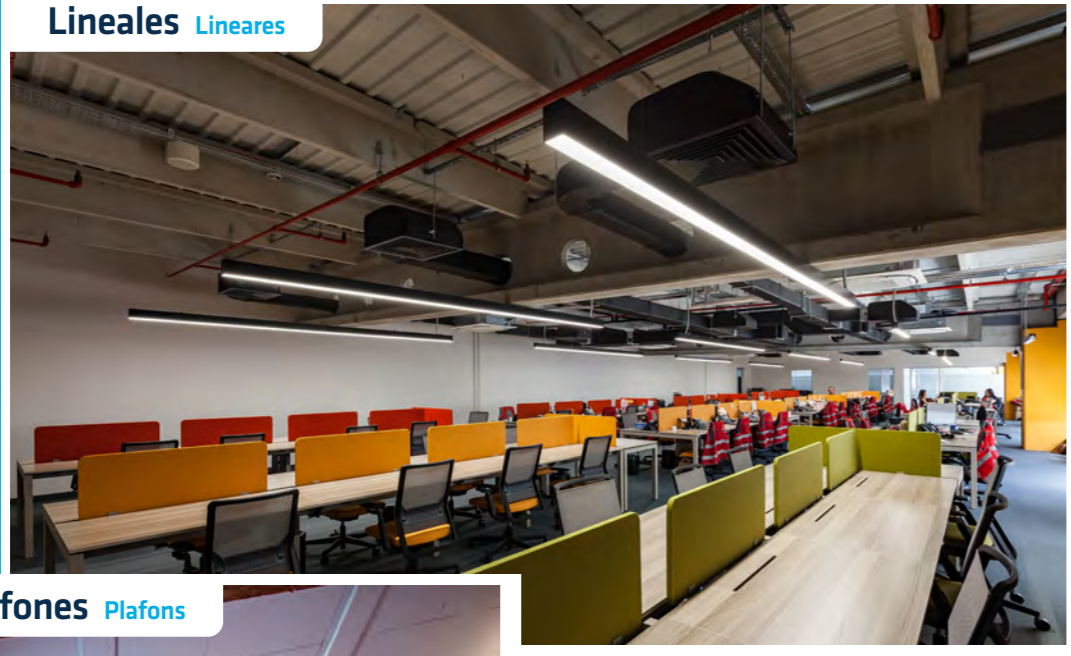

Downlights Downlights

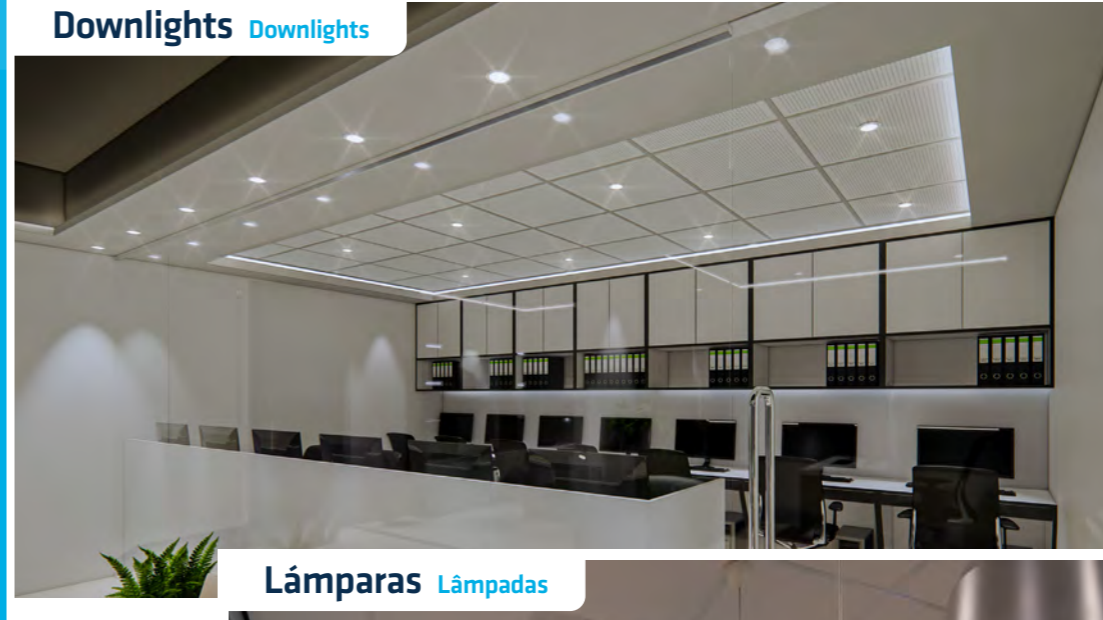

Plafones Plafons



Lámparas Lâmpadas



Paneles Painéis

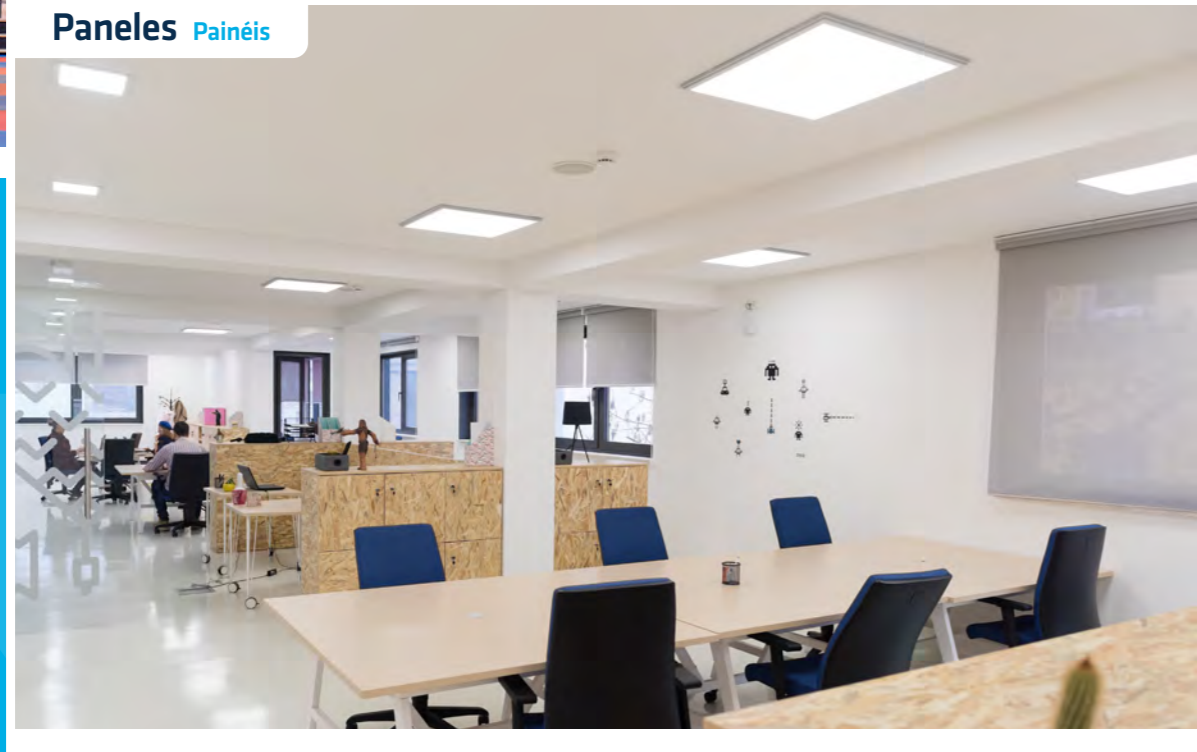

Tubos Tubos



INTERIOR

Downlight

Downlight



NEW **PRO** OREGON+



NEW **ECO** UTAH

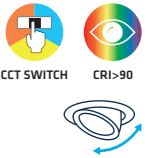

NEW **PRO** CALIFORNIA+



PRE-MIUM **NEW** BOSTON



NEW **ECO** MONTANA



PRO ALASKA



PRO NEVADA

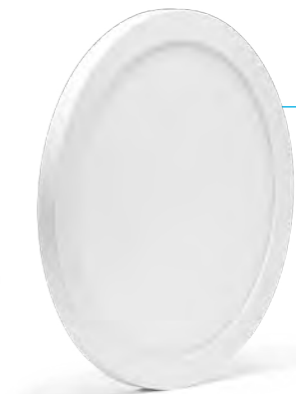
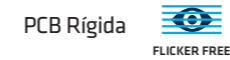

PRO MISURI



ECO MICHIGAN



ECO IRIS



OREGON+

PRO DLO40R / DLO60R

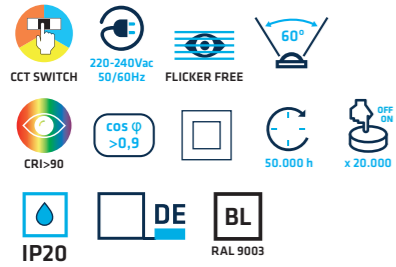

• Material



• Opc. de Reg.

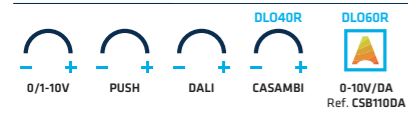

• Opcional



• Certif.



CCT SWITCH

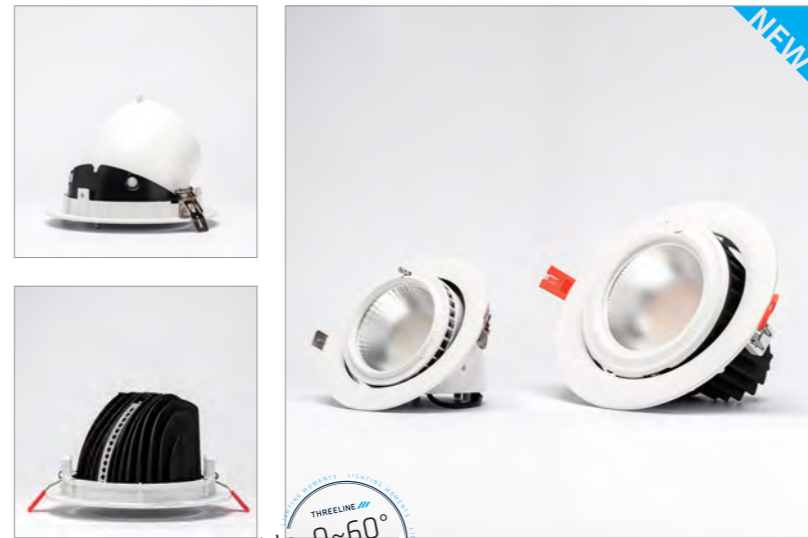

Orientable: 0~60°
Orientável: 0~60°
Rotación: 360°
Rotação: 360°

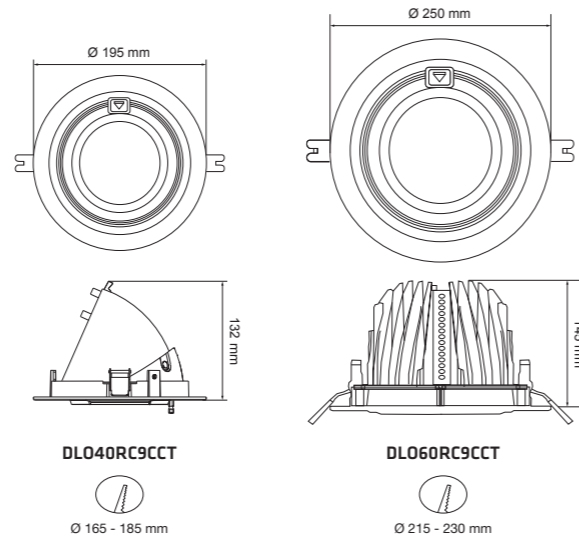

OPCIONES	W	CCT	5700K	4000K	3000K
DLO40RC9CCT *	38 W	5700K	5322 lm	4522 lm	4522 lm
		4000K	5322 lm	4522 lm	4522 lm
		3000K	4585 lm	3785 lm	3785 lm
DLO60RC9CCT *	60 W	5700K	6767 lm	5567 lm	5567 lm
		4000K	6767 lm	5567 lm	5567 lm
		3000K	6460 lm	5260 lm	5260 lm

* Opc. de Reg.

D1	0/1-10V, PUSH	D1	0/1-10V, PUSH
D2	DALI, PUSH	D2	DALI
D5	CASAMBI		

* Opcional

UE	UE DRIVER
E	KIT DE EMERGENCIA
S1	SENSOR MOVIMIENTO
S2	SENSOR LUMINOSIDAD

OREGON+

PRO DLO40C / DLO60C



• Material



• Opc. de Reg.



• Opcional



• Certif.



Orientable: 0~60°
Orientável: 0~60°

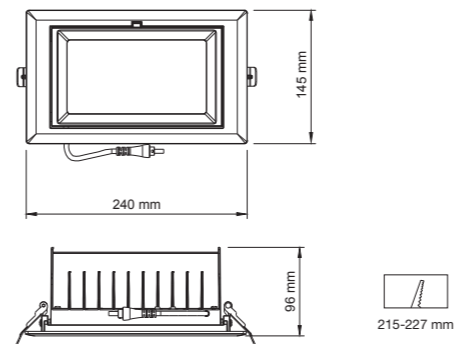

CCT SWITCH

OPCIONES	W	CCT	5700K	4000K	3000K
DLO40CC9CCT *	38 W	5700K	4616 lm	3816 lm	3816 lm
		4000K	4616 lm	3816 lm	3816 lm
		3000K	4093 lm	3293 lm	3293 lm
DLO60CC9CCT *	60 W	5700K	7700 lm	6500 lm	6500 lm
		4000K	7700 lm	6500 lm	6500 lm
		3000K	6831 lm	5631 lm	5631 lm

* Opc. de Reg.

D1	0/1-10V, PUSH	D1	0/1-10V, PUSH
D2	DALI, PUSH	D2	DALI
D5	CASAMBI		

* Opcional

UE	UE DRIVER
E	KIT DE EMERGENCIA
S1	SENSOR MOVIMIENTO
S2	SENSOR LUMINOSIDAD

UTAH

ECO DLU40RCCT

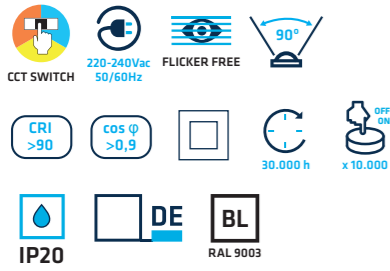

• Material



• Opc. de Reg.



• Opcional

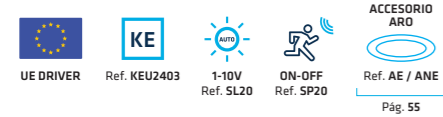

• Certif.



CCT SWITCH

OPCIONES	W	CCT	Beam	Beam
DLU40RCCT *	38 W	5700K	4706 lm	3906 lm
		4000K	4706 lm	3906 lm
		3000K	4163 lm	3368 lm

* Opc. de Reg.

DT 0/1-10V, DALI, PUSH
D5 CASAMBI

* Opcional

UE UE DRIVER S1 SENSOR MOVIMIENTO
E KIT DE EMERGENCIA S2 SENSOR LUMINOSIDAD



Orientable: 0~50°
Orientável: 0~50°
Rotación: 360°
Rotação: 360°

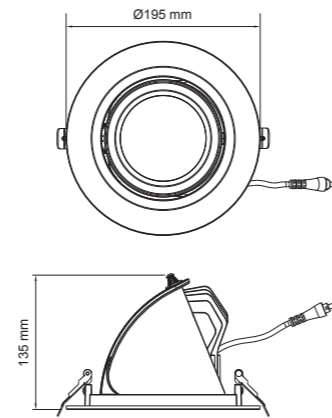

Ø 165-180 mm

CALIFORNIA+

PRO OFD



• Material



• Opc. de Regulación



• Opcional

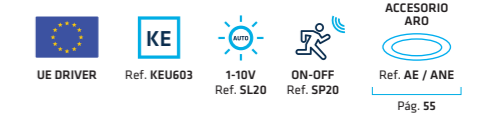

• Certif.

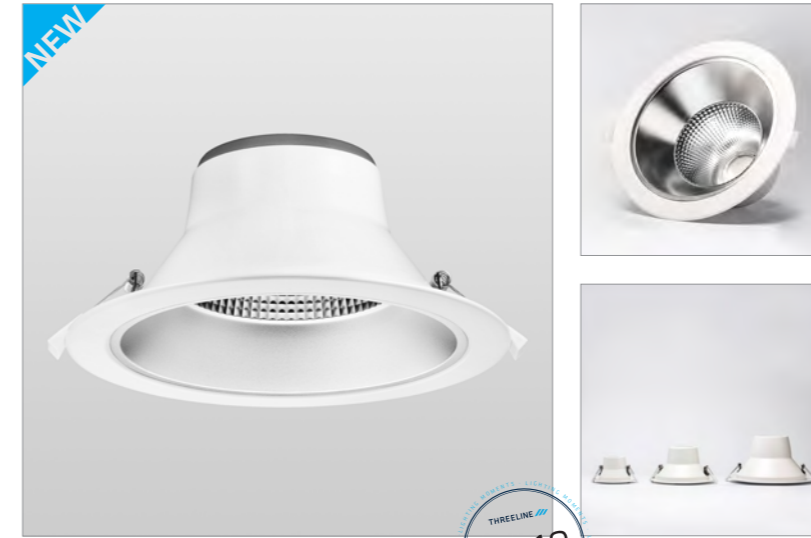

UGR <19

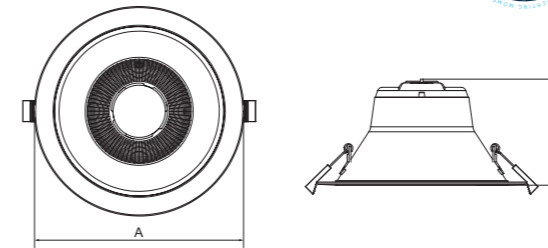

	A	B	OFD10UCCT	OFD20UCCT	OFD28UCCT
OFD10UCCT	Ø 113 mm	69 mm	Ø 87-105 mm	Ø 145-165 mm	Ø 190-225 mm
OFD20UCCT	Ø 174 mm	89 mm			
OFD28UCCT	Ø 232 mm	113 mm			



CCT SWITCH

OPCIONES	W	CCT	Beam	Beam
OFD10UCCT *	10 W	6000K	1100 lm	850 lm
		4000K	1100 lm	850 lm
		3000K	1050 lm	800 lm
OFD20UCCT *	20 W	6000K	2200 lm	1800 lm
		4000K	2200 lm	1800 lm
		3000K	2100 lm	1600 lm
OFD28UCCT *	28 W	6000K	3080 lm	2380 lm
		4000K	3080 lm	2380 lm
		3000K	2940 lm	2240 lm

* Opc. de Reg.

DT 0/1-10V, DALI, PUSH
D5 CASAMBI

* Opcional

UE UE DRIVER S1 SENSOR MOVIMIENTO
E KIT DE EMERGENCIA S2 SENSOR LUMINOSIDAD

BOSTON

PREMIUM DLB10 / DLB20
DLB28 / DLB35 / DLB45

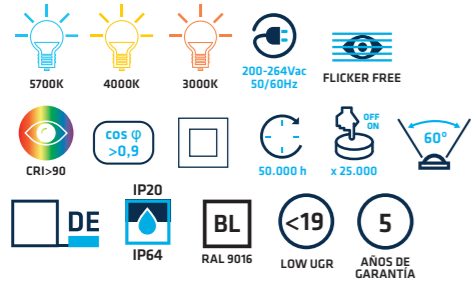

• Material: PC OPAL, AL, AL, DIFUSOR, CUERPO, REFLECTOR
• Certif.: CE

• Opc. de Regulación: 0/1-10V, PUSH, DALI, CASAMBI, 0-10V Ref. MDRF

• Opcional / Accesorios: UE DRIVER, KE, 1-10V Ref. SL20, ON-OFF Ref. SP20, ACCESORIO ARD Ref. AE / ANE



THREELINE
UGR<19

	A	B
DLB10	Ø 114 mm	66 mm
DLB20	Ø 174 mm	87 mm
DLB28 / DLB35 / DLB45	Ø 232 mm	110 mm

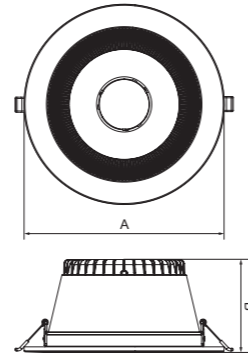

III III	OPCIONES	W	CCT	lm	lm
DLB10C957	*	10 W	5700K	1150	900
DLB10C940	*	10 W	4000K	1150	900
DLB10C930	*	10 W	3000K	1100	850
DLB20C957	*	20 W	5700K	2300	1800
DLB20C940	*	20 W	4000K	2300	1800
DLB20C930	*	20 W	3000K	2200	1700
DLB28C957	*	28 W	5700K	3220	2520
DLB28C940	*	28 W	4000K	3220	2520
DLB28C930	*	28 W	3000K	3080	2380
DLB35C957	*	35 W	5700K	4025	3150
DLB35C940	*	35 W	4000K	4025	3150
DLB35C930	*	35 W	3000K	3850	2975
DLB45C957	*	45 W	5700K	5175	4050
DLB45C940	*	45 W	4000K	5175	4050
DLB45C930	*	45 W	3000K	4950	3825

* Opc. de Reg. DT 0/1-10V, DALI, PUSH; D5 CASAMBI
* Opcional UE UE DRIVER; E KIT DE EMERGENCIA; S1 SENSOR MOVIMIENTO; S2 SENSOR LUMINOSIDAD

BOSTON

PREMIUM DLB10 / DLB20
DLB28 / DLB35 / DLB45

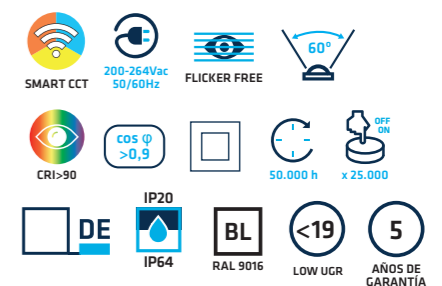

• Material: PC OPAL, AL, AL, DIFUSOR, CUERPO, REFLECTOR
• Certif.: CE

• Opcional / Accesorios



THREELINE
HCL

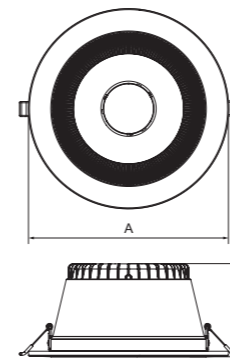

	A	B
DLB10	Ø 114 mm	66 mm
DLB20	Ø 174 mm	87 mm
DLB28 / DLB35 / DLB45	Ø 232 mm	110 mm

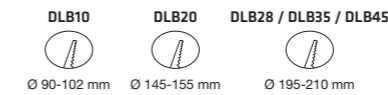

III III	W	CCT	lm	lm
DLB10C9SMT	10 W	5700K	1150	900
		4000K	1150	900
		3000K	1100	850
DLB20C9SMT	20 W	5700K	2300	1800
		4000K	2300	1800
		3000K	2200	1700
DLB28C9SMT	28 W	5700K	3220	2520
		4000K	3220	2520
		3000K	3080	2380
DLB35C9SMT	35 W	5700K	4025	3150
		4000K	4025	3150
		3000K	3850	2975
DLB45C9SMT	45 W	5700K	5175	4050
		4000K	5175	4050
		3000K	4950	3825

MONTANA

ECO DLM

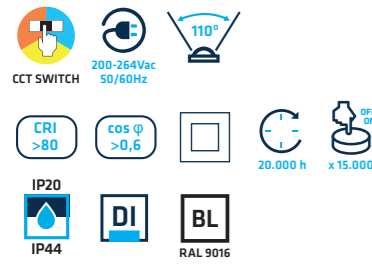

• Material • Certif.



• Opcional

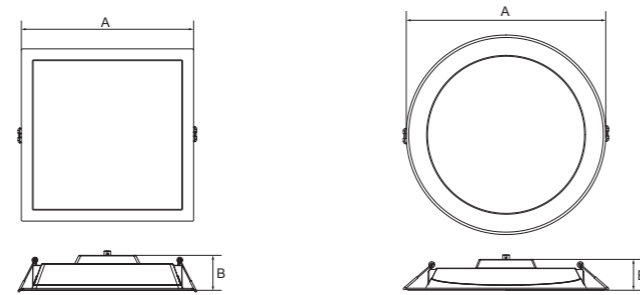
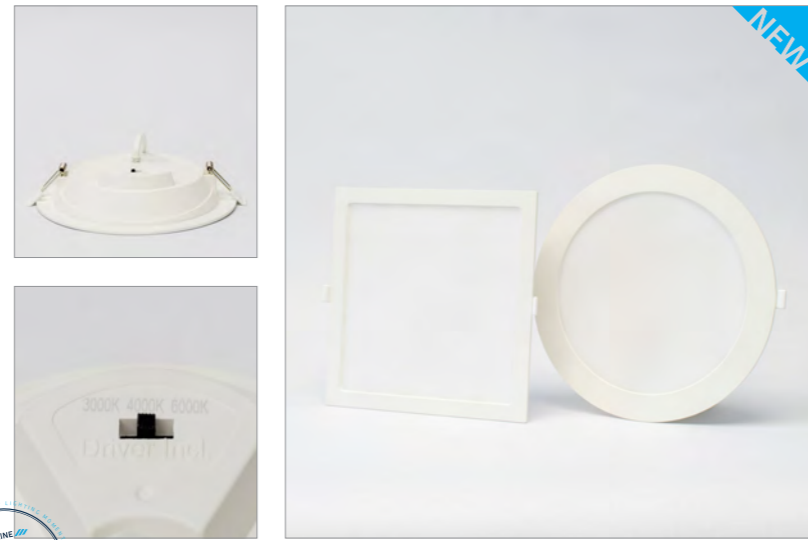
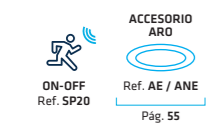

	A	B
DLM08CCCT	120 mm	38 mm
DLM12CCCT	170 mm	39 mm
DLM18CCCT / DLM25CCCT	220 mm	46 mm

	A	B
DLM08RCCT	Ø 113 mm	38 mm
DLM12RCCT	Ø 174 mm	39 mm
DLM18RCCT / DLM25RCCT	Ø 244 mm	39 mm

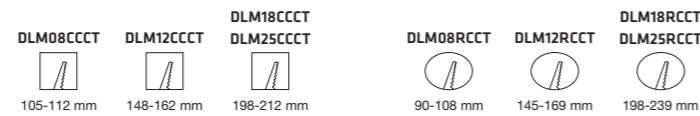

CCT SWITCH

OPCIONES	W	CCT	lm	lm
DLM08CCCT	8 W	6000K	880 lm	680 lm
		4000K	880 lm	680 lm
		3000K	840 lm	640 lm
DLM12CCCT	12 W	6000K	1320 lm	1020 lm
		4000K	1320 lm	1020 lm
		3000K	1260 lm	960 lm
DLM18CCCT	18 W	6000K	1980 lm	1530 lm
		4000K	1980 lm	1530 lm
		3000K	1890 lm	1440 lm
DLM25CCCT	25 W	6000K	2750 lm	2125 lm
		4000K	2750 lm	2125 lm
		3000K	2625 lm	2000 lm

* Opcional

S1 SENSOR MOVIMIENTO

ALASKA

PRO DL25WUGRIP65

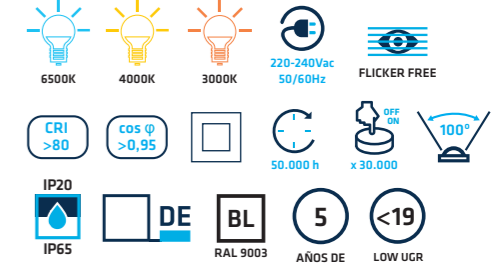

• Material



• Opc. de Reg.

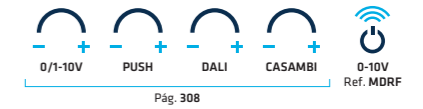

• Opcional

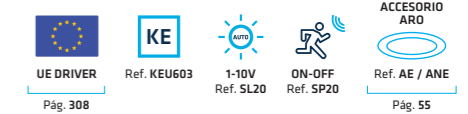

• Certif.

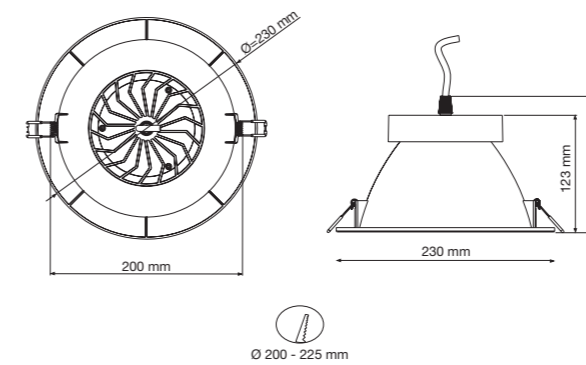

	CCT	W	lm	lm
DL25WUGRIP65BFBL	6500K	25 W	2500 lm	2000 lm
DL25WUGRIP65BNBL	4000K	25 W	2450 lm	1950 lm
DL25WUGRIP65BCBL	3000K	25 W	2400 lm	1900 lm

NEVADA

PRO ND10R / ND16R / ND20R

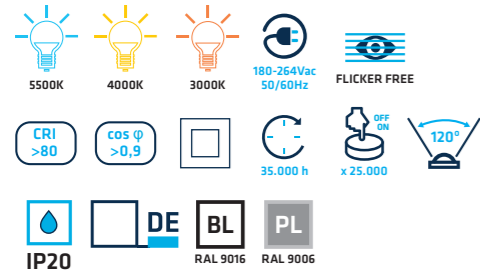

• Material



• Opc. de Reg.

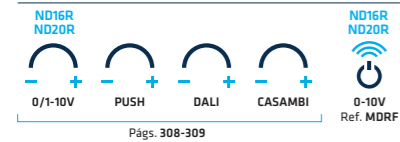

• Opcional



• Certif.

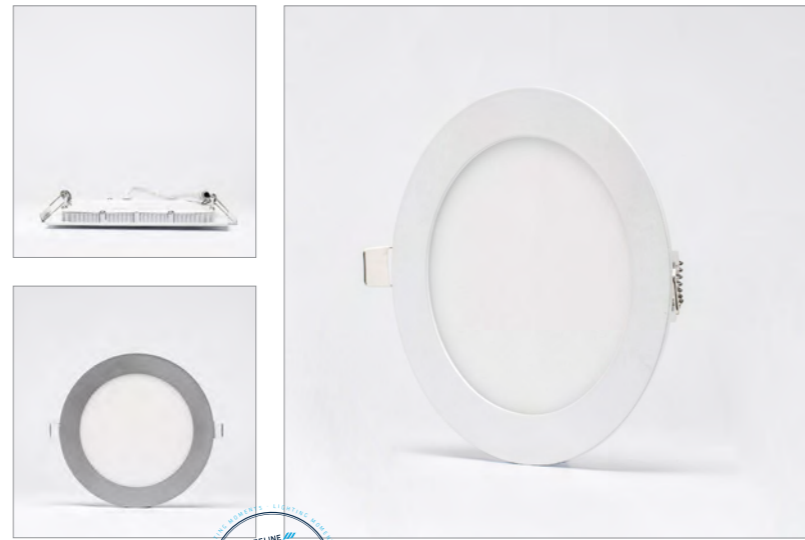

	A	B	C
ND10R	Ø 120 mm	Ø 76 mm	20 mm
ND16R	Ø 178 mm	Ø 132 mm	20 mm
ND20R	Ø 225 mm	Ø 175 mm	20 mm

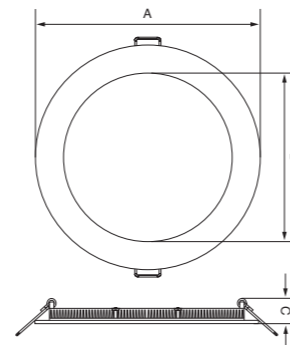
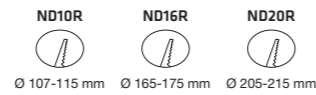

NEVADA

PRO ND10C / ND16C / ND20C

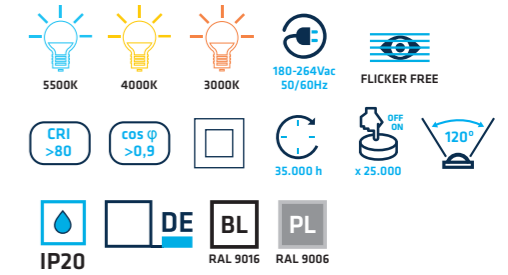

• Material



• Certif.



• Opc. de Reg.

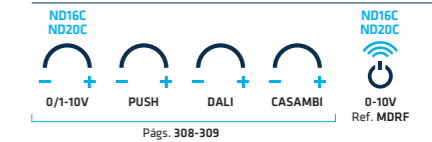

• Opcional

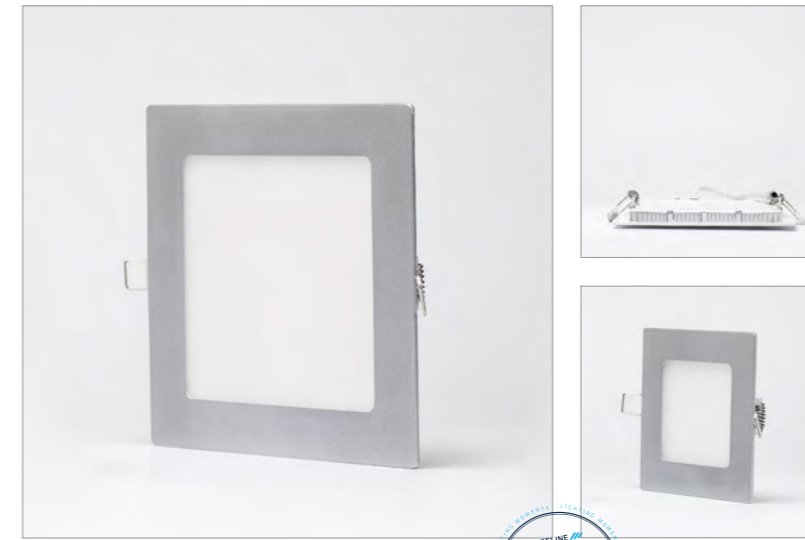
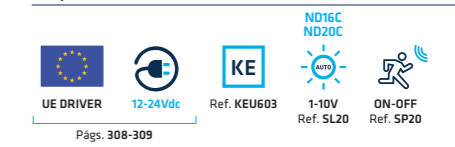

	A	B	C
ND10C	120 mm	73 mm	18 mm
ND16C	174 mm	122 mm	18 mm
ND20C	225 mm	174 mm	18 mm

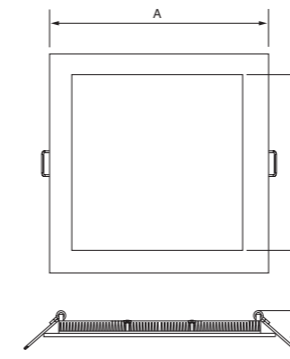
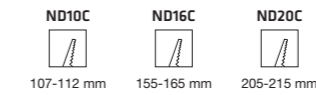

IIIII	CCT	W	☑	☀	☀
ND10RBFBL	● 5500K	9 W	☐	1008 lm	675 lm
ND10RBNBL	● 4000K	9 W	☐	990 lm	657 lm
ND10RBCBL	● 3000K	9 W	☐	963 lm	630 lm
ND10RBFPL	● 5500K	9 W	■	1008 lm	675 lm
ND10RBNPL	● 4000K	9 W	■	990 lm	657 lm
ND16RBFBL	● 5500K	12 W	☐	1200 lm	1020 lm
ND16RBNBL	● 4000K	12 W	☐	1260 lm	1080 lm
ND16RBCBL	● 3000K	12 W	☐	1140 lm	960 lm
ND16RBFPL	● 5500K	12 W	■	1200 lm	1020 lm
ND16RBNPL	● 4000K	12 W	■	1260 lm	1080 lm
ND20RBFBL	● 5500K	18 W	☐	1764 lm	1530 lm
ND20RBNBL	● 4000K	18 W	☐	1854 lm	1620 lm
ND20RBCBL	● 3000K	18 W	☐	1674 lm	1440 lm
ND20RBFPL	● 5500K	18 W	■	1764 lm	1530 lm
ND20RBNPL	● 4000K	18 W	■	1854 lm	1620 lm

IIIII	CCT	W	☑	☀	☀
ND10CBFBL	● 5500K	9 W	☐	1008 lm	675 lm
ND10CBNBL	● 4000K	9 W	☐	990 lm	657 lm
ND10CBCBL	● 3000K	9 W	☐	963 lm	630 lm
ND10CBFPL	● 5500K	9 W	■	1008 lm	675 lm
ND10CBNPL	● 4000K	9 W	■	990 lm	657 lm
ND16CBFBL	● 5500K	12 W	☐	1200 lm	1020 lm
ND16CBNBL	● 4000K	12 W	☐	1260 lm	1080 lm
ND16CBCBL	● 3000K	12 W	☐	1140 lm	960 lm
ND16CBFPL	● 5500K	12 W	■	1200 lm	1020 lm
ND16CBNPL	● 4000K	12 W	■	1260 lm	1080 lm
ND20CBFBL	● 5500K	18 W	☐	1764 lm	1530 lm
ND20CBNBL	● 4000K	18 W	☐	1854 lm	1620 lm
ND20CBCBL	● 3000K	18 W	☐	1674 lm	1440 lm
ND20CBFPL	● 5500K	18 W	■	1764 lm	1530 lm
ND20CBNPL	● 4000K	18 W	■	1854 lm	1620 lm

NEVADA

PRO ND10R-S / ND16R-S / ND20R-S

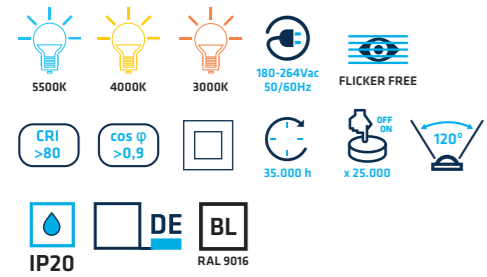

• Material



• Opc. de Reg.

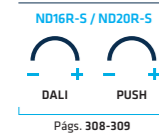

• Opcional

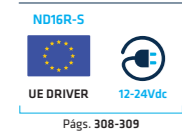

• Certif.

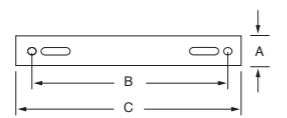

	A	B	C
ND10R-S / ND10C-S	20 mm	81 mm	115 mm
ND16R-S / ND16C-S	20 mm	104 mm	166 mm
ND20R-S / ND20C-S	20 mm	185 mm	218 mm

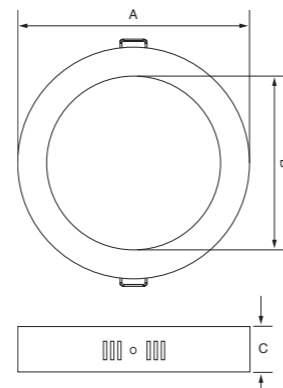

	A	B	C
ND10R-S	∅ 120 mm	∅ 78 mm	38 mm
ND16R-S	∅ 170 mm	∅ 127 mm	39 mm
ND20R-S	∅ 222 mm	∅ 175 mm	39 mm

NEVADA

PRO ND10C-S / ND16C-S / ND20C-S

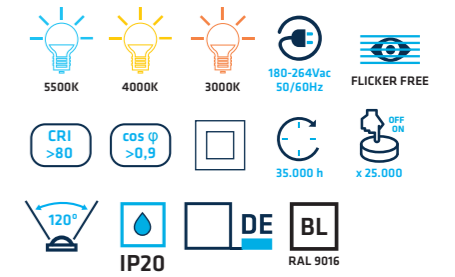

• Material



• Opc. de Reg.

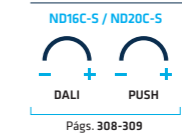

• Opcional



• Certif.

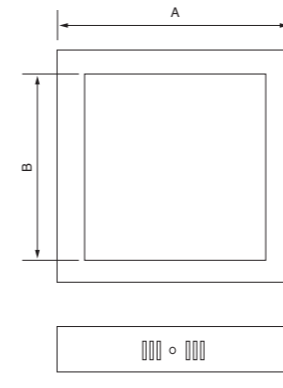

	A	B	C
ND10C-S	120 mm	73 mm	38 mm
ND16C-S	170 mm	122 mm	39 mm
ND20C-S	225 mm	174 mm	39 mm

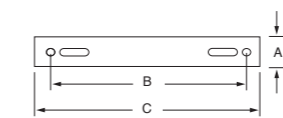

	A	B	C
ND10C-S	20 mm	81 mm	115 mm
ND16C-S	20 mm	104 mm	166 mm
ND20C-S	20 mm	185 mm	218 mm

Icon	W	CCT	Beam Angle	Light Output
ND10R-SBFBL	9 W	5500K	1008 lm	675 lm
ND10R-SBNBL	9 W	4000K	990 lm	657 lm
ND10R-SBCBL	9 W	3000K	963 lm	630 lm
ND16R-SBFBL	12 W	5500K	1200 lm	1020 lm
ND16R-SBNBL	12 W	4000K	1260 lm	1080 lm
ND16R-SBCBL	12 W	3000K	1140 lm	960 lm
ND20R-SBFBL	18 W	5500K	1764 lm	1530 lm
ND20R-SBNBL	18 W	4000K	1854 lm	1620 lm
ND20R-SBCBL	18 W	3000K	1674 lm	1440 lm

Icon	W	CCT	Beam Angle	Light Output
ND10C-SBFBL	9 W	5500K	1008 lm	675 lm
ND10C-SBNBL	9 W	4000K	990 lm	657 lm
ND10C-SBCBL	9 W	3000K	963 lm	630 lm
ND16C-SBFBL	12 W	5500K	1200 lm	1020 lm
ND16C-SBNBL	12 W	4000K	1260 lm	1080 lm
ND16C-SBCBL	12 W	3000K	1140 lm	960 lm
ND20C-SBFBL	18 W	5500K	1764 lm	1530 lm
ND20C-SBNBL	18 W	4000K	1854 lm	1620 lm
ND20C-SBCBL	18 W	3000K	1674 lm	1440 lm

MISURI

PRO MSR

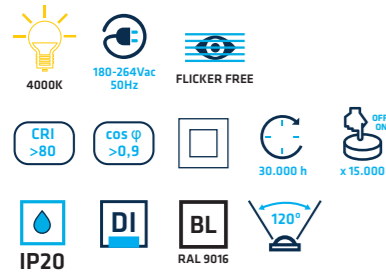

• Material



• Opcional



• Certif.

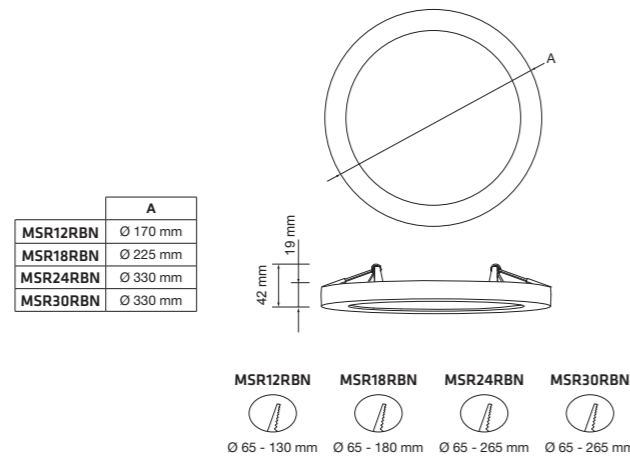

MONTAJE EN SUPERFICIE
MONTAGEM EM SUPERFÍCIE

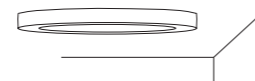

MONTAJE EMPOTRADO
MONTAGEM DE ENCASTRAR

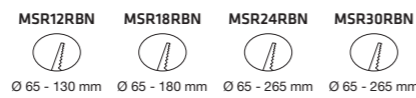
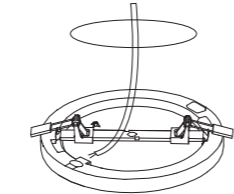

MICHIGAN

ECO DG20R

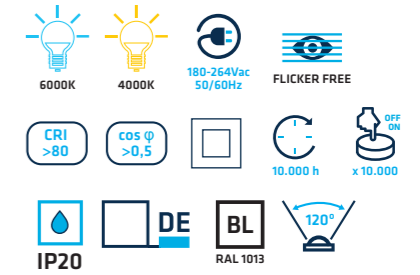

• Material



• Opc. de Reg.

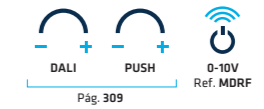

• Opcional

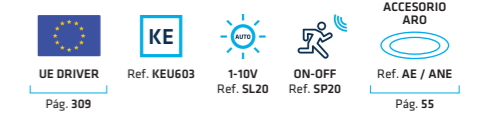

• Certif.

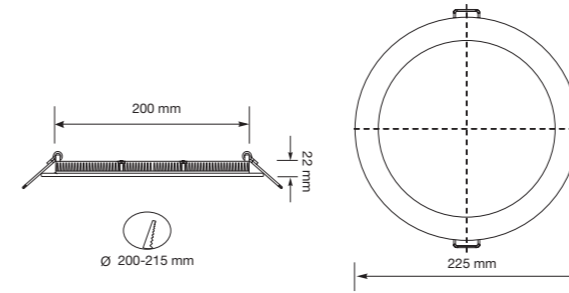

	CCT	W	☀	☾
DG20RBFBL	● 6000K	18 W	1800 lm	1300 lm
DG20RBNBL	● 4000K	18 W	1764 lm	1270 lm

	CCT	W	☀	☾
MSR12RBN	● 4000K	12 W	1260 lm	1020 lm
MSR18RBN	● 4000K	18 W	1890 lm	1530 lm
MSR24RBN	● 4000K	24 W	2520 lm	2040 lm
MSR30RBN	● 4000K	30 W	3150 lm	2550 lm

IRIS

MINIDLO3

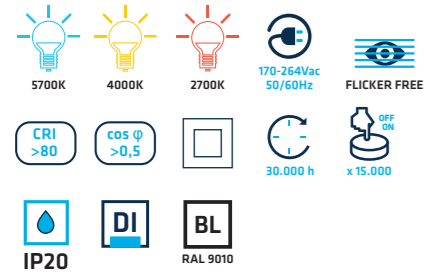

• Material



• Opcional



• Certif.



CONEXIÓN CON BORNAS METÁLICAS
LIGAÇÃO COM BORNES METÁLICOS

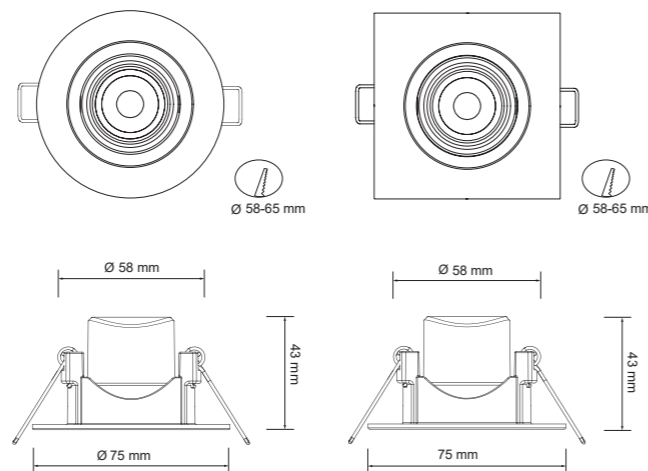

MINIDLO3RBF45	MINIDLO3CBF45	CCT	W	300 lm	261 lm	45°
MINIDLO3RBN45	MINIDLO3CBN45	4000K	3 W	294 lm	240 lm	45°
MINIDLO3RBC45	MINIDLO3CBC45	2700K	3 W	285 lm	218 lm	45°
MINIDLO3RBF90	MINIDLO3CBF90	5700K	3 W	300 lm	261 lm	90°
MINIDLO3RBN90	MINIDLO3CBN90	4000K	3 W	294 lm	240 lm	90°
MINIDLO3RBC90	MINIDLO3CBC90	2700K	3 W	285 lm	218 lm	90°

IRIS

MINIDLO7

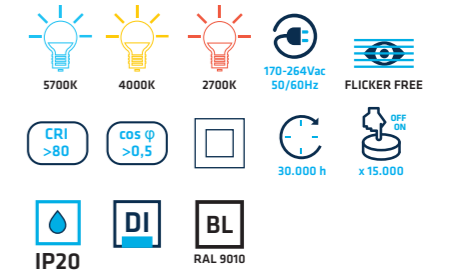

• Material



• Opc. de Reg.



• Opcional



• Certif.



CONEXIÓN CON BORNAS METÁLICAS
LIGAÇÃO COM BORNES METÁLICOS

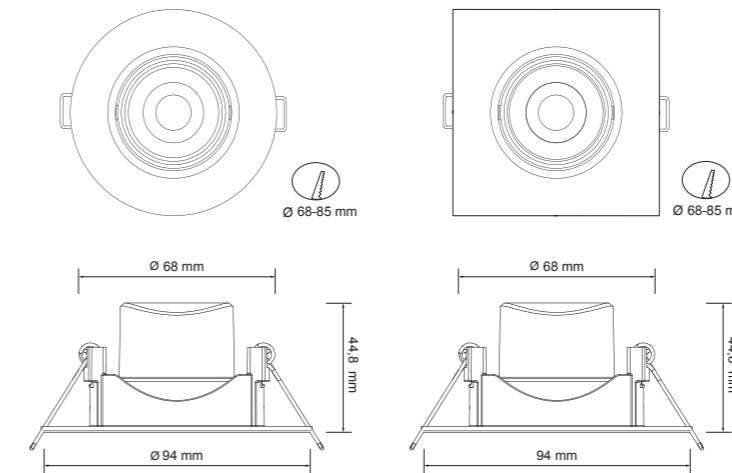

MINIDLO7RBF45	MINIDLO7RDBF45	MINIDLO7CBF45	MINIDLO7CDBF45	CCT	W	700 lm	609 lm	45°
MINIDLO7RBN45	MINIDLO7RDBN45	MINIDLO7CBN45	MINIDLO7CDBN45	4000K	7 W	686 lm	588 lm	45°
MINIDLO7RBC45	MINIDLO7RDBC45	MINIDLO7CBC45	MINIDLO7CDBC45	2700K	7 W	665 lm	560 lm	45°
MINIDLO7RBF90	MINIDLO7RDBF90	MINIDLO7CBF90	MINIDLO7CDBF90	5700K	7 W	700 lm	609 lm	90°
MINIDLO7RBN90	MINIDLO7RDBN90	MINIDLO7CBN90	MINIDLO7CDBN90	4000K	7 W	686 lm	588 lm	90°
MINIDLO7RBC90	MINIDLO7RDBC90	MINIDLO7CBC90	MINIDLO7CDBC90	2700K	7 W	665 lm	560 lm	90°

IRIS

MINIDLO12

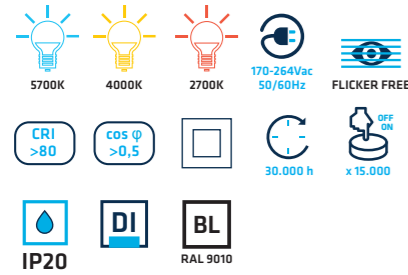

• Material



• Opcional



• Certif.



CONEXIÓN CON BORNAS METÁLICAS
LIGAÇÃO COM BORNES METÁLICOS

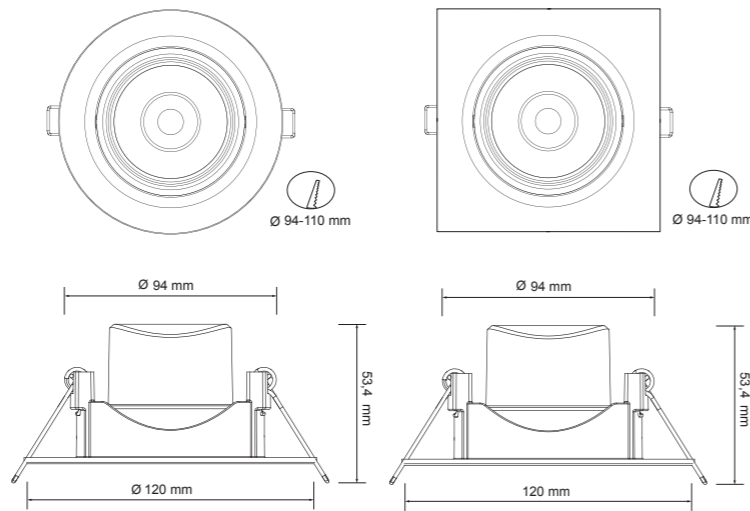

MINIDLO12RBF45	MINIDLO12CBF45	CCT	W	170-264Vac 50/60Hz	170-264Vac 50/60Hz	β
MINIDLO12RBF45	MINIDLO12CBF45	5700K	12 W	1200 lm	1044 lm	45°
MINIDLO12RBN45	MINIDLO12CBN45	4000K	12 W	1176 lm	1020 lm	45°
MINIDLO12RBC45	MINIDLO12CBC45	2700K	12 W	1140 lm	998 lm	45°
MINIDLO12RBF90	MINIDLO12CBF90	5700K	12 W	1200 lm	1044 lm	90°
MINIDLO12RBN90	MINIDLO12CBN90	4000K	12 W	1176 lm	1020 lm	90°
MINIDLO12RBC90	MINIDLO12CBC90	2700K	12 W	1140 lm	998 lm	90°

DOWNLIGHTS. ACCESORIOS / ACESSÓRIOS



ARO EMBELLECEDOR EMPOTRABLE

DIMENSIONES

Las dimensiones dependerán de las necesidades de cada instalación y del downlight a instalar.

El AE está indicado para cubrir huecos en los que la diferencia entre el diámetro de corte del techo y el de instalación del downlight es ≥ 25 mm.

El downlight siempre permanecerá en la parte inferior, y el accesorio entre el techo y el downlight.

ARO DE ACABAMENTO DE ENCASTRAR

DIMENSÕES

As dimensões dependem das necessidades de cada instalação e do downlight a instalar.

O AE está indicado para tapar buracos em que a diferença entre o diâmetro de corte do tecto e a dimensão do downlight é superior a 25 mm.

O downlight permanecerá sempre na parte inferior e o acessório entre o tecto e o downlight.



ARO EMBELLECEDOR NO EMPOTRABLE

DIMENSIONES

El ANE está indicado para cubrir huecos en los que la diferencia entre el diámetro de corte del techo y el de instalación del downlight es < 25 mm.

El downlight siempre permanecerá en la parte inferior, y el accesorio entre el techo y el downlight.

ARO DE ACABAMENTO NÃO ENCASTRÁVEL

DIMENSÕES

O ANE está indicado para tapar buracos em que a diferença entre o diâmetro de corte do tecto e a dimensão do downlight é inferior a 25 mm.

O downlight permanecerá sempre na parte inferior e o acessório entre o tecto e o downlight.

Ref. AE



AL
RAL 9003

Ref. ANE



AL
RAL 9003

Plafones Plafons



CEILING+ PRO NEW



IP64

TECTUM+ PRO NEW

IP65



CEILING+

PRO CEL



• Material



• Opcional



• Certif.

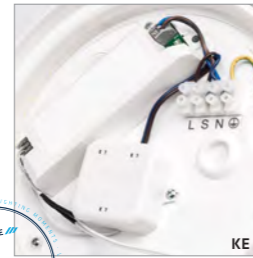

IP64
NUEVO DISEÑO COMPACTO
NOVO DESIGN COMPACTO

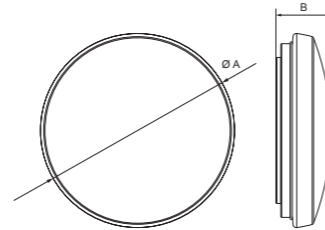
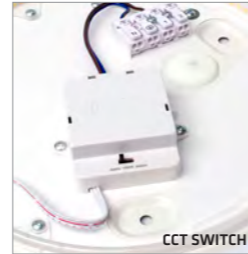

	A	B
CEL12W	Ø 280 mm	80 mm
CEL18W	Ø 360 mm	92 mm
CEL32W	Ø 410 mm	103 mm



CCT SWITCH

Icon	Icon	Icon	Icon	W	CCT	lm	lm
CEL12CCT	CEL12CCTE	CEL12CCTES3	CEL12CCTES3	12 W	● 5700K ● 4000K ● 3000K	1320 lm	1020 lm
CEL18CCT	CEL18CCTE	CEL18CCTES3	CEL18CCTES3	18 W	● 5700K ● 4000K ● 3000K	1980 lm	1530 lm
CEL32CCT	CEL32CCTE	CEL32CCTES3	CEL32CCTES3	32 W	● 5700K ● 4000K ● 3000K	3680 lm	2720 lm

TECTUM+

PRO TCT

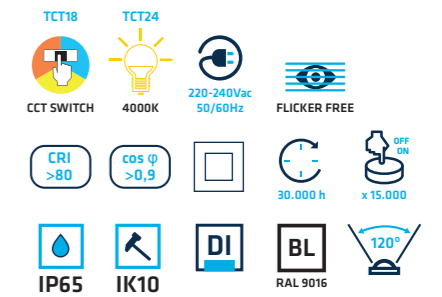

• Material



• Certif.



IP65

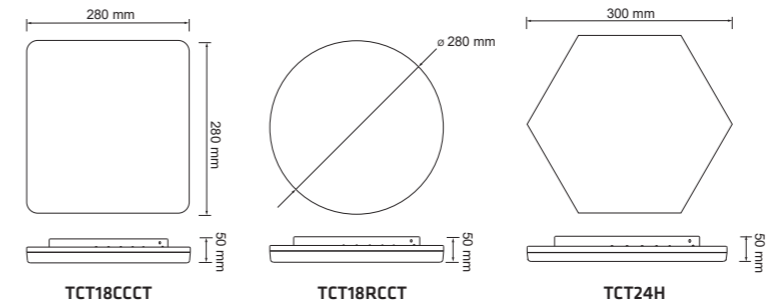

CCT SWITCH

Icon	Icon	W	CCT	lm	lm
TCT18RCCT	○	18 W	● 5700K ● 4000K ● 3000K	2520 lm	2160 lm
TCT18CCCT	□	18 W	● 5700K ● 4000K ● 3000K	2520 lm	2160 lm
TCT24HBN	⬡	24 W	● 4000K	2760 lm	2400 lm

Paneles Painéis



SLIM

- ACROPOLIS**
 P6060EUGR65
 6000K 4000K 5 AÑOS DE GARANTÍA IP65 <19 LOW UGR FLICKER FREE 595x595x18 mm
- METROPOLIS**
 P60X60EUGR9
 6000K 4000K 5 AÑOS DE GARANTÍA CRI>90 <19 LOW UGR FLICKER FREE 595x595x10 mm
- TRIPOLIS**
 P6060UGR
 P30120UGR
 P60120UGR
 6000K 4000K 3000K <19 LOW UGR FLICKER FREE 595x595x10 mm
 1195x295x18 mm
 1195x595x11 mm
- MICROPOLIS**
 P3030
 P3060
 4000K 5 AÑOS DE GARANTÍA 295x295x10,7 mm
 295x595x9,6 mm

BACKLIGHT

- NEOPOLIS**
 PS6060UGR
 6000K 4000K 3000K <19 LOW UGR FLICKER FREE 595x595x33 mm
- NEAPOLIS**
 PBN6060U40
 6000K 4000K 3000K <19 LOW UGR FLICKER FREE 595x595x27 mm
- EXAPOLIS**
 PBE606040
 6000K 4000K FLICKER FREE 595x595x27 mm

ACROPOLIS

PRO P6060EUGR65

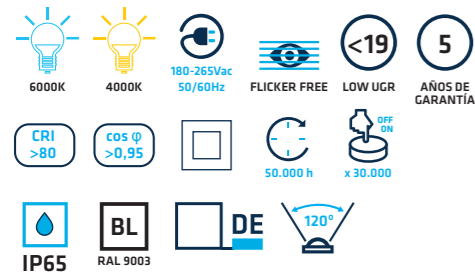

• Material



• Opc. de Reg.

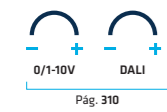

• Accesorios

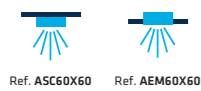

• Certif.

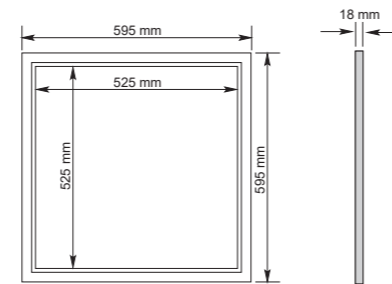
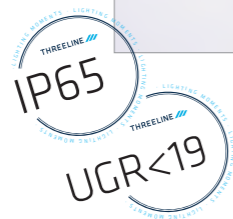

METROPOLIS

PRO P60X60EUGR9

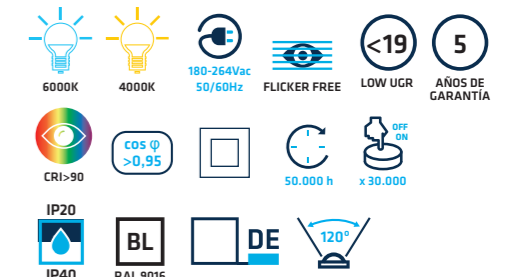

• Material



• Opc. de Reg.

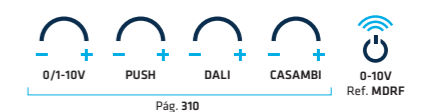

• Opcional



• Accesorios

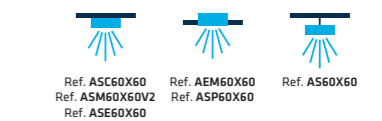

• Certif.

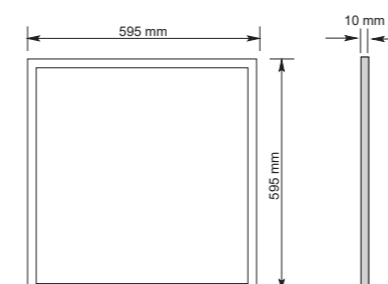

Icon	CCT	Dimensions	W	5000K Beam	4000K Beam
P6060EUGR65BF	6000K	595x595x18 mm	40 W	5200 lm	4400 lm
P6060EUGR65BN	4000K	595x595x18 mm	40 W	5120 lm	4280 lm

Icon	CCT	Dimensions	W	5000K Beam	4000K Beam
P60X60EUGR9BF	6000K	595x595x10 mm	40 W	5200 lm	4400 lm
P60X60EUGR9BN	4000K	595x595x10 mm	40 W	5120 lm	4280 lm

PANELES / PAINÉIS

- 1 PLACA COBERTORA**
PLACA DE COBERTURA
Placa trasera metálica, marco de aluminio.
Placa traseira metálica, aro em alumínio
- 2 ESPUMA DE PROTECCIÓN**
ESPUMA DE PROTEÇÃO
Protege las placas interiores contra cualquier agresión externa.
Protege as placas interiores contra qualquer agressão externa.
- 3 PAPEL REFLECTANTE**
PAPEL REFLECTOR
Evita el desperdicio de la luz. Proyecta la luz hacia el exterior.
Evita o desperdício de luz, projetando-a para o exterior.
- 4 PLACA GUÍA DE LUZ**
PLACA GUIA DE LUZ
Logra una homogeneidad luminosa gracias a la matriz de puntos grabada.
Placa rugosa que permite a homogeneidade da luz.
- 5 DIFUSOR TRANSLÚCIDO**
DIFUSOR TRANSLÚCIDO
Reparte la luz emitida por los LEDs hacia abajo.
Mejora la distribución luminosa.
Reparte a luz emitida pelos LEDs direcionando-a para baixo e melhorando a distribuição da luz.
- 6 DIFUSOR MICROPRISMÁTICO**
DIFUSOR MICROPRISMÁTICO
La estructura piramidal logra índices URG<19.
Consigue una luminosidad homogénea y libre de reflejos.
Estrutura piramidal que permite índices URG <19 e uma luminosidade homogénea e livre de reflexos.
- 7 LED EN PLACA DE ALUMINIO**
LEDS EM PLACA DE ALUMÍNIO
El aluminio permite una mejor disipación del calor.
LEDs SMD 4014 distribuidos en paralelo asegurando la luz constante de los LEDs de forma independiente.
O alumínio permite uma maior e melhor dissipação de calor.
Os LEDs SMD 4014, distribuidos em paralelo, asseguram a luz de forma constante e independente entre si.



TRIPOLIS

PRO P6060UGR / P30120UGR / P60120UGR

6000K 4000K 3000K 180-264Vac 50/60 Hz FLICKER FREE LOW UGR <19

CRI >80 cos φ >0,95 50.000 h x 30.000

IP20 IP40 BL RAL 9016 DE 120°

• Material • Certif.

PS AL DIFUSOR CUERPO CE ENAC CB

• Opc. de Reg.

0/1-10V DALI PUSH CASAMBI

Pág. 310

0-10V/DA Ref. MDRF 0-10V/DA Ref. CSB110DA

• Opcional

UE DRIVER IP44 KE Ref. KEU2403 1-10V Ref. SL20 ON-OFF Ref. SP20

Pág. 310

• Accesorios

P6060UGR Ref. ASC60X60 Ref. ASM60X60V2 Ref. ASE60X60 Ref. AEM60X60 Ref. ASP60X60 Ref. A560X60

P30120UGR Ref. ASC30X120 Ref. ASM30X120V2 Ref. ASE120 Ref. AEM30X120 Ref. AEP120 Ref. AS120

P60120UGR Ref. ASC60X120 Ref. ASM60X120V2 Ref. ASE120 Ref. AEM60X120 Ref. AEP120 Ref. AS120

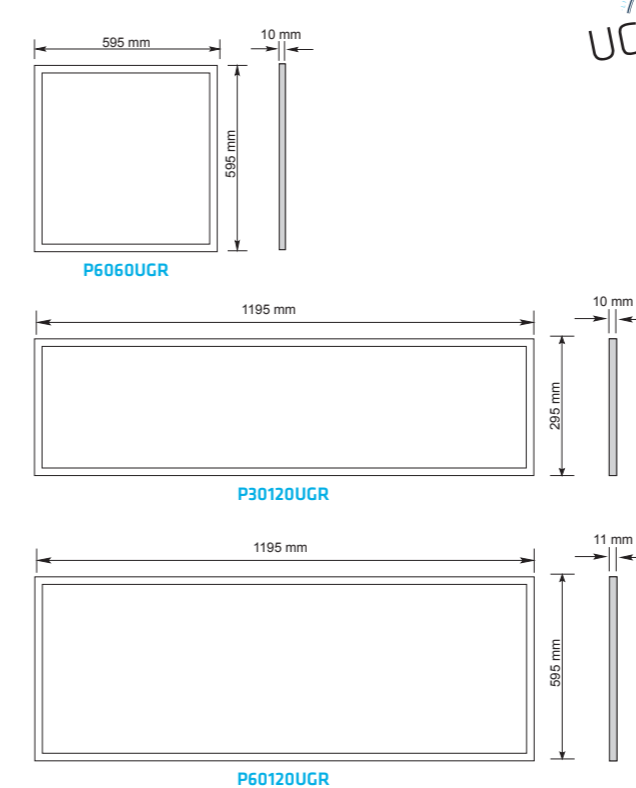
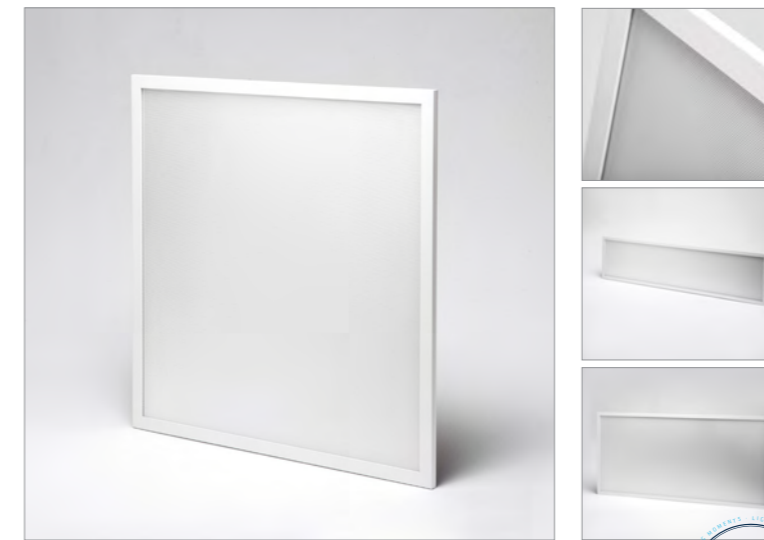

Model	CCT	Dimensions (mm)	W	Light Output (lm)	Beam Angle
P6060UGRBF	6000K	595x595x10	40 W	5200 lm	4040 lm
P6060UGRBN	4000K	595x595x10	40 W	5120 lm	4010 lm
P6060UGRBC	3000K	595x595x10	40 W	4920 lm	3800 lm
P30120UGRBF	6000K	1195x295x10	40 W	5200 lm	4040 lm
P30120UGRBN	4000K	1195x295x10	40 W	5120 lm	4010 lm
P30120UGRBC	3000K	1195x295x10	40 W	4920 lm	3800 lm
P60120UGRBF	6000K	1195x595x11	50 W	6500 lm	5050 lm
P60120UGRBN	4000K	1195x595x11	50 W	6400 lm	5010 lm
P60120UGRBC	3000K	1195x595x11	50 W	6150 lm	4750 lm

MICROPOLIS

PRO P3030 / P3060

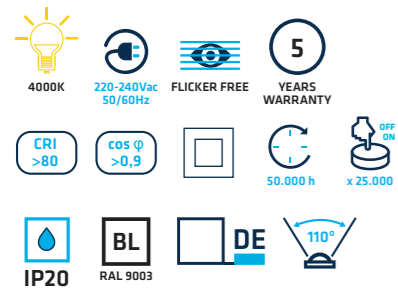

• Material



• Opc. de Reg.

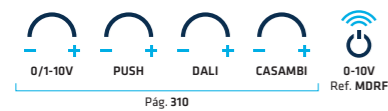

• Optional



• Accesorios

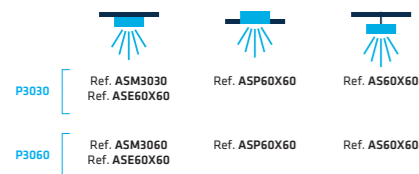

• Certif.



Model	CCT	Dimensions	W	Beam Angle	Light Output
P3030BN	4000K	295x295x10,7 mm	12 W	1200 lm	960 lm
P3060BN	4000K	595x295x9,6 mm	18 W	1980 lm	1620 lm

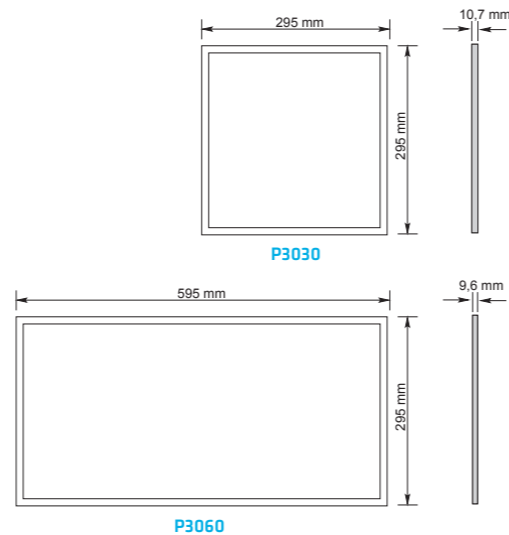

MICROPOLIS. ACCESORIOS / ACESSÓRIOS

SUPERFICIE / SUPERFÍCIE

Accesorio superficie marco / Acessório superfície com aro



ASM3030
ASM3060

Accesorio superficie esquadras. / Acessório superfície esquadria.



ASE60X60 (4 uds.)

EMPOTRAR / ENCASTRAR

Accesorio empotrar pinzas / Acessório encastrar com molas



ASP60X60 (4 uds.)

SUSPENSIÓN / SUSPENSÃO

Accesorio suspensión / Acessório suspensão



AS60X60 (4 uds.)

ACCESORIOS MICROPOLIS 30x30 / 30x60



MICROPOLIS

		P3030	P3060
Surface Frame	ASM3030	✓	✗
	ASM3060	✗	✓
	ASE60X60	✓	✓
Recessed Spring	ASP60X60	✓	✓
	AS60X60	✓	✓

NEOPOLIS

PRO PS6060UGR

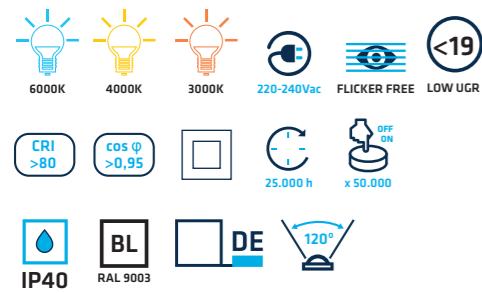

• Material



• Opc. de Reg.



• Opcional



• Accesorios

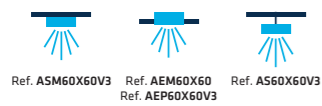

• Certif.

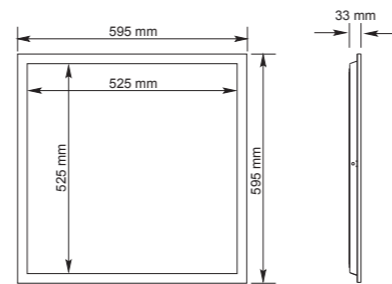
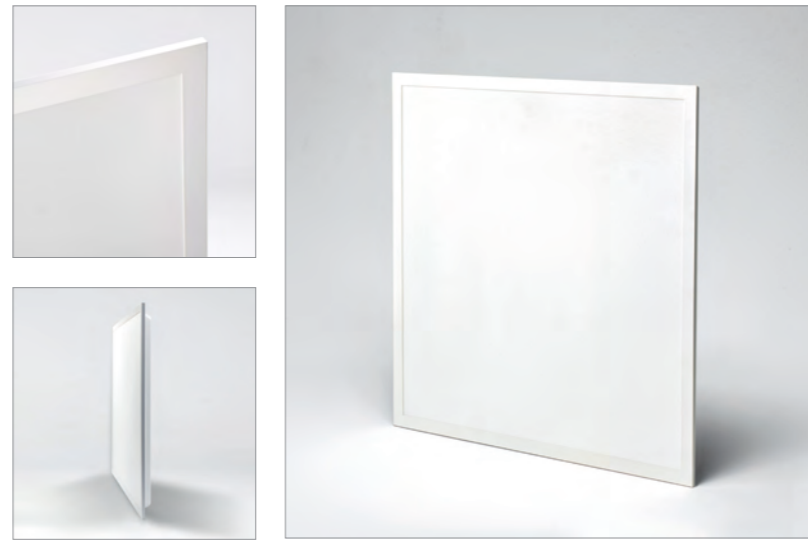

IIII	CCT	—	W	☀	☀
PS6060UGRBF	6000K	595x595x33 mm	40 W	4810 lm	4010 lm
PS6060UGRBN	4000K	595x595x33 mm	40 W	4810 lm	4010 lm
PS6060UGRBC	3000K	595x595x33 mm	40 W	4600 lm	3800 lm

NEOPOLIS. ACCESORIOS / ACESSÓRIOS

SUPERFICIE / SUPERFÍCIE

Accesorio superficie marco
Acessório superfície com aro



ASM60X60V3

EMPOTRAR / ENCASTRAR

Accesorio empotrar marco.
Acessório encastrar em suporte.

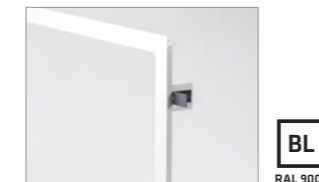

AEM60X60

Accesorio empotrar pinzas
Acessório encastrar com molas



AEP60X60V3 (4 uds.)

SUSPENSIÓN / SUSPENSÃO

Accesorio suspensión / Acessório suspensão



AS60X60V3

ACCESORIOS NEOPOLIS 60x60



NEOPOLIS

PS6060UGR

☀	ASM60X60V3	✓
☀	AEM60X60	✓
☀	AEP60X60V3	✓
☀	AS60X60V3	✓

NEAPOLIS

ECO PBN6060U40

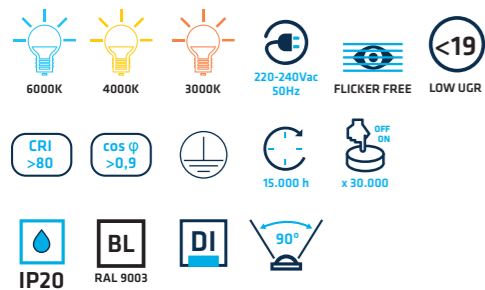

• Material



• Accesorios



• Certif.

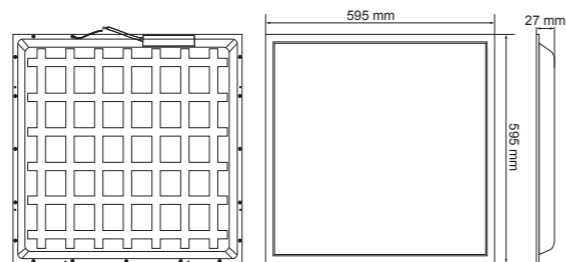

■■■■	CCT	≡	W	☀	☀
PBN6060U4060	6000K	595x595x27 mm	40 W	4880 lm	4080 lm
PBN6060U4040	4000K	595x595x27 mm	40 W	4880 lm	4080 lm
PBN6060U4030	3000K	595x595x27 mm	40 W	4600 lm	3800 lm

EXAPOLIS

ECO PBE606040

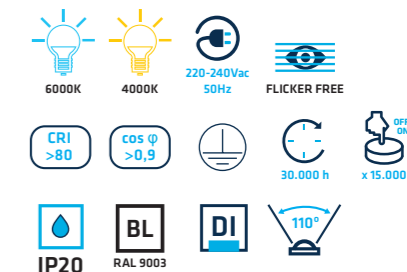

• Material



• Accesorios



• Certif.

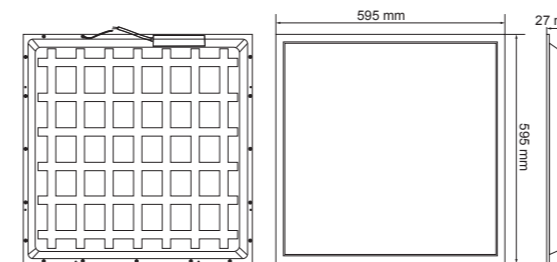

■■■■	CCT	≡	W	☀	☀
PBE60604060	6000K	595x595x33 mm	40 W	4880 lm	4080 lm
PBE60604040	4000K	595x595x33 mm	40 W	4880 lm	4080 lm

ACCESORIOS PANELES / ACESSÓRIOS PAINÉIS

SUPERFICIE / SUPERFÍCIE

Accesorio superficie cajón.
Acessório superfície com aro.



BL
RAL 9003

ASC60X60
ASC30X120
ASC60X120

Accesorio superficie marco.
Acessório superfície com aro.



BL
RAL 9003

ASM60X60V2
ASM30X120V2
ASM60X120V2

Accesorio superficie esquadras.
Acessório superfície esquadria.



ASE60X60 (4 uds.)
ASE120 (6 uds.)

Accesorio superficie marco.
Acessório superfície com aro.



BL
RAL 9003

ASM60X60V4

EMPOTRAR / ENCASTRAR

Accesorio empotrar marco.
Acessório encastrar em suporte.



BL
RAL 9003

AEM60X60
AEM30X120
AEM60X120

Accesorio empotrar pinzas.
Acessório encastrar com molas.



ASP60X60 (4 uds.)
AEP120 (6 uds.)

Accesorio empotrar pinzas.
Acessório encastrar em molas.



AEP60X60V4

SUSPENSIÓN / SUSPENSÃO

Accesorio suspensión.
Acessório suspensão.



AS60X60 (4 uds.)
AS120 (6 uds.)

Accesorio suspensión.
Acessório suspensão.



AS60X60V4

ACCESORIOS PANELES / ACESSÓRIOS PAINÉIS

ACCESORIOS PANELES SLIM 60x60



	ACROPOLIS	METROPOLIS	TRIPOLIS
	P6060EUGR65	P60X60EUGR9	P6060UGR

	ASC60X60	✓	✓	✓
	ASM60X60V2	✗	✓	✓
	ASE60X60	✗	✓	✓
	AEM60X60	✓	✓	✓
	ASP60X60	✗	✓	✓
	AS60X60	✗	✓	✓

ACCESORIOS PANELES SLIM 30x120 / 60x120



	TRIPOLIS
	P30120UGR P60120UGR

	ASC30X120	✓	✗
	ASC60X120	✗	✓
	ASM30X120V2	✓	✗
	ASM60X120V2	✗	✓
	ASE120	✓	✓
	AEM30X120	✓	✗
	AEM60X120	✗	✓
	AEP120	✓	✓
	AS120	✓	✓

ACCESORIOS PANELES BACKLIGHT 60x60



	EXAPOLIS	NEAPOLIS
	PBE606040	PBN6060U40

	ASM60X60V4	✓	✓
	AEM60X60	✓	✓
	AEP60X60V4	✓	✓
	AS60X60V4	✓	✓

Lineales

Lineares



DOWNLIGHTS
DOWNLIGHTS

PLAFONES
PLAFONS

PANELES
PAINÉIS

**LINEALES
LINEARES**

LÁMPARAS
LÂMPADAS

TUBOS
TUBOS

PRE-MIUM **SKYLINE**

6500K 4000K 3000K **120lm/W** reales/reais **5** AÑOS DE GARANTÍA

565 mm 845 mm 1125 mm 1405 mm 1685 mm

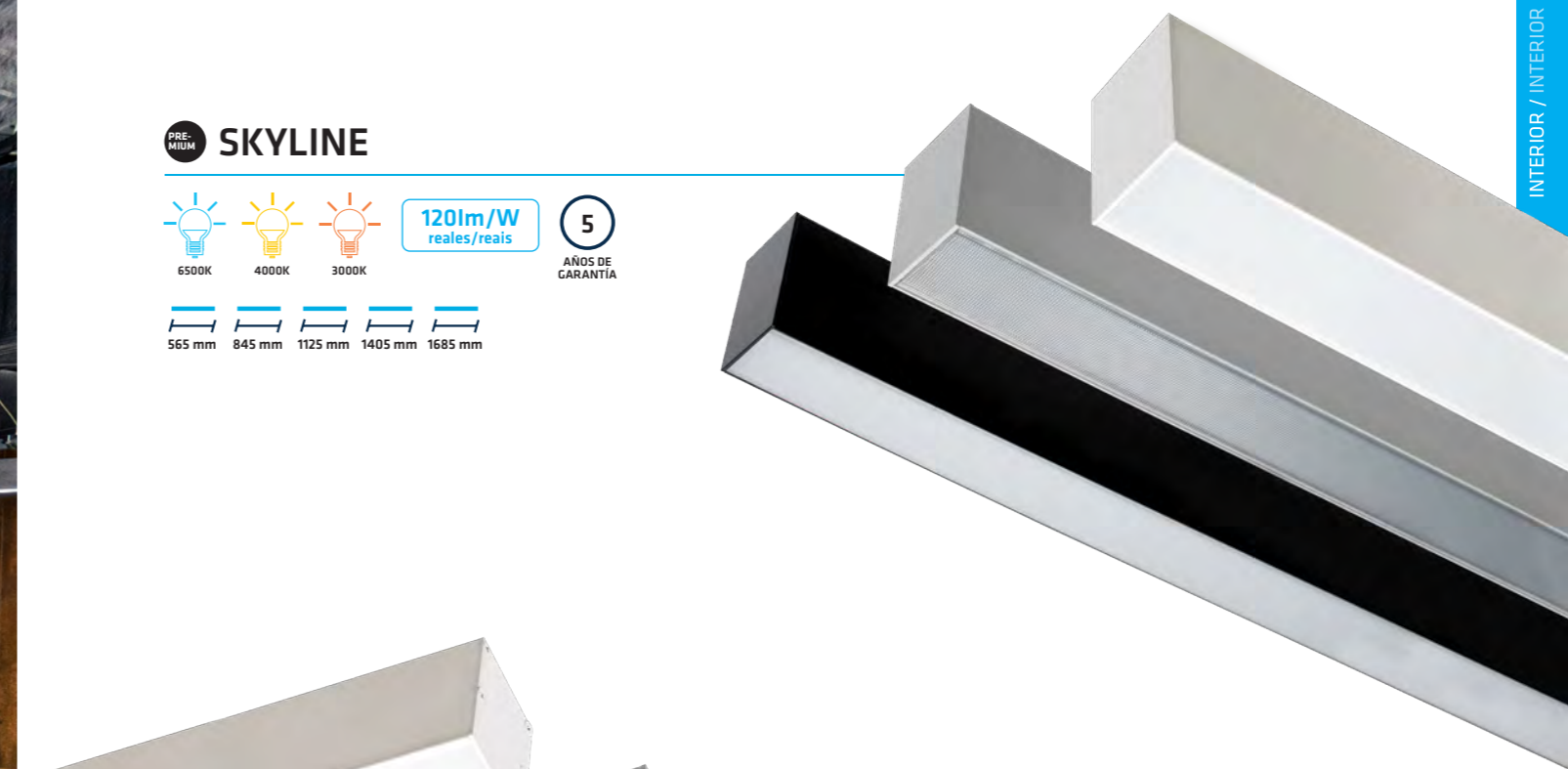

INTERIOR / INTERIOR

TURIA PRE-MIUM

5 AÑOS DE GARANTÍA **100lm/W** reales/reais 6500K 4000K 3000K

570 mm 850 mm 1130 mm 1410 mm 1690 mm



NEW PRO **ALTHEA**

5000K 4000K 3000K **150lm/W** reales/reais **5** AÑOS DE GARANTÍA

40x100° 70x100° 90x100° T25° 2T25°



SKYLINE vs TURIA

Instalación en línea continua / Instalação em linha contínua

1 SUSPENSIÓN / SUSPENSÃO

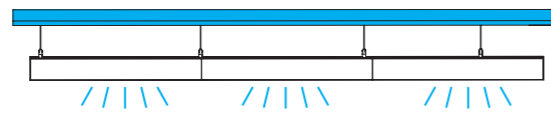

Colocar el lineal en suspensión es la **mejor opción** para techos irregulares.

Ajustando la longitud del cable se pueden compensar las variaciones del techo.

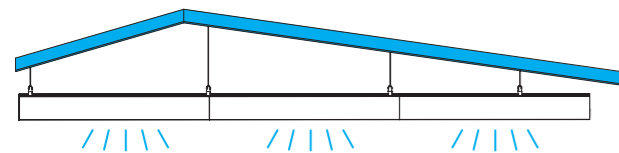

A instalação linear em suspensão é **ideal para tectos irregulares**.

Ajustando o comprimento dos cabos, é possível compensar as variações do tecto.

Para **línea continua en suspensión** utiliza siempre **SKYLINE** con cualquiera de sus accesorios.

Para instalações **lineares contínuas em suspensão**, utilize sempre SKYLINE con qualquer um dos seus acessórios.

	Decorativo	Hormigón	Madera y Chapa	Viga		Decorativo	Eco
Fijación al techo Fixação ao tecto					Fijación lineal Fixação linear		

2 SUPERFICIE / SUPERFÍCIE



A. Techos completamente lisos / Tectos completamente lisos

TURIA (Recomendado) / (Recomendado)

W	Accesorio	Distancia al techo	Tapa lateral
TURIA	(Incluido)	0 cm	
SKYLINE	ASKL (Eco)	1,5 cm	
	ASKL (Imán)	0,5 cm	
	ASKL01SP	0 cm	

B. Techos con pequeño desnivel / Tectos com pequenos desníveis

SKYLINE

Se puede utilizar para techo hueco, pladur o bovedilla, hormigón y macizo. Pode ser usado em tecto falsos, zonas em pladur ou maciças (como cimento).

W	Accesorio	Distancia al techo	Tapa lateral
SKYLINE	ASKL01SP	0 cm	

SKYLINE vs TURIA

Otro tipo de instalaciones / Outro tipo de instalações

1 EMPOTRAR / ENCASTRAR

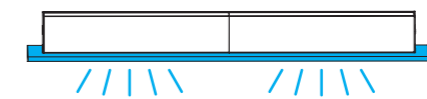

TURIA

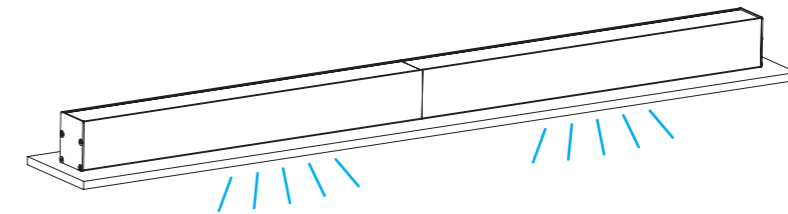

2 PARED / PAREDE



TURIA

A. Luz paralela a la pared / Luz paralela à parede

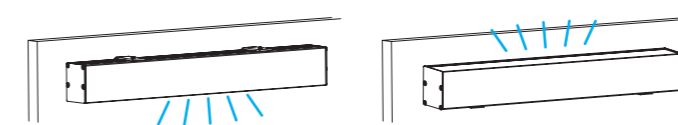

TURIA
Ref. TLR

ACCESORIO
 Ref. AES90TLRBL
 Ref. AES90TLRPL
 Ref. AES90TLRNE

B. Ángulo de 40° desde la pared / Ângulos de 40° a partir da parede

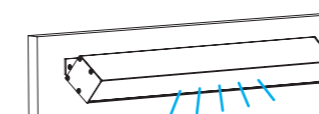

TURIA
Ref. TLR

ACCESORIO

Ref. AES40TLRBL
 Ref. AES40TLRPL
 Ref. AES40TLRNE

*Consultar otros ángulos / Consultar outros ângulos

3 LUZ INDIRECTA/ LUZ INDIRETA

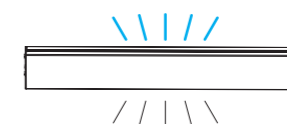

TURIA

A. En suspensión / Em suspensão

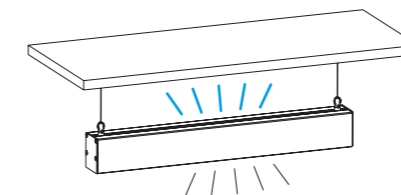

TURIA
Ref. TLR

LUZ INDIRECTA
Ref. ALITLR 1130 BN
CCT

ACCESORIO
Ref. ASTLR (pág. 186)

B. Desde pared / Desde a parede

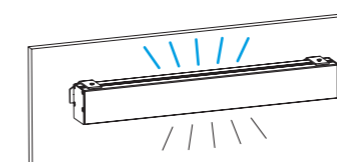

TURIA
Ref. TLR

LUZ INDIRECTA
Ref. ALITLR 1130 BN
CCT

ACCESORIO
 Ref. ATPTLRBL
 Ref. ATPTLRPL
 Ref. ATPTLRNE

SKYLINE

PREMIUM SKL

- 6500K 4000K 3000K
- 188-264Vac 50/60Hz
- Flicker free
- COG > 0,95
- 50.000 h
- OFF ON
- IP20
- 5 AÑOS DE GARANTÍA
- <19 LOW UGR

120lm/W reales/reais

Driver TRIDONIC

Molde propio
Molde próprio

Material



Opciones

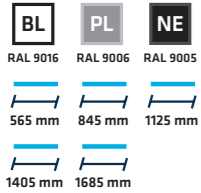

Opc. de Reg.

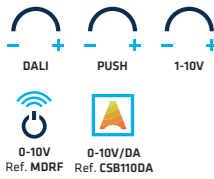

Opcional



Certif.

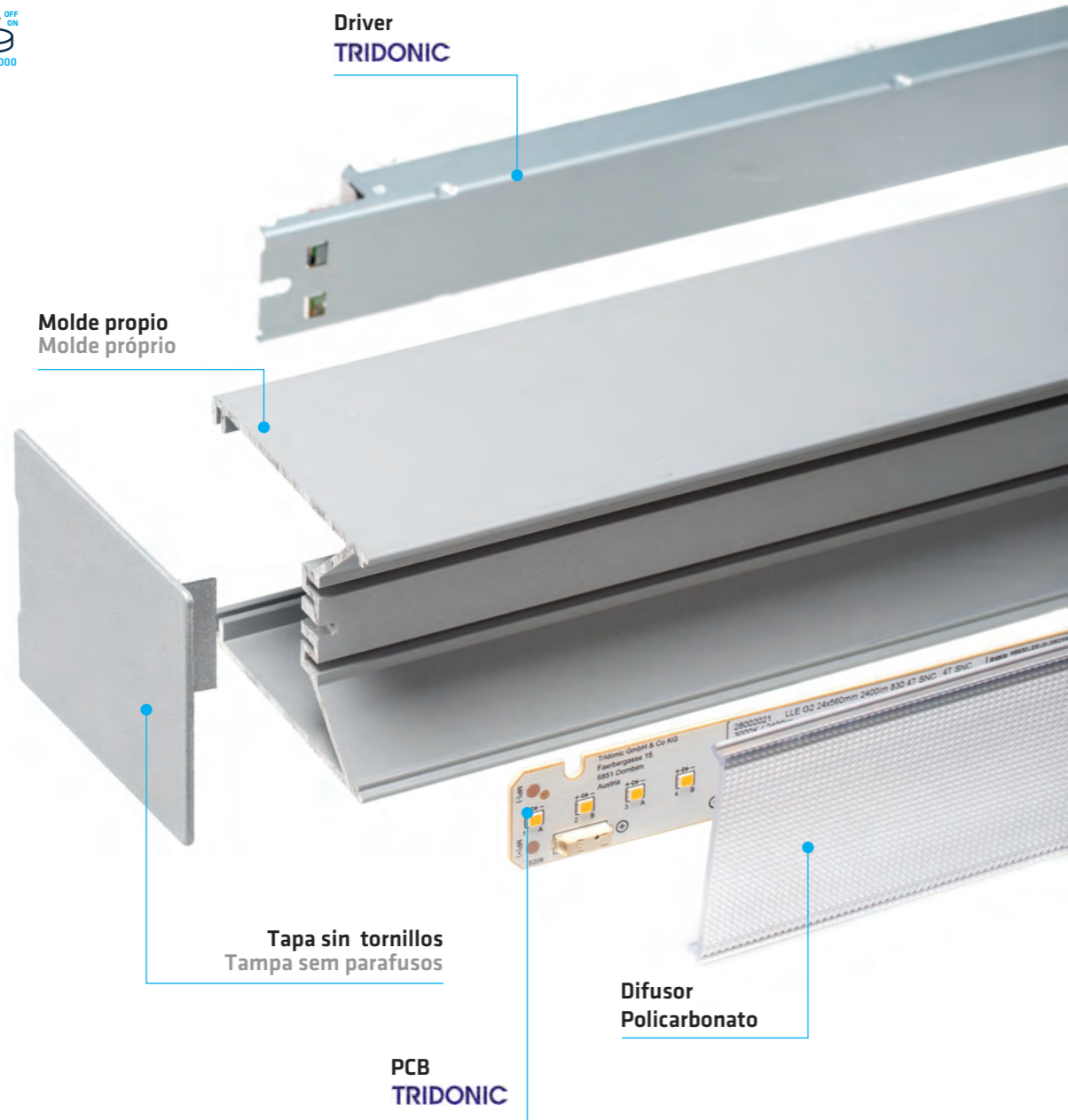

LINEAL EN SUSPENSIÓN / LINEAR EM SUSPENSÃO



¿Cómo va instalado el SKYLINE? Como instalar a luminária Skyline?

1 De manera independiente / Instalação independente

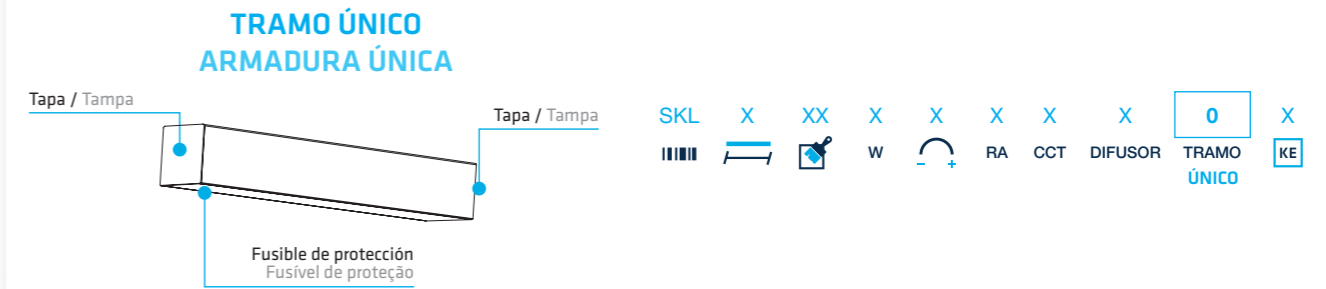

2 En línea continua / Instalação contínua

Para facilitar la instalación se diferencian distintos tramos / Cada armadura é distinta para facilitar a instalação

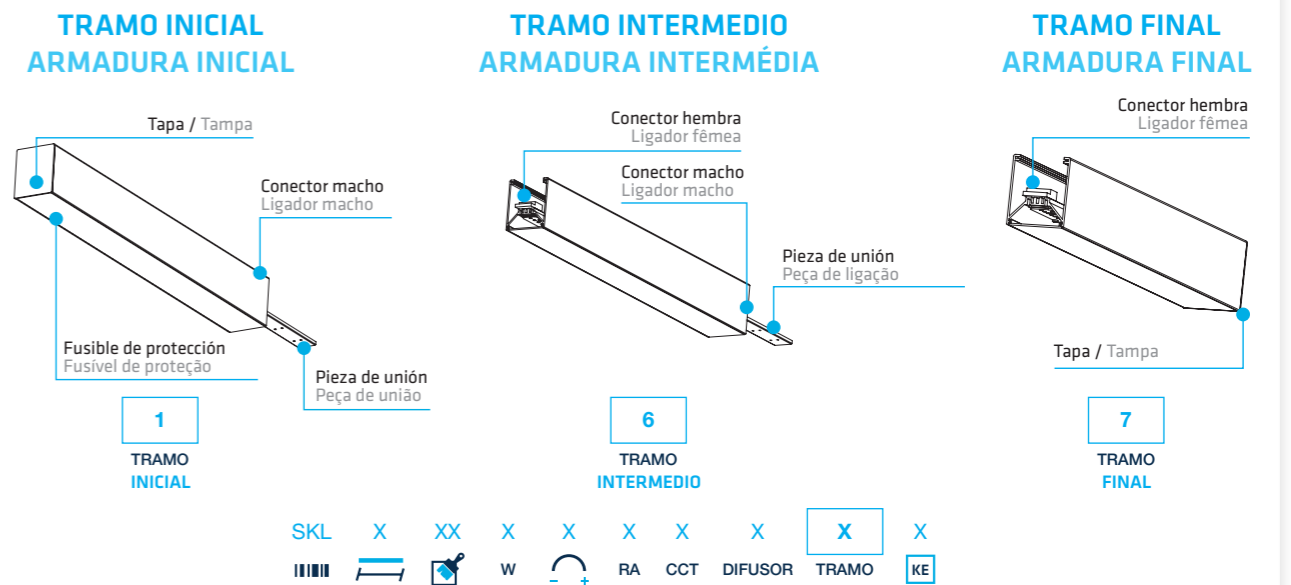

Identifica los tramos de los que se compone tu instalación / Identifique as armaduras que compõem a instalação



Realiza el pedido teniendo en cuenta los tramos / Ao realizar a encomenda, tenha em consideração as armaduras

SKYLINE



SKYLINE 565 mm

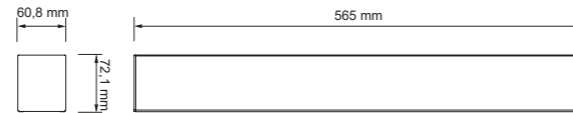

*Genera tu referencia / Gere a sua referência

Icon	Icon	W	RA	CCT	DIFUSOR	TRAMO ARMADURA	KE						
SKYLINE 565 mm	SKL0	00	12 W 1	0	> 80	8	● 6500K 6	OPAL	0	ÚNICO	0	✗	0
		10	25 W 2	1	> 90	9	● 4000K 4	MICROPRIS.	1	INICIAL	1		
		20	35 W 3	2	1-10V	2	● 3000K 3			INTERMEDIO	6		
										FINAL	7		

OPAL	W	CCT	Beam	Beam	W	CCT	Beam	Beam	W	CCT	Beam	Beam		
	12 W	● 6500K	1764 lm	1437 lm	● 4000K	1711 lm	1394 lm	● 3000K	1660 lm	1352 lm	25 W	● 6500K	3675 lm	2875 lm
											● 4000K	3565 lm	2789 lm	
											● 3000K	3458 lm	2705 lm	
											35 W	● 4000K	4991 lm	3904 lm
											● 3000K	4841 lm	3787 lm	
MICROPRIS.	W	CCT	Beam	Beam	W	CCT	Beam	Beam	W	CCT	Beam	Beam		
	12 W	● 6500K	1764 lm	1500 lm	● 4000K	1711 lm	1455 lm	● 3000K	1660 lm	1411 lm	25 W	● 6500K	3675 lm	3000 lm
											● 4000K	3565 lm	2910 lm	
											● 3000K	3458 lm	2823 lm	
											35 W	● 4000K	4991 lm	4074 lm
											● 3000K	4841 lm	3952 lm	

*Otros acabados a consultar / Para outros acabamentos consultar

SKYLINE

SKYLINE 845 mm

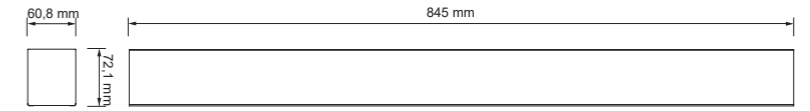

*Genera tu referencia / Gere a sua referência

Icon	Icon	W	RA	CCT	DIFUSOR	TRAMO ARMADURA	KE						
SKYLINE 845 mm	SKL1	01	18,5 W 1	0	> 80	8	● 6500K 6	OPAL	2	ÚNICO	0	✗	0
		11	35 W 2	1	> 90	9	● 4000K 4	MICROPRIS.	3	INICIAL	1	KEU603	8
		21	50 W 3	2	1-10V	2	● 3000K 3			INTERMEDIO	6		
										FINAL	7		

OPAL	W	CCT	Beam	Beam	W	CCT	Beam	Beam	W	CCT	Beam	Beam		
	18,5 W	● 6500K	2720 lm	2127 lm	● 4000K	2638 lm	2063 lm	● 3000K	2559 lm	2001 lm	35 W	● 6500K	5145 lm	4025 lm
											● 4000K	4991 lm	3904 lm	
											● 3000K	4841 lm	3787 lm	
											50 W	● 6500K	7350 lm	5750 lm
											● 4000K	7130 lm	5578 lm	
											● 3000K	6916 lm	5410 lm	
MICROPRIS.	W	CCT	Beam	Beam	W	CCT	Beam	Beam	W	CCT	Beam	Beam		
	18,5 W	● 6500K	2720 lm	2220 lm	● 4000K	2638 lm	2153 lm	● 3000K	2559 lm	2089 lm	35 W	● 6500K	5145 lm	4200 lm
											● 4000K	4991 lm	4074 lm	
											● 3000K	4841 lm	3952 lm	
											50 W	● 6500K	7350 lm	5750 lm
											● 4000K	7130 lm	5578 lm	
											● 3000K	6916 lm	5410 lm	

SKYLINE 1125 mm

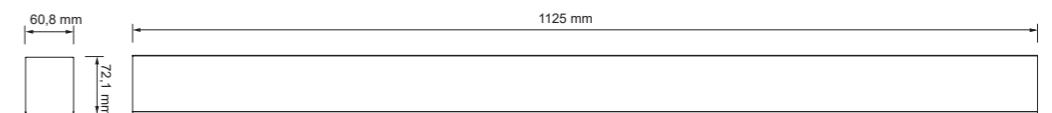

*Genera tu referencia / Gere a sua referência

Icon	Icon	W	RA	CCT	DIFUSOR	TRAMO ARMADURA	KE						
SKYLINE 1125 mm	SKL2	02	25 W 1	0	> 80	8	● 6500K 6	OPAL	4	ÚNICO	0	✗	0
		12	45 W 2	1	> 90	9	● 4000K 4	MICROPRIS.	5	INICIAL	1	KEU603	8
		22	70 W 3	2	1-10V	2	● 3000K 3			INTERMEDIO	6		
										FINAL	7		

OPAL	W	CCT	Beam	Beam	W	CCT	Beam	Beam	W	CCT	Beam	Beam		
	25 W	● 6500K	3675 lm	2875 lm	● 4000K	3308 lm	2588 lm	● 3000K	2977 lm	2329 lm	45 W	● 6500K	7350 lm	5750 lm
											● 4000K	6615 lm	5175 lm	
											● 3000K	5954 lm	4658 lm	
											70 W	● 6500K	10290 lm	8050 lm
											● 4000K	9261 lm	7245 lm	
											● 3000K	8335 lm	6521 lm	
MICROPRIS.	W	CCT	Beam	Beam	W	CCT	Beam	Beam	W	CCT	Beam	Beam		
	25 W	● 6500K	3675 lm	3000 lm	● 4000K	3308 lm	2700 lm	● 3000K	2977 lm	2430 lm	45 W	● 6500K	7350 lm	6000 lm
											● 4000K	6615 lm	5400 lm	
											● 3000K	5954 lm	4860 lm	
											70 W	● 6500K	10290 lm	8400 lm
											● 4000K	9261 lm	7560 lm	
											● 3000K	8335 lm	6804 lm	

*Otros acabados a consultar / Para outros acabamentos consultar

SKYLINE

SKYLINE 1405 mm

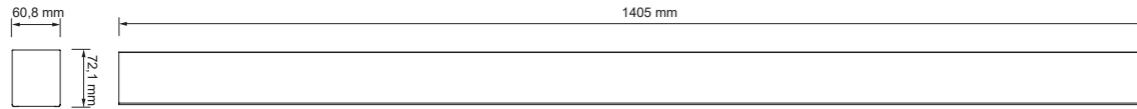

*Genera tu referencia / Gere a sua referência

SKYLINE 1405 mm	SKL3	03	30 W	1	0	> 80	8	6500K	6	OPAL	6	ÚNICO	0	KE	
	13	60 W	2	DALI / PUSH	1	> 90	9	4000K	4	MICROPRIS.	7	INICIAL	1	KEU603	8
	23	90 W	3	1-10V	2			3000K	3			INTERMEDIO	6		
												FINAL	7		

OPAL	W	CCT	n		W	CCT	n		W	CCT	n	
	30 W	6500K	4410 lm	3450 lm	6500K	8820 lm	6900 lm	6500K	13230 lm	10350 lm	4000K	4278 lm
	4000K	4278 lm	3347 lm	4000K	8555 lm	6693 lm	4000K	12833 lm	10040 lm	3000K	4149 lm	3246 lm
	3000K	4149 lm	3246 lm	3000K	8299 lm	6492 lm	3000K	12448 lm	9738 lm			

MICROPRIS.	W	CCT	n		W	CCT	n		W	CCT	n	
	30 W	6500K	4410 lm	3600 lm	6500K	8820 lm	7200 lm	6500K	13230 lm	10800 lm	4000K	4278 lm
	4000K	4278 lm	3492 lm	4000K	8555 lm	6984 lm	4000K	12833 lm	10476 lm	3000K	4149 lm	3387 lm
	3000K	4149 lm	3387 lm	3000K	8299 lm	6774 lm	3000K	12448 lm	10162 lm			

SKYLINE 1685 mm

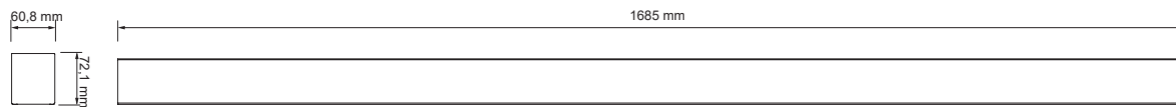

*Genera tu referencia / Gere a sua referência

SKYLINE 1685 mm	SKL4	04	40 W	1	0	> 80	8	6500K	6	OPAL	8	ÚNICO	0	KE	
	14	70 W	2	DALI / PUSH	1	> 90	9	4000K	4	MICROPRIS.	9	INICIAL	1	KEU603	8
	24	105 W	3	1-10V	2			3000K	3			INTERMEDIO	6		
												FINAL	7		

OPAL	W	CCT	n		W	CCT	n		W	CCT	n	
	40 W	6500K	5880 lm	4600 lm	6500K	10290 lm	8050 lm	6500K	15435 lm	12075 lm	4000K	5704 lm
	4000K	5704 lm	4462 lm	4000K	9981 lm	7809 lm	4000K	14972 lm	11713 lm	3000K	5532 lm	4328 lm
	3000K	5532 lm	4328 lm	3000K	9682 lm	7574 lm	3000K	14523 lm	11361 lm			

MICROPRIS.	W	CCT	n		W	CCT	n		W	CCT	n	
	40 W	6500K	5880 lm	4800 lm	6500K	10290 lm	8400 lm	6500K	15435 lm	12600 lm	4000K	5704 lm
	4000K	5704 lm	4656 lm	4000K	9981 lm	8148 lm	4000K	14972 lm	12222 lm	3000K	5532 lm	4516 lm
	3000K	5532 lm	4516 lm	3000K	9682 lm	7904 lm	3000K	14523 lm	11855 lm			

*Otros acabados a consultar / Para outros acabamentos consultar

SKYLINE. ACCESORIOS SUPERFICIE ACESSÓRIOS SUPERFÍCIE

*Genera tu referencia / Gere a sua referência



ASKL	TAMAÑO (Uds. incl.)	ACCESORIO
	565 mm (2 uds.)	0 ECO 0
	845 mm (2 uds.)	1
	1125 mm (2 uds.)	2
	1405 mm (3 uds.)	3
	1685 mm (3 uds.)	4



ASKL01SP

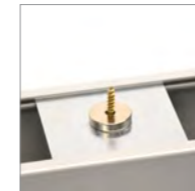

ASKL	TAMAÑO (Uds. incl.)	ACCESORIO
	565 mm (2 uds.)	5 IMÁN 1
	845 mm (3 uds.)	6
	1125 mm (4 uds.)	7
	1405 mm (4 uds.)	8
	1685 mm (5 uds.)	9

Incluye tirantes de seguridad / Inclui tirantes de segurança

SKYLINE. ACCESORIOS SUSPENSIÓN ACESSÓRIOS SUSPENSÃO

*Genera tu referencia / Gere a sua referência

ASKL	TAMAÑO (Uds. incl.)	FIJACIÓN AL TECHO	CABLE (m)	FIJACIÓN AL LINEAL
	565 mm (2 uds.)	0 DEC (Decorativo) 3	1 m 1	AM (Decorativo) 1
	845 mm (2 uds.)	1 HM6 (Hormigón) (Cemento) 4	2 m 2	HF (Eco) 2
	1125 mm (2 uds.)	2 J90 (Madera y chapa) (Madeira e alumínio) 5		
	1405 mm (3 uds.)	3 LAZ (Vigas) 6		
	1685 mm (3 uds.)	4		

*Para otras longitudes de cable consultar. / Para outros tamanhos de cabos consultar.

ASKL	TAMAÑO (Uds. incl.)	SUSPENSIÓN
	565 mm (2 uds.)	0 ECO 2
	845 mm (2 uds.)	1
	1125 mm (2 uds.)	2
	1405 mm (3 uds.)	3
	1685 mm (3 uds.)	4

Fijación al techo
Fixação ao tecto

Fijación al lineal
Fixação linear

*Cable 1,3 m incluido.
Cabo 1,3 m incluído.

Con todos los accesorios de suspensión se incluye tapa trasera / Todos os acessórios de suspensão incluem tampa traseira

TURIA

PREMIUM TLR

6500K 4000K 3000K 198-264Vac 50/60Hz FLICKER FREE

COS φ >0,95 50.000 h x 30.000

IP20 5 AÑOS DE GARANTÍA <19 LOW UGR

100lm/W reales/reais

DRIVER TRIDONIC

• Material

AL PC PRISM PC OPAL

CUERPO DIFUSOR DIFUSOR

• Opciones

BL PL NE

RAL 9016 RAL 9006 RAL 9005

570 mm 850 mm 1130 mm 1410 mm 1690 mm

• Opc. de Reg.

DALI PUSH

0-10V 0-10V/DA

Ref. MDRF Ref. CSB110DA

• Opcional



• Certif.

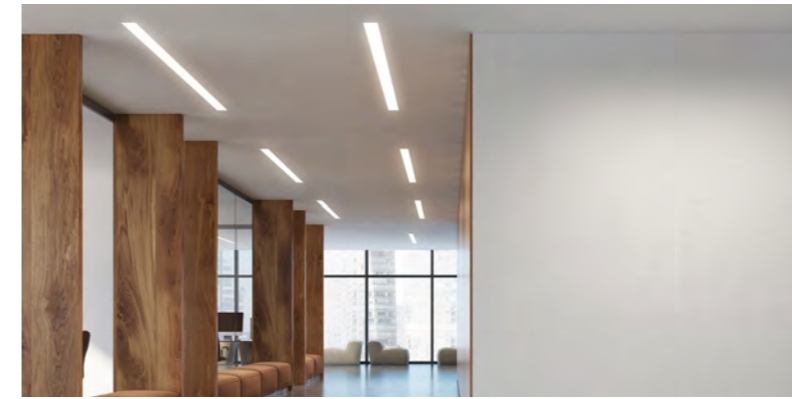
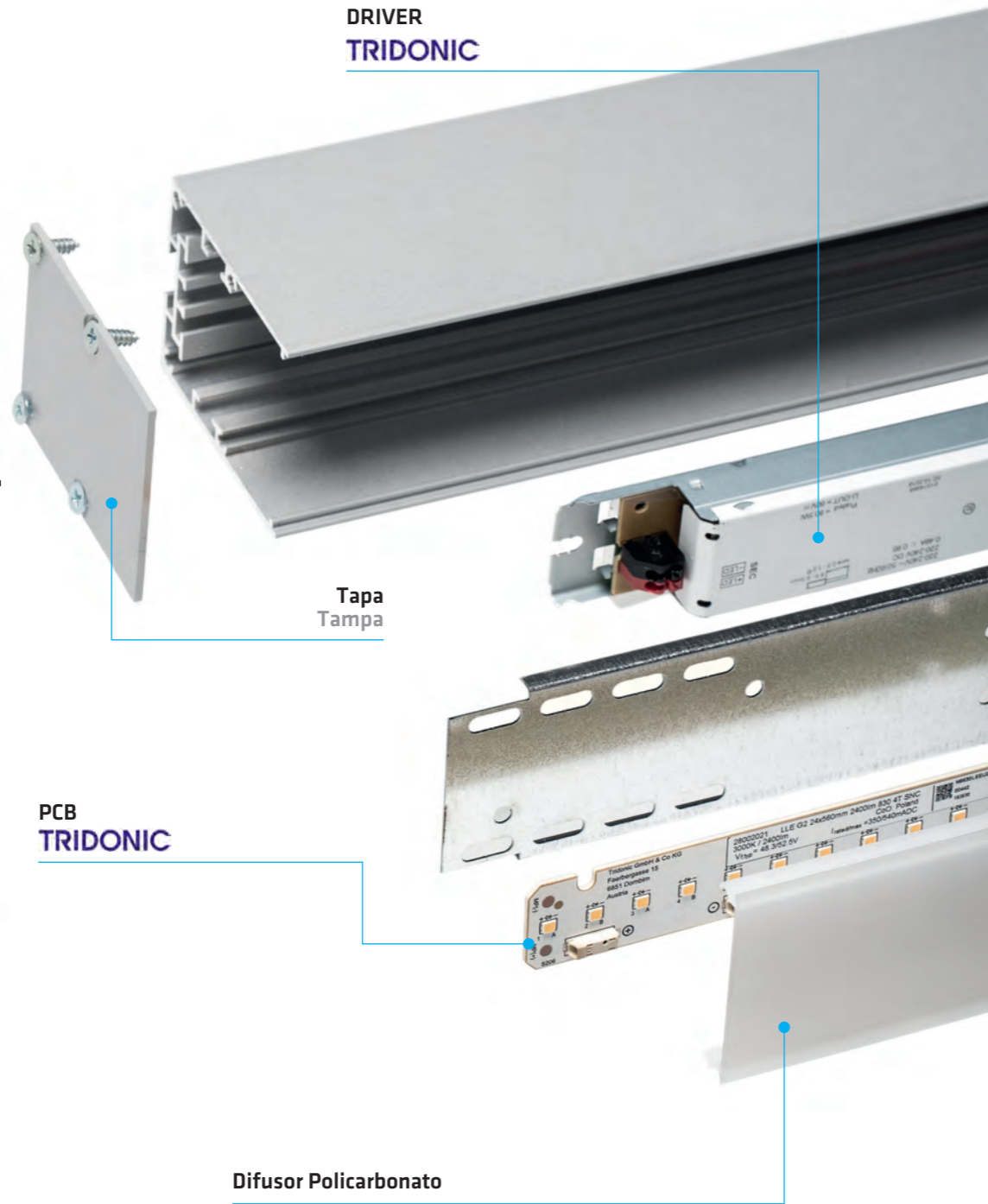

ILUMINACIÓN EMPOTRADA
ILUMINAÇÃO DE ENCASTRAR

ILUMINACIÓN DESDE PARED
ILUMINAÇÃO A PARTIR DA PAREDE



ILUMINACIÓN DIRECTA + INDIRECTA
ILUMINAÇÃO DIRETA + INDIRETA

ILUMINACIÓN EN SUPERFICIE
ILUMINAÇÃO EM SUPERFÍCIE

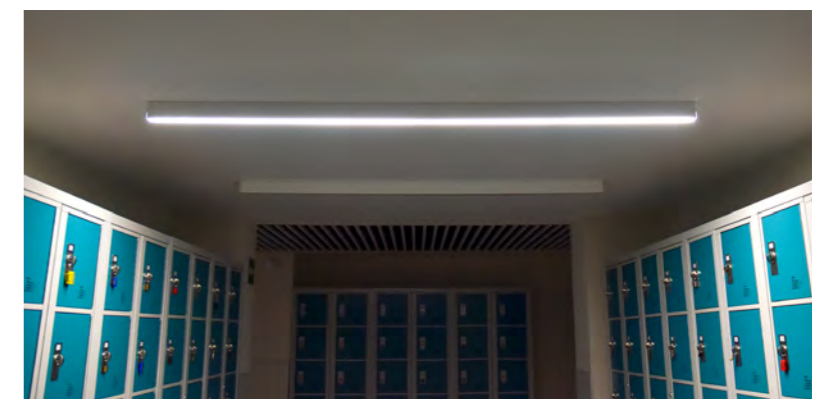

TURIA. SUPERFICIE / SUPERFÍCIE

*(Clips de fijación al techo incluidos) / (Clips de fixação ao tecto incluídos)



TLR570

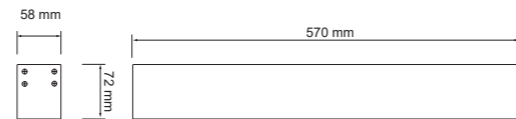

*Genera tu referencia / Gere a sua referência

OPAL	W	*	CCT	OPAL	W	*	CCT
TURIA 570 mm	12 W	12W	6500K	TLR570-	12 W	12W	6500K
	25 W	25W	4000K		25 W	25W	4000K
	35 W	35W	3000K		35 W	35W	3000K

* Opcional: UE DRIVER, D110 1-10V, DOD DALI / PUSH

OPAL	W	CCT	Beam	Beam	OPAL	W	CCT	Beam	Beam	OPAL	W	CCT	Beam	Beam
12 W	6500K	1764 lm	1176 lm		25 W	6500K	3675 lm	2450 lm		35 W	6500K	5145 lm	3430 lm	
	4000K	1711 lm	1141 lm			4000K	3565 lm	2377 lm			4000K	4991 lm	3327 lm	
	3000K	1660 lm	1106 lm			3000K	3458 lm	2305 lm			3000K	4841 lm	3227 lm	

*Otros acabados a consultar / Para outros acabamentos consultar

TURIA. SUPERFICIE / SUPERFÍCIE

TLR850

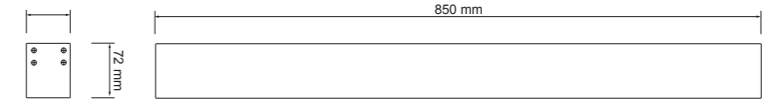

*Genera tu referencia / Gere a sua referência

OPAL	W	*	CCT	MICROPRIS.	W	*	CCT
TURIA 850 mm	18,5 W	18.5W	6500K	TLR850M-	18,5 W	18.5W	6500K
	35 W	35W	4000K		35 W	35W	4000K
	50 W	50W	3000K		50 W	50W	3000K

* Opcional: UE DRIVER, D110 1-10V, DOD DALI / PUSH

OPAL	W	CCT	Beam	Beam	OPAL	W	CCT	Beam	Beam	OPAL	W	CCT	Beam	Beam
18,5 W	6500K	2716 lm	1811 lm		35 W	6500K	5145 lm	3430 lm		50 W	6500K	7305 lm	4870 lm	
	4000K	2634 lm	1757 lm			4000K	4991 lm	3327 lm			4000K	7087 lm	4724 lm	
	3000K	2556 lm	1703 lm			3000K	4841 lm	3227 lm			3000K	6874 lm	4582 lm	

TLR1130

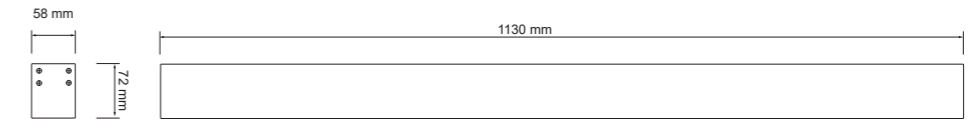

*Genera tu referencia / Gere a sua referência

OPAL	W	*	CCT	MICROPRIS.	W	*	CCT
TURIA 1130 mm	25 W	25W	6500K	TLR1130M-	25 W	25W	6500K
	50 W	50W	4000K		50 W	50W	4000K
	70 W	70W	3000K		70 W	70W	3000K

* Opcional: UE DRIVER, D110 1-10V, DOD DALI / PUSH

OPAL	W	CCT	Beam	Beam	OPAL	W	CCT	Beam	Beam	OPAL	W	CCT	Beam	Beam
25 W	6500K	3675 lm	2450 lm		50 W	6500K	7350 lm	4900 lm		70 W	6500K	10290 lm	6860 lm	
	4000K	3308 lm	2377 lm			4000K	6615 lm	4753 lm			4000K	9261 lm	6654 lm	
	3000K	2977 lm	2305 lm			3000K	5954 lm	4610 lm			3000K	8335 lm	6455 lm	

*Otros acabados a consultar / Para outros acabamentos consultar

TURIA. SUPERFICIE / SUPERFÍCIE

TLR1410

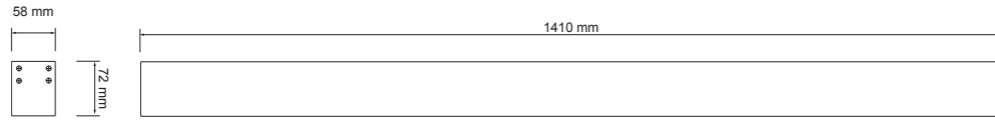

*Genera tu referencia / Gere a sua referência

OPAL	W	*	CCT	OPAL	W	*	CCT
TURIA 1410 mm	30 W	30W	6500K	BF	30 W	30W	6500K
	60 W	60W	4000K	BN	60 W	60W	4000K
	90 W	90W	3000K	BC	90 W	90W	3000K

* Opcional:

* Opcional:

OPAL	W	CCT	Beam	OPAL	W	CCT	Beam	MICROPRIS.	W	CCT	Beam	MICROPRIS.	W	CCT	Beam
30 W	6500K	4410 lm	2940 lm	60 W	6500K	8820 lm	5880 lm	30 W	6500K	13230 lm	8820 lm	30 W	6500K	4410 lm	3000 lm
	4000K	4277 lm	2852 lm		4000K	8556 lm	5704 lm		4000K	12831 lm	8556 lm		4000K	4277 lm	2910 lm
	3000K	4150 lm	2765 lm		3000K	8300 lm	5532 lm		3000K	12450 lm	8295 lm		3000K	4150 lm	2822 lm

TLR1690

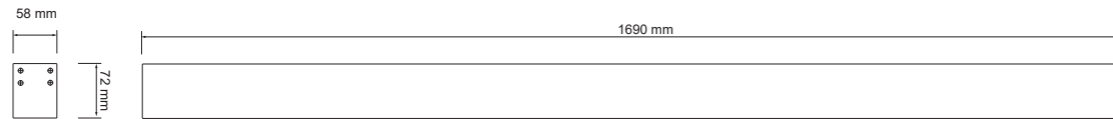

*Genera tu referencia / Gere a sua referência

OPAL	W	*	CCT	OPAL	W	*	CCT
TURIA 1690 mm	40 W	40W	6500K	BF	40 W	40W	6500K
	75 W	75W	4000K	BN	75 W	75W	4000K
	105 W	105W	3000K	BC	105 W	105W	3000K

* Opcional:

* Opcional:

OPAL	W	CCT	Beam	OPAL	W	CCT	Beam	MICROPRIS.	W	CCT	Beam	MICROPRIS.	W	CCT	Beam
40 W	6500K	5880 lm	4900 lm	75 W	6500K	10290 lm	7350 lm	40 W	6500K	15435 lm	10290 lm	40 W	6500K	5880 lm	5000 lm
	4000K	5704 lm	4753 lm		4000K	9981 lm	7130 lm		4000K	14972 lm	9981 lm		4000K	5704 lm	4850 lm
	3000K	5532 lm	4610 lm		3000K	9682 lm	6916 lm		3000K	14523 lm	9682 lm		3000K	5532 lm	4705 lm

*Otros acabados a consultar / Para outros acabamentos consultar

TURIA. EMPOTRAR / ENCASTRAR



TLRE570

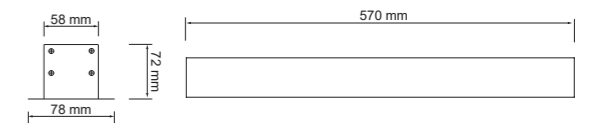

*Genera tu referencia / Gere a sua referência

OPAL	W	*	CCT	OPAL	W	*	CCT
TURIA 570 mm	12 W	12W	6500K	BF	12 W	12W	6500K
	25 W	25W	4000K	BN	25 W	25W	4000K
	35 W	35W	3000K	BC	35 W	35W	3000K

* Opcional:

* Opcional:

OPAL	W	CCT	Beam	OPAL	W	CCT	Beam	MICROPRIS.	W	CCT	Beam	MICROPRIS.	W	CCT	Beam
12 W	6500K	1764 lm	1176 lm	25 W	6500K	3675 lm	2450 lm	12 W	6500K	5145 lm	3430 lm	12 W	6500K	1764 lm	1200 lm
	4000K	1711 lm	1141 lm		4000K	3565 lm	2377 lm		4000K	4991 lm	3327 lm		4000K	1711 lm	1164 lm
	3000K	1660 lm	1106 lm		3000K	3458 lm	2305 lm		3000K	4841 lm	3227 lm		3000K	1660 lm	1129 lm

*Otros acabados a consultar / Para outros acabamentos consultar

TURIA. EMPOTRAR / ENCASTRAR

TLRE850

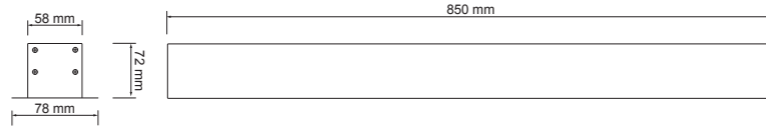

*Genera tu referencia / Gere a sua referência

OPAL	W	*	CCT	MICROPRIS.	W	*	CCT
TURIA 850 mm TLRE850-	18,5 W	18W	6500K	TURIA 850 mm TLRE850M-	18,5 W	18W	6500K
	35 W	35W	4000K		35 W	35W	4000K
	50 W	50W	3000K		50 W	50W	3000K

* Opcional: UE DRIVER, D110 1-10V, DOD DALI / PUSH

OPAL	W	CCT	Beam	Beam	MICROPRIS.	W	CCT	Beam	Beam
18,5 W	6500K	2716 lm	1811 lm		35 W	6500K	5145 lm	3430 lm	
	4000K	2634 lm	1757 lm	4000K		4991 lm	3327 lm		
	3000K	2556 lm	1703 lm	3000K		4841 lm	3227 lm		
50 W	6500K	7305 lm	4870 lm	50 W	6500K	7305 lm	4870 lm		
	4000K	7087 lm	4724 lm		4000K	7087 lm	4724 lm		
	3000K	6874 lm	4582 lm		3000K	6874 lm	4582 lm		

TLRE1130

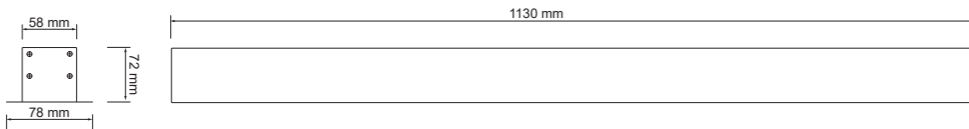

*Genera tu referencia / Gere a sua referência

OPAL	W	*	CCT	MICROPRIS.	W	*	CCT
TURIA 1130 mm TLRE1130-	25 W	25W	6500K	TURIA 570 mm TLRE1130M-	25 W	25W	6500K
	50 W	50W	4000K		50 W	50W	4000K
	70 W	70W	3000K		70 W	70W	3000K

* Opcional: UE DRIVER, D110 1-10V, DOD DALI / PUSH

OPAL	W	CCT	Beam	Beam	MICROPRIS.	W	CCT	Beam	Beam
25 W	6500K	3675 lm	2450 lm		50 W	6500K	7350 lm	4900 lm	
	4000K	3308 lm	2377 lm	4000K		6615 lm	4753 lm		
	3000K	2977 lm	2305 lm	3000K		5954 lm	4610 lm		
70 W	6500K	10290 lm	6860 lm	70 W	6500K	10290 lm	6860 lm		
	4000K	9261 lm	6654 lm		4000K	9261 lm	6654 lm		
	3000K	8335 lm	6455 lm		3000K	8335 lm	6455 lm		

*Otros acabados a consultar / Para outros acabamentos consultar

TURIA. EMPOTRAR / ENCASTRAR

TLRE1410

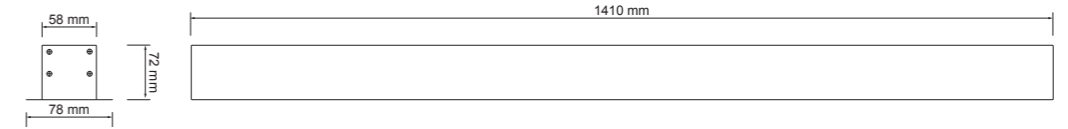

*Genera tu referencia / Gere a sua referência

OPAL	W	*	CCT	MICROPRIS.	W	*	CCT
TURIA 1410 mm TLRE1410-	30 W	30W	6500K	TURIA 1410 mm TLRE1410M-	30 W	30W	6500K
	60 W	60W	4000K		60 W	60W	4000K
	90 W	90W	3000K		90 W	90W	3000K

* Opcional: UE DRIVER, D110 1-10V, DOD DALI / PUSH

OPAL	W	CCT	Beam	Beam	MICROPRIS.	W	CCT	Beam	Beam
30 W	6500K	4410 lm	2940 lm		60 W	6500K	8820 lm	5880 lm	
	4000K	4277 lm	2852 lm	4000K		8556 lm	5704 lm		
	3000K	4150 lm	2765 lm	3000K		8300 lm	5532 lm		
90 W	6500K	13230 lm	8820 lm	90 W	6500K	13230 lm	8820 lm		
	4000K	12831 lm	8556 lm		4000K	12831 lm	8556 lm		
	3000K	12450 lm	8295 lm		3000K	12450 lm	8295 lm		

TLRE1690

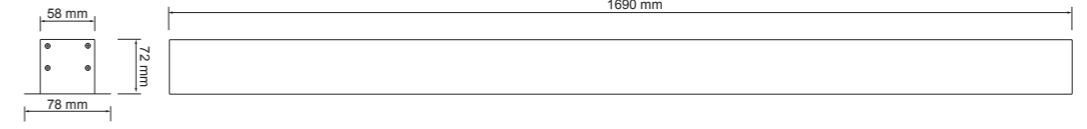

*Genera tu referencia / Gere a sua referência

OPAL	W	*	CCT	MICROPRIS.	W	*	CCT
TURIA 1690 mm TLRE1690-	40 W	40W	6500K	TURIA 1690 mm TLRE1690M-	40 W	40W	6500K
	75 W	75W	4000K		75 W	75W	4000K
	105 W	105W	3000K		105 W	105W	3000K

* Opcional: UE DRIVER, D110 1-10V, DOD DALI / PUSH

OPAL	W	CCT	Beam	Beam	MICROPRIS.	W	CCT	Beam	Beam
40 W	6500K	4880 lm	3900 lm		75 W	6500K	10290 lm	7350 lm	
	4000K	4704 lm	3753 lm	4000K		9981 lm	7130 lm		
	3000K	4532 lm	3610 lm	3000K		9682 lm	6916 lm		
105 W	6500K	15435 lm	10290 lm	105 W	6500K	15435 lm	10290 lm		
	4000K	14972 lm	9981 lm		4000K	14972 lm	9981 lm		
	3000K	14523 lm	9682 lm		3000K	14523 lm	9682 lm		

TURIA. ACCESORIOS SUSPENSIÓN ACESSÓRIOS SUSPENSÃO

*Genera tu referencia / Gere a sua referência

TAMAÑO (Uds. incl.)	FIJACIÓN AL TECHO	CABLE (m)	FIJACIÓN AL LINEAL
570 mm (2 uds.)	DEC (Decorativo) 3	1 m 1	DISC (Decorativo) 3
1130 mm (2 uds.)	HM6 (Hormigón) (Cemento) 4	2 m 2	HF (Eco) 4
1690 mm (3 uds.)	J90 (Madera y chapa) (Madeira e alumínio) 5		
	LAZ (Vigas) 6		

*Para otras longitudes de cable consultar. / Para outros tamanhos de cabos consultar.

FIJACIÓN AL TECHO	CABLE (m)
DEC 3	1 m 1
HM6 4	2 m 2
J90 5	
LAZ 6	

TURIA. ACCESORIOS / ACESSÓRIOS

Kit de unión (2 uds.)
Kit acessório de união (2 un.)

Ref. **AUTLR**

Embelecedor para unión (1ud.)
Embeleizador para união (1 un.)

- Ref. **AOUTLR_2VBL**
- Ref. **AOUTLR_2VPL**
- Ref. **AOUTLR_2VNE**

Escuadra 40° (1 ud.)
Esquadria 40° (1 un.)

- Ref. **AES40TLRBL**
- Ref. **AES40TLRPL**
- Ref. **AES40TLRNE**

Escuadra 90° (1 ud.)
Esquadria 90° (1 un.)

- Ref. **AES90TLRBL**
- Ref. **AES90TLRPL**
- Ref. **AES90TLRNE**

Tapas para fijación en pared (2 uds.)
Embeleizador para união (1 un.)

- Ref. **ATPTLRBL**
- Ref. **ATPTLRPL**
- Ref. **ATPTLRNE**

*Consultar otras formas de instalación / Consultar outras formas de instalação

Luz indirecta
Luz indireta

	6000K	4000K	2700K
570 mm	ALITLR570BF	ALITLR570BN	ALITLR570BC
1130 mm	ALITLR1130BF	ALITLR1130BN	ALITLR1130BC
1690 mm	ALITLR1690BF	ALITLR1690BN	ALITLR1690BC

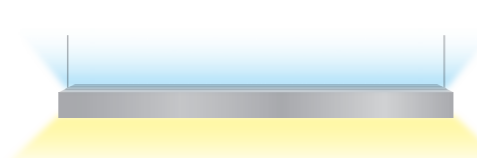

SKYLINE vs TURIA. EJEMPLOS / EXEMPLOS

TURIA

Lineal TURIA de 1130 mm opal, 25W, 4000K, acabado blanco, DALI.
Linear TURIA de 1130 mm opal, 25W, 4000K, acabamento branco, DALI.

OPAL	W	* CCT	RA	FA	CCT	DIFUSOR	TRAMO ARMADURA	KE
TURIA 1130 mm	TLR1130-	25 W	25W	6500K	BF	BL	ÚNICO	0
		50 W	50W	4000K	BN	PL	INICIAL	1
		70 W	70W	3000K	BC	NE	INTERMEDIO	6
							FINAL	7

Ref. **TLR1130-25WDDBNBL**

* Opcional: UE DRIVER, DOD (DALI / PUSH)

SKYLINE

Tramo único con SKYLINE de 1125 mm, microprismático, 25W, 3000K y acabado gris con regulación DALI.
Armadura única com SKYLINE de 1125 mm, microprismático, 25W, 3000K e acabamento cinza com regulação DALI.

TRAMO ÚNICO (0)

SKYLINE	W	RA	FA	CCT	DIFUSOR	TRAMO ARMADURA	KE					
SKYLINE 1125 mm	SKL2	02	25 W	1	6500K	6	OPAL	4	ÚNICO	0	X	0
		12	45 W	2	4000K	4	MICROPRIS.	5	INICIAL	1	KEU603	8
		22	70 W	3	3000K	3			INTERMEDIO	6		
									FINAL	7		

Ref. **SKL2121183500**

SKYLINE

Línea continua SKYLINE de 1685 mm opal, 70W, 4000K y acabado blanco.
Linha continua SKYLINE de 1685 mm opal, 70W, 4000K e acabamento branco.

TRAMO INICIAL (1) | TRAMO INTERMEDIO (6) | TRAMO FINAL (7)

SKYLINE	W	RA	FA	CCT	DIFUSOR	TRAMO ARMADURA	KE					
SKYLINE 1685 mm	SKL4	04	40 W	1	6500K	6	OPAL	8	ÚNICO	0	X	0
		14	70 W	2	4000K	4	MICROPRIS.	9	INICIAL	1	KEU603	8
		24	105 W	3	3000K	3			INTERMEDIO	6		
									FINAL	7		

TRAMO INICIAL (1) Ref. **SKL4042084810**

TRAMO INTERMEDIO (6) Ref. **SKL4042084860**

TRAMO FINAL (7) Ref. **SKL4042084870**

NEW
ALTHEA

PRO LTS

5000K 4000K 3000K 220-240Vac 50/60 Hz FLICKER FREE

CRI >80 cos φ >0,9 50.000 h x 25.000

IP20 5 AÑOS DE GARANTÍA PL RAL 7047 DI

• Material • Certif.

AL PMMA CUERPO DIFUSOR CE

• Opc. de Reg.

0/1-10V DALI PUSH 0-10V/DA Ref. CSB110DA 0-10V/DA Ref. ZIGBEE-010V

150lm/W reales/reais

Conexión rápida
Ligação rápida

Cuerpo en aluminio
Corpo em alumínio

Difusor PMMA
Difusor PMMA

Fácil unión entre lineales
Fácil ligação entre lineares

Variedad de lentes para diferentes aplicaciones
Variedade de lentes para diferentes aplicações

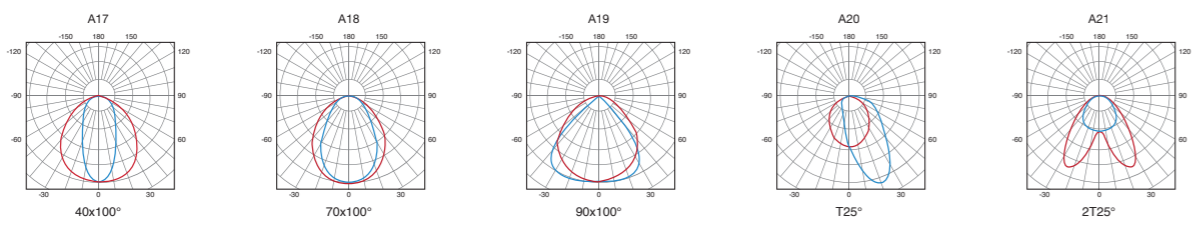

ALTHEA. ACCESORIOS / ACESSÓRIOS



Accesorio de suspensión
Acessório de suspensão



Accesorio de superficie
Acessório de superfície



Tapas finales
Tampas de remate

ALTHEA

PRO LTS40 / LTS60 / LTS75

5000K 4000K 3000K 220-240Vac 50/60 Hz FLICKER FREE

CRI >80 cos φ >0,9 50.000 h x 25.000

IP20 5 AÑOS DE GARANTÍA PL RAL 7047 DI

• Material • Certif.

AL PMMA CUERPO DIFUSOR CE

• Opc. de Reg.

0/1-10V DALI PUSH 0-10V/DA Ref. CSB110DA 0-10V/DA Ref. ZIGBEE-010V



150lm/W reales
150lm/W reais

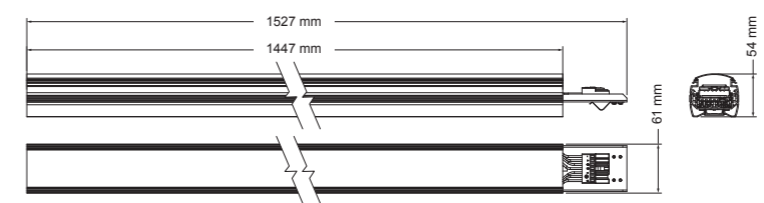

Model	OPCIONAL	W	CCT	lm	lm
LTS4050	*	40 W	5000K	7200 lm	6400 lm
LTS4040	*	40 W	4000K	7200 lm	6400 lm
LTS4030	*	40 W	3000K	7080 lm	6280 lm
LTS6050	*	60 W	5000K	10200 lm	9000 lm
LTS6040	*	60 W	4000K	10200 lm	9000 lm
LTS6030	*	60 W	3000K	10020 lm	8820 lm
LTS7550	*	75 W	5000K	12750 lm	11250 lm
LTS7540	*	75 W	4000K	12750 lm	11250 lm
LTS7530	*	75 W	3000K	12525 lm	11025 lm

* Opc. de Lente

A17 40x100° A18 70x100° A19 90x100°

A20 T25° A21 2T25°

** Opc. de Reg.

D1 0/1-10V D2 DALI / PUSH

Lámparas Lâmpadas



DOWNLIGHTS
DOWNLIGHTS

PLAFONES
PLAFONS

PANELES
PAINÉIS

LINEALES
LINEARES

LÁMPARAS
LÂMPADAS

TUBOS
TUBOS

LITIO



PALADIO



ZINC



PLUTONIO



GOLD



GALIO



HELIO



PLOMO



RADON



PLATINO



CROMO



GU10



LITIO

PRO LN5W GU10 / LN7W GU10

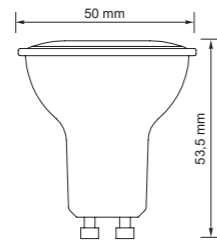
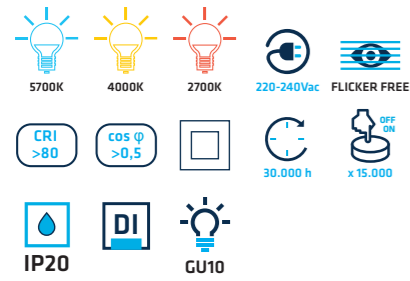

- Material: PC (DIFUSOR), PC (CUERPO), AL (INTERIOR)
- Opcional: KE (Ref. KEL101)
- Certif.: CE
- Accesorio: CONECTOR GU10 (x100)

	CCT	W	120°	60°
LN5WGU10BF120	5700K	5 W	625 lm	500 lm
LN5WGU10BN120	4000K	5 W	615 lm	490 lm
LN5WGU10BC120	2700K	5 W	600 lm	480 lm
LN7WGU10BF120	5700K	7 W	875 lm	770 lm
LN7WGU10BN120	4000K	7 W	861 lm	760 lm
LN7WGU10BC120	2700K	7 W	840 lm	750 lm

	CCT	W	60°	30°
LN5WGU10BF60	5700K	5 W	625 lm	500 lm
LN5WGU10BN60	4000K	5 W	615 lm	490 lm
LN5WGU10BC60	2700K	5 W	600 lm	480 lm
LN7WGU10BF60	5700K	7 W	875 lm	770 lm
LN7WGU10BN60	4000K	7 W	861 lm	760 lm
LN7WGU10BC60	2700K	7 W	840 lm	750 lm

LITIO

PRO LN5W GU5.3

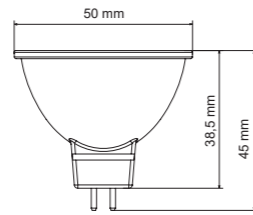
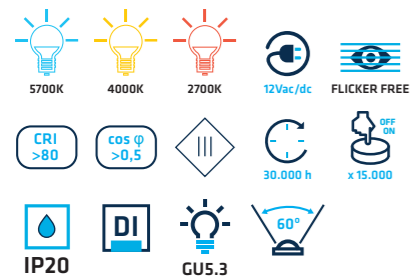

- Material: PC (DIFUSOR), PC (CUERPO), AL (INTERIOR)
- Certif.: CE

	CCT	W	60°	30°
LN5WGU5.3BF60	5700K	5 W	625 lm	500 lm
LN5WGU5.3BN60	4000K	5 W	615 lm	490 lm
LN5WGU5.3BC60	2700K	5 W	600 lm	480 lm

LITIO

PRO LN7WD

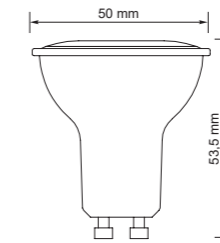
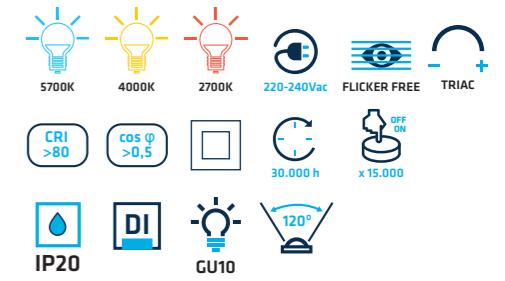

- Material: PC (DIFUSOR), PC (CUERPO), AL (INTERIOR)
- Opc. de Regul.: Ref. CSBTRIAC

	CCT	W	120°	60°
LN7WDGU10BF120	5700K	7 W	875 lm	770 lm
LN7WDGU10BN120	4000K	7 W	861 lm	760 lm
LN7WDGU10BC120	2700K	7 W	840 lm	750 lm

- Opcional: KE (Ref. KEL101)
- Certif.: CE
- Accesorio: CONECTOR GU10 (x100)

LITIO

ECO LC5W

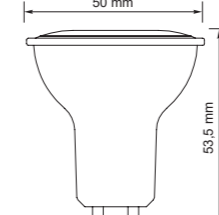
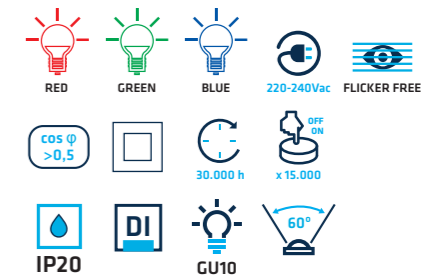

- Material: PC (DIFUSOR), PC (CUERPO)
- Certif.: CE

	CCT	W
LC5WGU10RO	625-650 nm	5 W
LC5WGU10VE	500-540 nm	5 W
LC5WGU10AZ	440-480 nm	5 W

- Accesorio: CONECTOR GU10 (x100)

ZINC

PRO GN45 E14

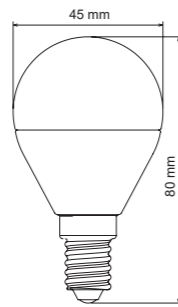
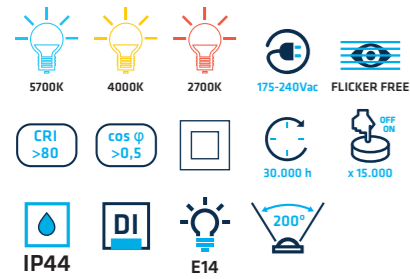

IIIIII	CCT	W	⏚	⏚
GN45-5WE14BF	5700K	5 W	650 lm	550 lm
GN45-5WE14BC	2700K	5 W	630 lm	530 lm
GN45-7WE14BF	5700K	7 W	910 lm	700 lm
GN45-7WE14BN	4000K	7 W	900 lm	690 lm
GN45-7WE14BC	2700K	7 W	890 lm	680 lm

IIIIII	CCT	W	⏚	⏚
GN45-7WDE14BF	5700K	7 W	910 lm	700 lm
GN45-7WDE14BN	4000K	7 W	900 lm	690 lm
GN45-7WDE14BC	2700K	7 W	890 lm	680 lm

ZINC

PRO GN45 E27

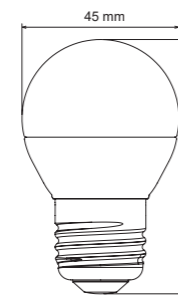
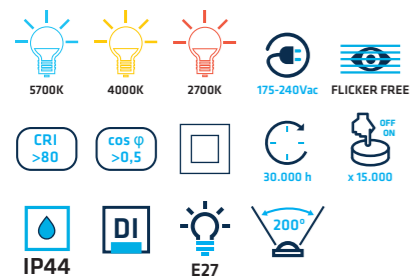

IIIIII	CCT	W	⏚	⏚
GN45-5WE27BF	5700K	5 W	650 lm	550 lm
GN45-5WE27BC	2700K	5 W	630 lm	530 lm
GN45-7WE27BF	5700K	7 W	910 lm	700 lm
GN45-7WE27BN	4000K	7 W	900 lm	690 lm
GN45-7WE27BC	2700K	7 W	890 lm	680 lm

IIIIII	CCT	W	⏚	⏚
GN45-7WDE27BF	5700K	7 W	910 lm	700 lm
GN45-7WDE27BN	4000K	7 W	900 lm	690 lm
GN45-7WDE27BC	2700K	7 W	890 lm	680 lm

- Material: PC OPAL, PC, AL
- Opc. de Regul.: Ref. CSBTRIAC GN45-7WD, TRIAC
- Opcional: KE, Ref. KEL101
- Certif.: CE

ZINC

PRO STDN12W E27

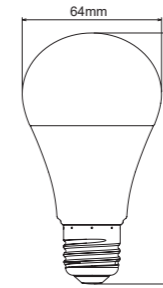
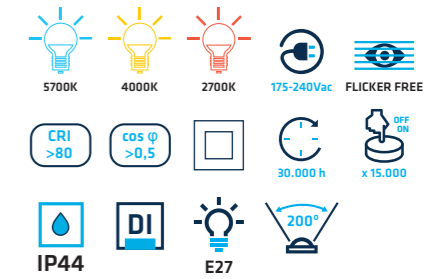

IIIIII	CCT	W	⏚	⏚
STDN12WDE27BF	5700K	12 W	1560 lm	1320 lm
STDN12WDE27BN	4000K	12 W	1550 lm	1310 lm
STDN12WDE27BC	2700K	12 W	1540 lm	1300 lm

- Material: PC OPAL, PC, AL
- Opc. de Regul.: Ref. CSBTRIAC, TRIAC

- Certif.: CE, x50

IIIIII	CCT	W	⏚	⏚
STDN12WE27BF	5700K	12 W	1560 lm	1320 lm
STDN12WE27BN	4000K	12 W	1550 lm	1310 lm
STDN12WE27BC	2700K	12 W	1540 lm	1300 lm

ZINC

PRO GN37V E14

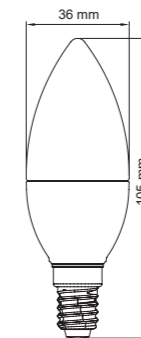
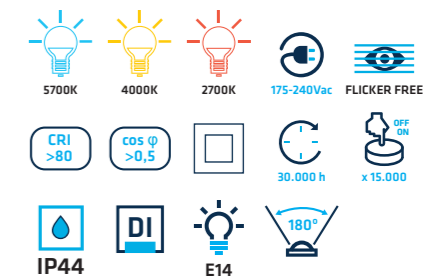

IIIIII	CCT	W	⏚	⏚
GN37V-5WE14BF	5700K	5 W	650 lm	550 lm
GN37V-5WE14BC	2700K	5 W	630 lm	530 lm
GN37V-7WE14BF	5700K	7 W	910 lm	700 lm
GN37V-7WE14BN	4000K	7 W	900 lm	690 lm
GN37V-7WE14BC	2700K	7 W	890 lm	680 lm

- Material: PC OPAL, PC, AL
- Opcional: KE, Ref. KEL101

- Certif.: CE, x100

GOLD



GOLD

PRO GOLD45

- 2500K
- 220-240Vac
- CRI >80
- cos φ >0,5
- 30.000 h
- x15.000
- IP40
- DI
- 300°



• Material • Certif.

V DIFUSOR CE x100

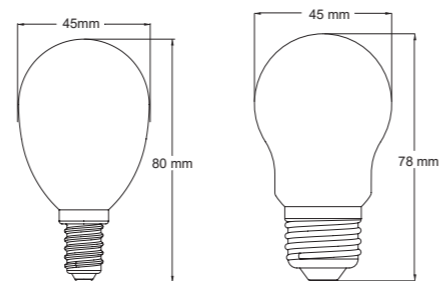

GOLD45-4W E14 GOLD45-4W E27

	CCT	W	lm	lm
GOLD45-4WE14BC	2500K	4 W	590 lm	430 lm
GOLD45-4WE27BC	2500K	4 W	590 lm	430 lm

GOLD

PRO GOLD37V / GOLD60

- 2500K
- 220-240Vac
- CRI >80
- cos φ >0,5
- 30.000 h
- x15.000
- IP40
- DI
- 300°

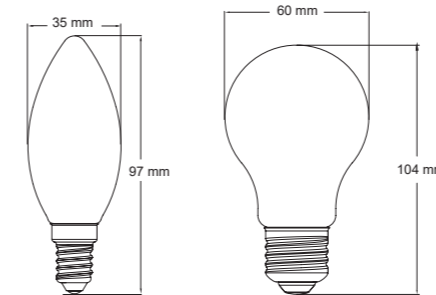

GOLD37V-4W E14 GOLD60-6W E27

• Material • Certif.

V DIFUSOR CE x100

	CCT	W	lm	lm
GOLD37V-4WE14BC	2500K	4 W	600 lm	440 lm
GOLD60-6WE27BC	2500K	6 W	900 lm	730 lm

GOLD

PRO GOLD64 / GOLD95

- 2500K
- 220-240Vac
- CRI >80
- cos φ >0,5
- 30.000 h
- x15.000
- IP40
- DI
- 300°



• Material • Certif.

V DIFUSOR CE x80 x40

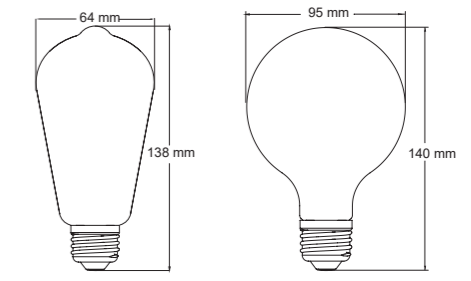

GOLD64-6W E27 GOLD95-6W E27

	CCT	W	lm	lm
GOLD64-6WE27BC	2500K	6 W	950 lm	810 lm
GOLD95-6WE27BC	2500K	6 W	910 lm	750 lm

HELIO

PRO B80 / B95 / B120

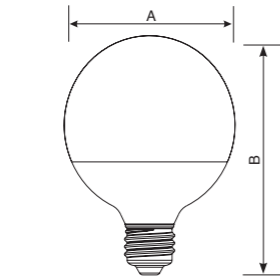
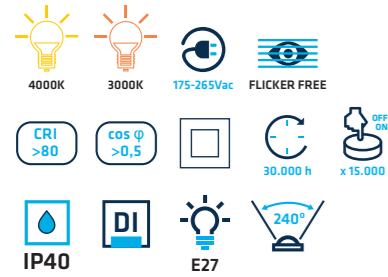

	A	B
B80	80 mm	116 mm
B95	94 mm	132 mm
B120	120 mm	158 mm



• Material • Opcional



	CCT	W	☀	☀
B80-9WE27BN	● 4000K	9 W	1080 lm	936 lm
B80-9WE27BC	● 3000K	9 W	1062 lm	888 lm
B95-13WE27BN	● 4000K	13 W	1560 lm	1360 lm
B95-13WE27BC	● 3000K	13 W	1534 lm	1310 lm
B120-16WE27BN	● 4000K	16 W	1920 lm	1536 lm
B120-16WE27BC	● 3000K	16 W	1888 lm	1465 lm

RADON

PRO R80 / R90

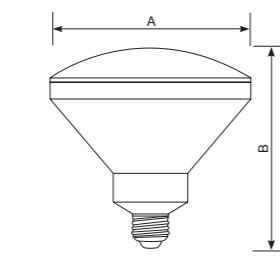
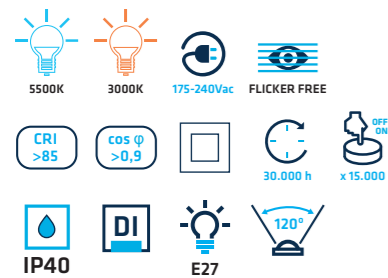

	A	B
R80	79 mm	105 mm
R90	89 mm	107 mm



• Material • Opcional



	CCT	W	☀	☀
R8010WE27BF	● 5500K	9 W	1080 lm	890 lm
R8010WE27BC	● 3000K	9 W	1035 lm	730 lm
R9010WE27BF	● 5500K	9 W	1080 lm	828 lm
R9010WE27BC	● 3000K	9 W	1035 lm	671 lm

CROMO

ECO QR111N13

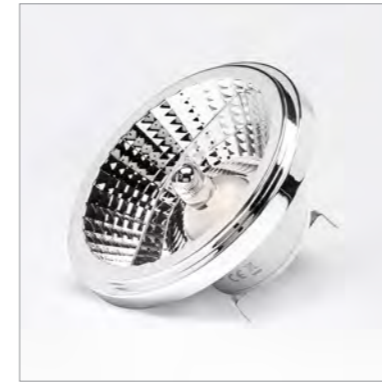
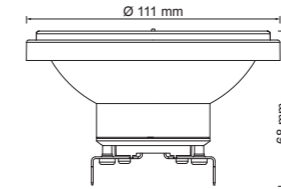
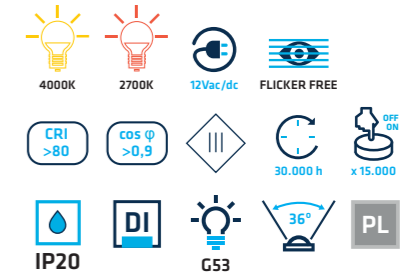

• Material



	CCT	W	☀	☀
QR111N13G53BN	● 4000K	13 W	1560 lm	1300 lm
QR111N13G53BC	● 2700K	13 W	1534 lm	1274 lm

CROMO

ECO QR111N13D

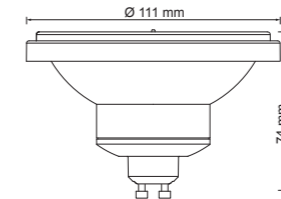
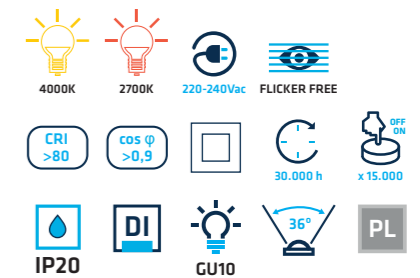

• Material • Opc. de Reg.



	CCT	W	☀	☀
QR111N13DGU10BN	● 4000K	13 W	1560 lm	1300 lm
QR111N13DGU10BC	● 2700K	13 W	1534 lm	1274 lm

PALADIO

PRO PL20E G24 / PL40E G24

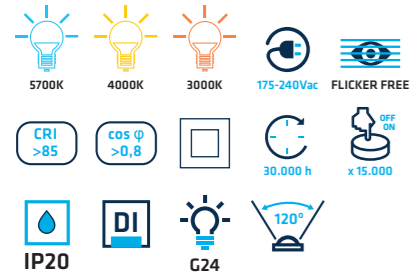

• Material • Opcional

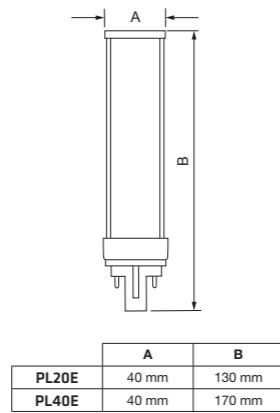

IIIII	CCT	W	N	☀
PL20EG24BF	5700K	7 W	805 lm	620 lm
PL20EG24BN	4000K	7 W	791 lm	590 lm
PL20EG24BC	3000K	7 W	700 lm	570 lm
PL40EG24BF	5700K	9 W	1035 lm	855 lm
PL40EG24BN	4000K	9 W	1017 lm	836 lm
PL40EG24BC	3000K	9 W	900 lm	827 lm

PLUTONIO

PRO PLL10W / PLL19W / PLL21W

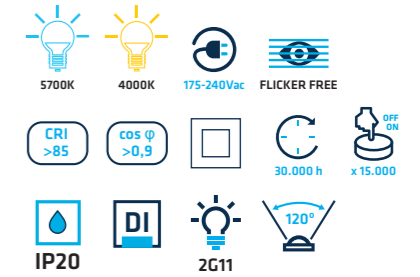

• Material

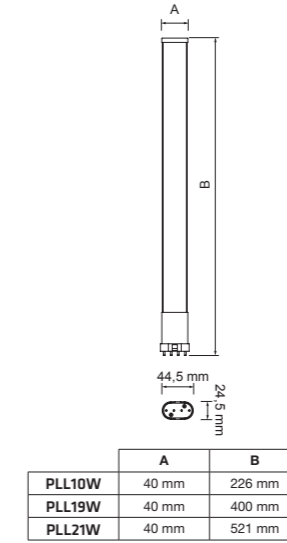

IIIII	CCT	W	N	☀
PLL10WBF	5700K	10 W	1150 lm	900 lm
PLL10WBN	4000K	10 W	1130 lm	850 lm
PLL19WBF	5700K	19 W	2185 lm	1785 lm
PLL19WBN	4000K	19 W	2147 lm	1772 lm
PLL21WBF	5700K	21 W	2415 lm	1890 lm
PLL21WBN	4000K	21 W	2373 lm	1830 lm

PALADIO

PRO PL40E E27

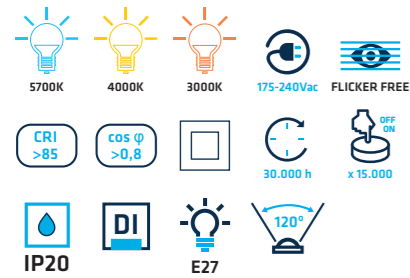

• Material • Opcional

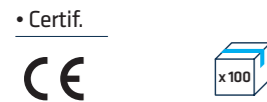

IIIII	CCT	W	N	☀
PL40EE27BF	5700K	9 W	1035 lm	855 lm
PL40EE27BN	4000K	9 W	1017 lm	836 lm
PL40EE27BC	3000K	9 W	900 lm	827 lm

GALIO

PRO G42 / G94

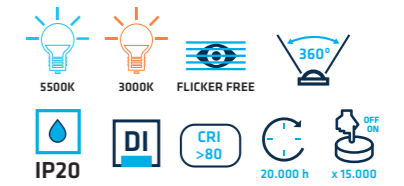

• Material • Certif.

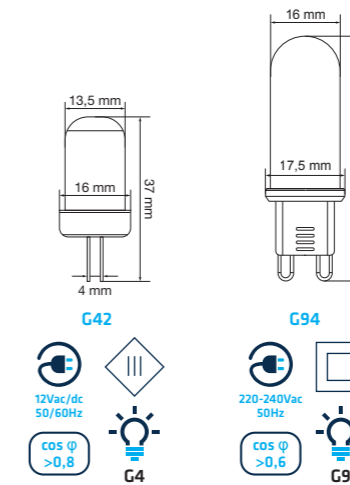

IIIII	CCT	☀	W	N	☀
G4255	5500K	G4	2 W	240 lm	230 lm
G4230	3000K	G4	2 W	240 lm	230 lm
G9455	5500K	G9	4 W	480 lm	470 lm
G9430	3000K	G9	4 W	460 lm	470 lm

PLOMO

ECO PAR20

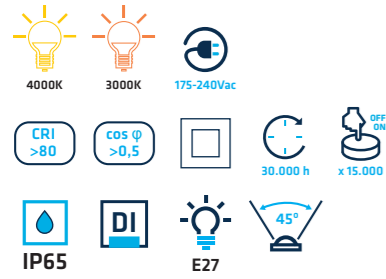

• Material



• Certif.

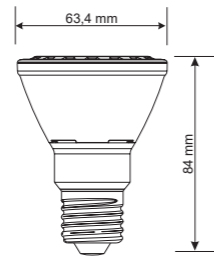

III III	CCT	W	lm	lm
PAR20IP65-5WE27BN	4000K	5 W	575 lm	420 lm
PAR20IP65-5WE27BC	3000K	5 W	565 lm	390 lm

PLOMO

ECO PAR38 VERDE

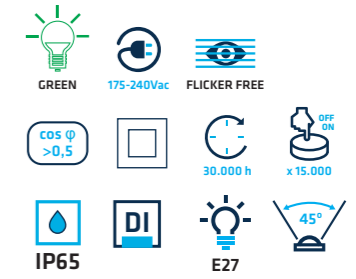

• Material



• Certif.

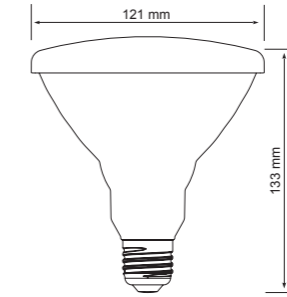

III III	CCT	W
PAR38658WVE	525-530 nm	8 W

PLOMO

ECO PAR30 / PAR38

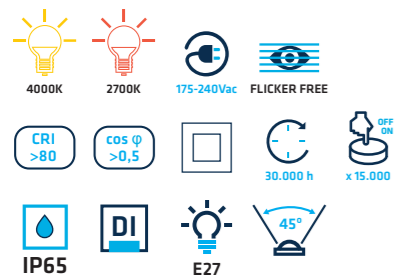

• Material



• Certif.

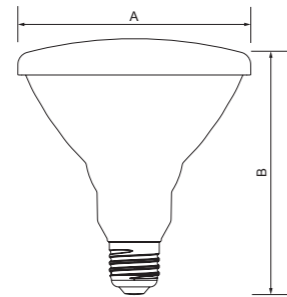

	A	B
PAR30	96 mm	95 mm
PAR38	121 mm	133 mm



III III	CCT	W	lm	lm
PAR306510WE27BN	4000K	10 W	1200 lm	910 lm
PAR306510WE27BC	2700K	10 W	1150 lm	890 lm
PAR386518WE27BN	4000K	18 W	2160 lm	1870 lm
PAR386518WE27BC	2700K	18 W	2070 lm	1850 lm

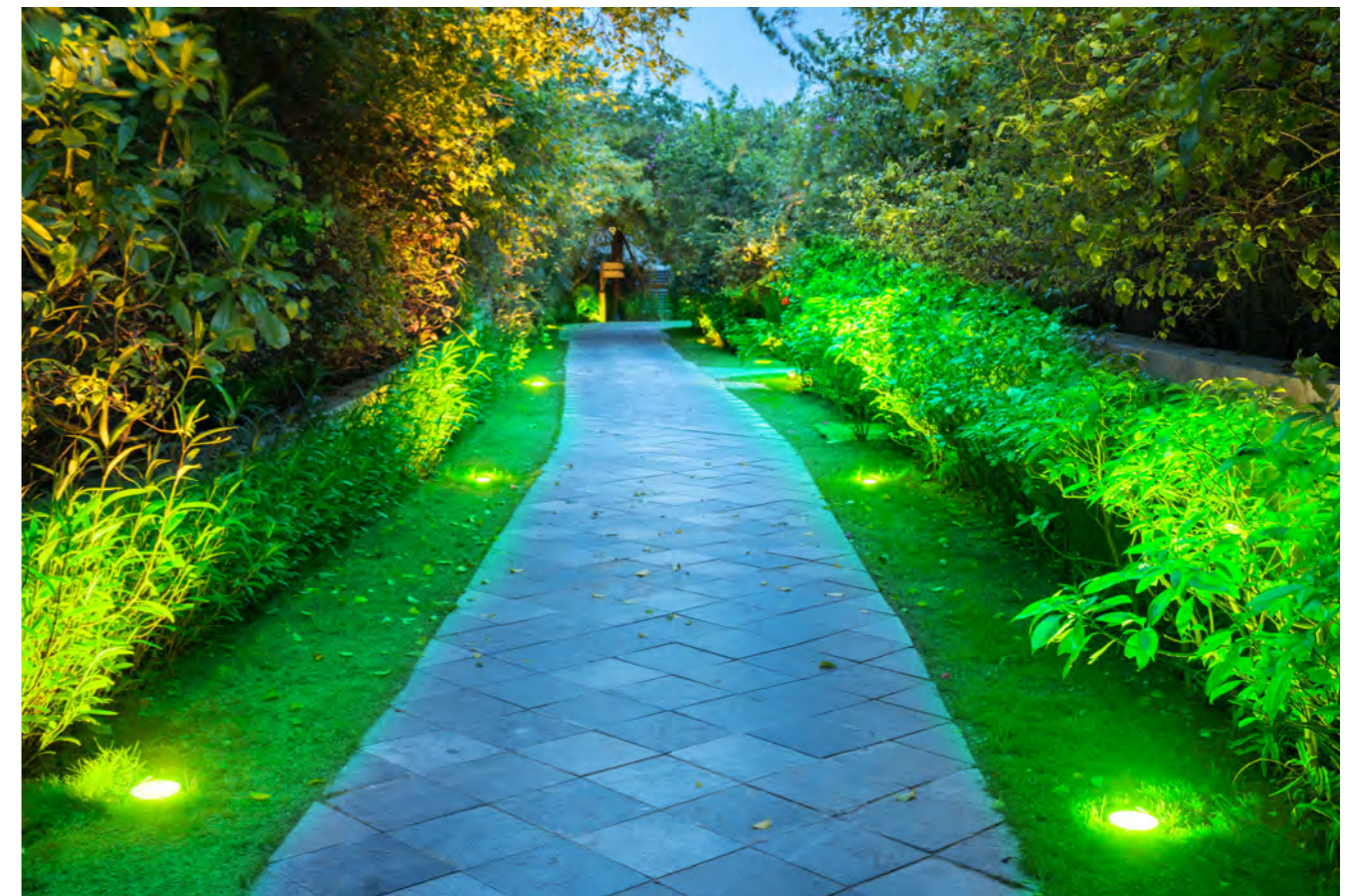

PLATINO



EMPOTRAR / ENCASTRAR

SUPERFICIE / SUPERFÍCIE



PAR56BF

PAR56-SBF



PAR56RGB

PAR56-SRGB



PAR56RCRGB
+
CTRPAR56RC

PAR56-SRCRGB
+
CTRPAR56RC

Material



W

20 W

18 W



60°

120°

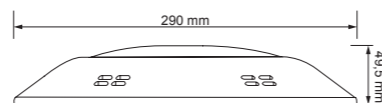
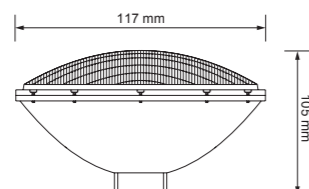

PLATINO

PRO PAR56 / PAR56-S



• Certif.



ESQUEMAS DE CONEXIÓN / ESQUEMAS DE LIGAÇÃO



PAR56BF / PAR56-SBF

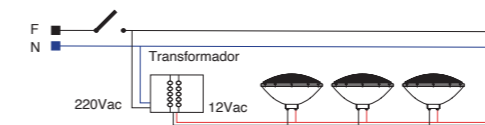

PAR56RGB / PAR56-SRGB

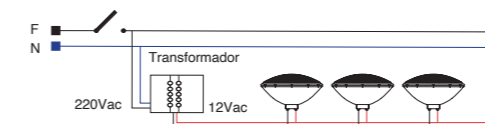

*Este modelo no funciona mediante radiofrecuencia, por lo que no incluye mando. *Este modelo não funciona por radiofrequência e, por isso, não inclui comando.

El cambio de color o escena se realiza mediante breves encendidos y apagados del interruptor. Incluye memoria. A mudança de cor ou cenário é feita mediante interruptor por breves momentos ligado ou desligado. Inclui memória.



PAR56RCRGB / PAR56-SRCRGB

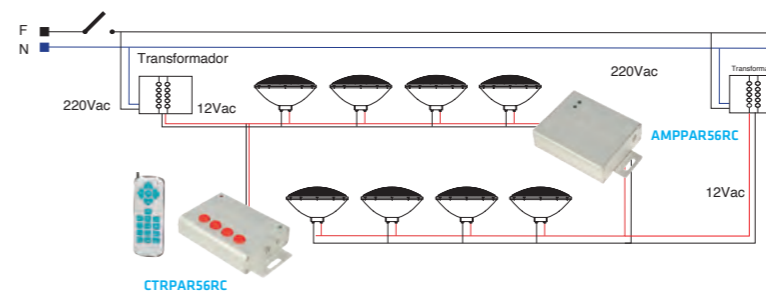

CONTROLLER CTRPAR56RC

Ambas luminarias funcionan con un controlador externo CTRPAR56RC (no incluido), el cual incorpora memoria de estado.

Ambas luminárias funcionam com um controlador externo (não incluido), que incorpora a memória.



AMPLIFIER AMPPAR56RC

A partir de 7 lámparas o 50 m es necesario utilizar amplificador AMPPAR56RC.

A partir de 7 lâmpadas ou mais de 50 m é necessário utilizar amplificador AMPPAR56RC.

Tubos

Tubos



PRO **TIUB PLUS**
T832

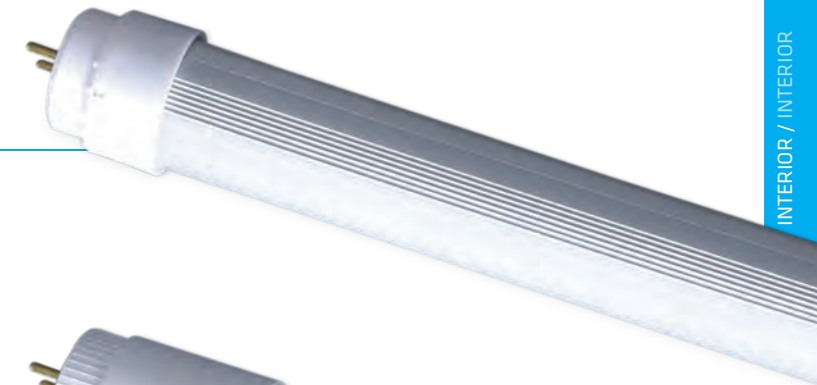

PRO **TIUB**
T8GP



ECO **TIUB GLASS**
T8EG



PRO **TIUB MEAT**
T8FM

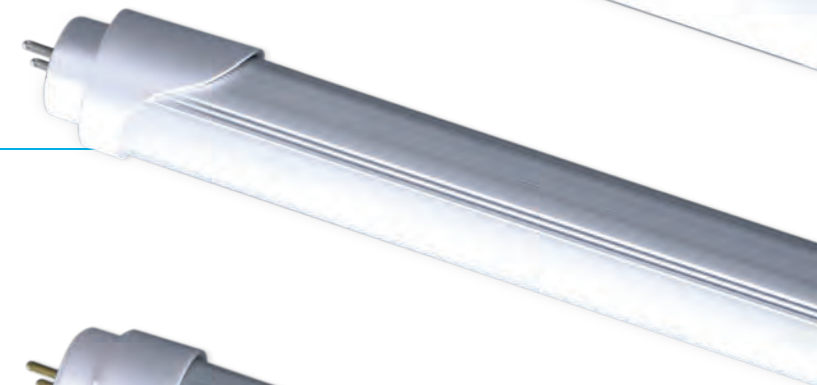

PRO **TIUB FRUIT**
T832

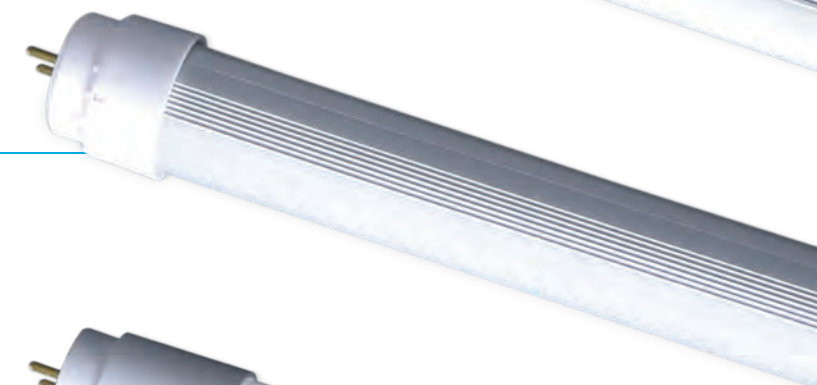

PRO **TIUB 24V**
T824V



TIUB PLUS

PRO T832

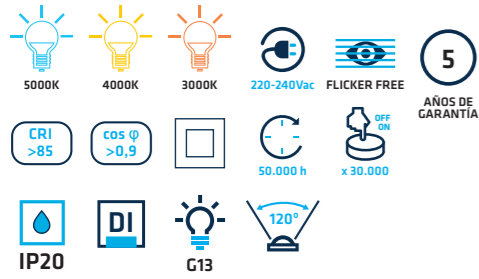

• Material



• Opcional



Ref. KET85

• Certif.



CONECTOR GIRATORIO / CONEXIÓN A UN LADO

LIGADOR GIRATÓRIO / LIGAÇÃO A UM LADO



GARANTÍA 5 AÑOS
GARANTIA 5 ANOS

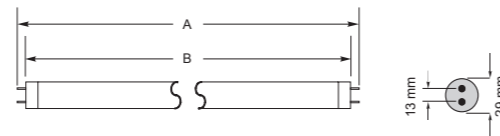

	A	B
T83260UL	605 mm	592 mm
T83290UL	908 mm	894 mm
T832120UL	1216 mm	1200 mm
T832150UL	1515 mm	1500 mm
T832180UL	1782 mm	1768 mm

IIII	CCT	—	W	⌈	⌋
T83260ULBF54	5000K	592 mm	9 W	1125 lm	991 lm
T83260ULBN54	4000K	592 mm	9 W	1107 lm	983 lm
T83260ULBC54	3000K	592 mm	9 W	1080 lm	964 lm
T83290ULBF84	5000K	894 mm	15 W	1875 lm	1600 lm
T83290ULBN84	4000K	894 mm	15 W	1845 lm	1570 lm
T832120ULBF108	5000K	1200 mm	18 W	2250 lm	1940 lm
T832120ULBN108	4000K	1200 mm	18 W	2214 lm	1925 lm
T832120ULBC108	3000K	1200 mm	18 W	2160 lm	1830 lm
T832150ULBF135	5000K	1500 mm	25 W	3125 lm	2825 lm
T832150ULBN135	4000K	1500 mm	25 W	3075 lm	2755 lm
T832150ULBC135	3000K	1500 mm	25 W	3000 lm	2720 lm
T832180ULBF156	5000K	1768 mm	30 W	3750 lm	3125 lm
T832180ULBN156	4000K	1768 mm	30 W	3690 lm	3060 lm

TIUB

PRO T8GP

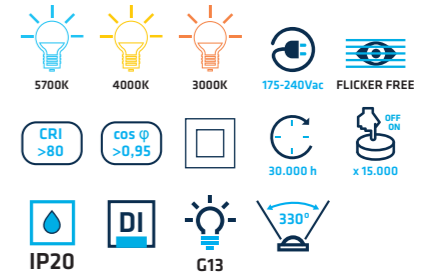

• Material



• Opcional



Ref. KET85

• Certif.



CONEXIÓN A UN LADO

LIGAÇÃO A UM LADO



CRISTAL + PC
VIDRO + PC

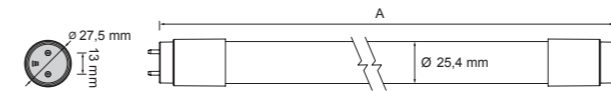

	A
T8GP60	590 mm
T8GP90	895 mm
T8GP120	1200 mm
T8GP150	1500 mm

IIII	CCT	—	W	⌈	⌋
T8GP60BF	5700K	590 mm	9 W	1215 lm	1008 lm
T8GP60BN	4000K	590 mm	9 W	1197 lm	999 lm
T8GP60BC	3000K	590 mm	9 W	1170 lm	990 lm
T8GP90BF	5700K	895 mm	15 W	2025 lm	1680 lm
T8GP90BN	4000K	895 mm	15 W	1995 lm	1665 lm
T8GP90BC	3000K	895 mm	15 W	1950 lm	1650 lm
T8GP120BF	5700K	1200 mm	18 W	2430 lm	2016 lm
T8GP120BN	4000K	1200 mm	18 W	2394 lm	1998 lm
T8GP120BC	3000K	1200 mm	18 W	2340 lm	1980 lm
T8GP150BF	5700K	1500 mm	22 W	2970 lm	2464 lm
T8GP150BN	4000K	1500 mm	22 W	2926 lm	2442 lm
T8GP150BC	3000K	1500 mm	22 W	2860 lm	2420 lm

TIUB GLASS

Eco T8EG

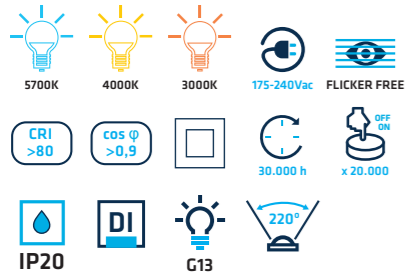

• Material



• Opcional



• Certif.



CONEXIÓN A UN LADO
LIGAÇÃO A UM LADO



	A
T8EG60	588 mm
T8EG90	894 mm
T8EG120	1198 mm
T8EG150	1498 mm

IIII	CCT	IIII	W	N	IIII
T8EG60BF	5700K	588 mm	9 W	1215 lm	1035 lm
T8EG60BN	4000K	588 mm	9 W	1197 lm	1026 lm
T8EG60BC	3000K	588 mm	9 W	1170 lm	990 lm
T8EG90BF	5700K	894 mm	15 W	2025 lm	1725 lm
T8EG90BN	4000K	894 mm	15 W	1995 lm	1710 lm
T8EG90BC	3000K	894 mm	15 W	1950 lm	1650 lm
T8EG120BF	5700K	1198 mm	18 W	2430 lm	2070 lm
T8EG120BN	4000K	1198 mm	18 W	2394 lm	2052 lm
T8EG120BC	3000K	1198 mm	18 W	2340 lm	1980 lm
T8EG150BF	5700K	1498 mm	22 W	2970 lm	2530 lm
T8EG150BN	4000K	1498 mm	22 W	2926 lm	2508 lm
T8EG150BC	3000K	1498 mm	22 W	2860 lm	2420 lm

ESQUEMAS DE CONEXIÓN ESQUEMAS DE LIGAÇÃO

TUBO FLUORESCENTE
CON BALASTO FERROMAGNÉTICO Y CEBADOR.
LÂMPADA FLUORESCENTE
COM BALASTRO FERROMAGNÉTICO E ARRANCADOR.

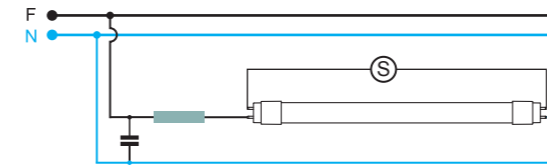

TUBO LED

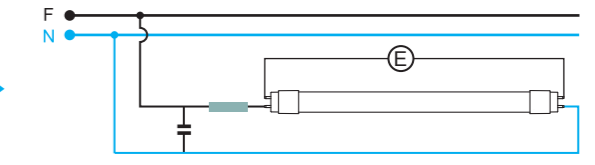

Sustituir el cebador convencional por el cebador especial, suministrado con el tubo LED.
Substituir o arrancador convencional pelo arrancador especial, fornecido com o tubo LED.

TUBO FLUORESCENTE
CON BALASTO ELECTRÓNICO.
LÂMPADA FLUORESCENTE
COM BALASTRO ELETRÔNICO.

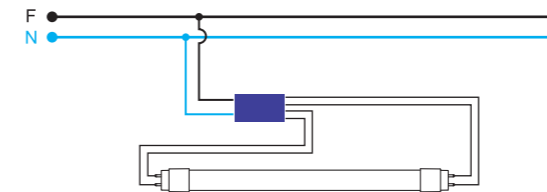

TUBO LED

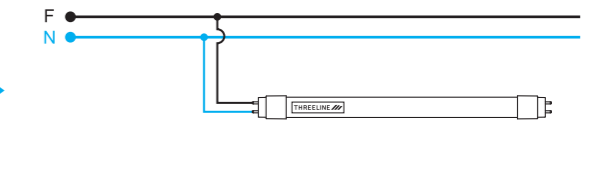

Eliminar equipo e instalar el tubo directamente a fase y neutro en el mismo lado, donde se encuentra la etiqueta.
Remover o equipamento e colocar o tubo diretamente a fase e neutro do mesmo lado, onde está a etiqueta.

ESQUEMA CONEXIÓN PARA TUBOS DE 24V.
ESQUEMA DE LIGAÇÃO PARA TUBOS DE 24V.

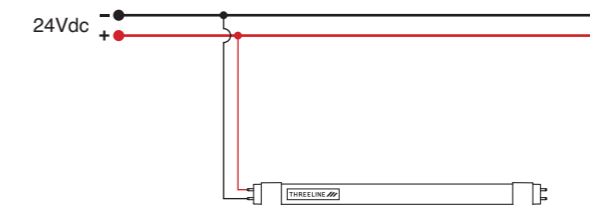

Alimentar a 24Vdc por el lado de la etiqueta.
Alimentar a 24Vdc pelo lado da etiqueta.

- Ⓢ Cebador Convencional / Arrancador Convencional
- ⓔ Cebador Especial LED / Arrancador Especial LED
- Balastro Ferromagnético / Balastro Ferromagnético
- Balastro Eléctrico / Balastro Eléctrico

TIUB MEAT

PRO T8FM

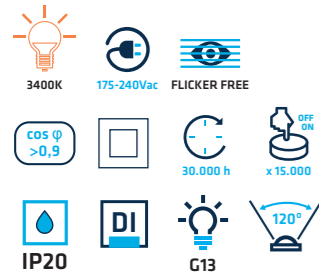

• Material



• Certif.



CONEXIÓN A UN LADO
LIGAÇÃO A UM LADO

	A	B
T8FM60	600 mm	592 mm
T8FM90	905 mm	894 mm
T8FM120	1215 mm	1200 mm
T8FM150	1510 mm	1495 mm

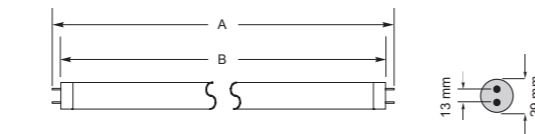

IIIIII	CCT	≡	W	☀	☀
T8FM60	● 3400K	592 mm	9 W	926 lm	850 lm
T8FM90	● 3400K	894 mm	14 W	1428 lm	1300 lm
T8FM120	● 3400K	1200 mm	17 W	1734 lm	1600 lm
T8FM150	● 3400K	1495 mm	21 W	2142 lm	1990 lm



TIUB FRUIT

PRO T832

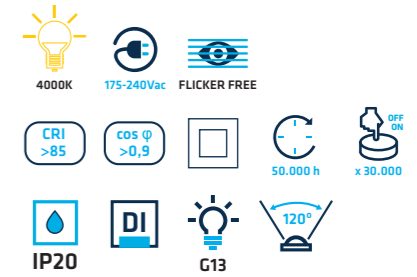

• Material



• Certif.



CONECTOR GIRATORIO / CONEXIÓN A UN LADO
LIGADOR GIRATÓRIO / LIGAÇÃO A UM LADO

	A	B
T83260UL	605 mm	592 mm
T83290UL	908 mm	894 mm
T832120UL	1216 mm	1200 mm
T832150UL	1515 mm	1500 mm

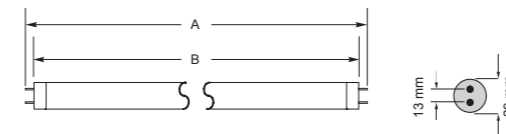

IIIIII	CCT	≡	W	☀	☀
T83260ULBN54	● 4000K	592 mm	9 W	1107 lm	983 lm
T83290ULBN84	● 4000K	894 mm	15 W	1845 lm	1570 lm
T832120ULBN108	● 4000K	1200 mm	18 W	2214 lm	1925 lm
T832150ULBN135	● 4000K	1500 mm	25 W	3075 lm	2755 lm



TIUB 24V

PRO T824V

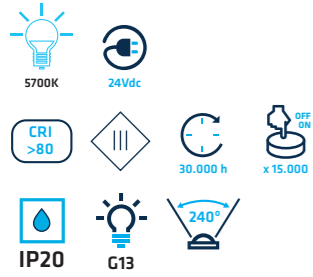

• Material



• Certif.



CONEXIÓN A UN LADO
LIGAÇÃO A UM LADO



	A	B
T824V60	600 mm	590 mm
T824V120	1216 mm	1200 mm
T824V150	1515 mm	1500 mm

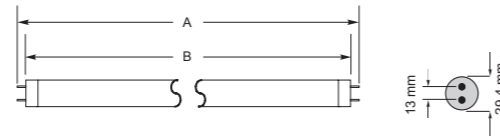

IIIIII	CCT	≡	W	☀	☀
T824V60BF	● 5700K	590 mm	9 W	1125 lm	960 lm
T824V120BF	● 5700K	1200 mm	18 W	2250 lm	1890 lm
T824V150BF	● 5700K	1500 mm	22 W	2750 lm	2266 lm

TIVE

PRO T5R

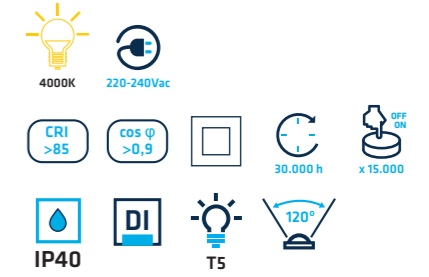

• Material



• Certif.



CON INTERRUPTOR
COM INTERRUPTOR
Cos φ > 0.9

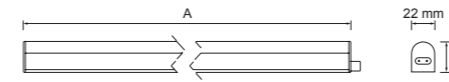

	A
T5R30	313 mm
T5R60	573 mm
T5R90	873 mm
T5R120	1173 mm
T5R150	1473 mm

IIIIII	CCT	≡	W	☀	☀
T5R30BN	● 4000K	313 mm	4 W	480 lm	370 lm
T5R60BN	● 4000K	573 mm	8 W	960 lm	750 lm
T5R90BN	● 4000K	873 mm	10 W	1200 lm	940 lm
T5R120BN	● 4000K	1173 mm	14 W	1680 lm	1320 lm
T5R150BN	● 4000K	1473 mm	18 W	2160 lm	1700 lm

Pantallas Estancas Armaduras Estanques



Proyectores Projetores

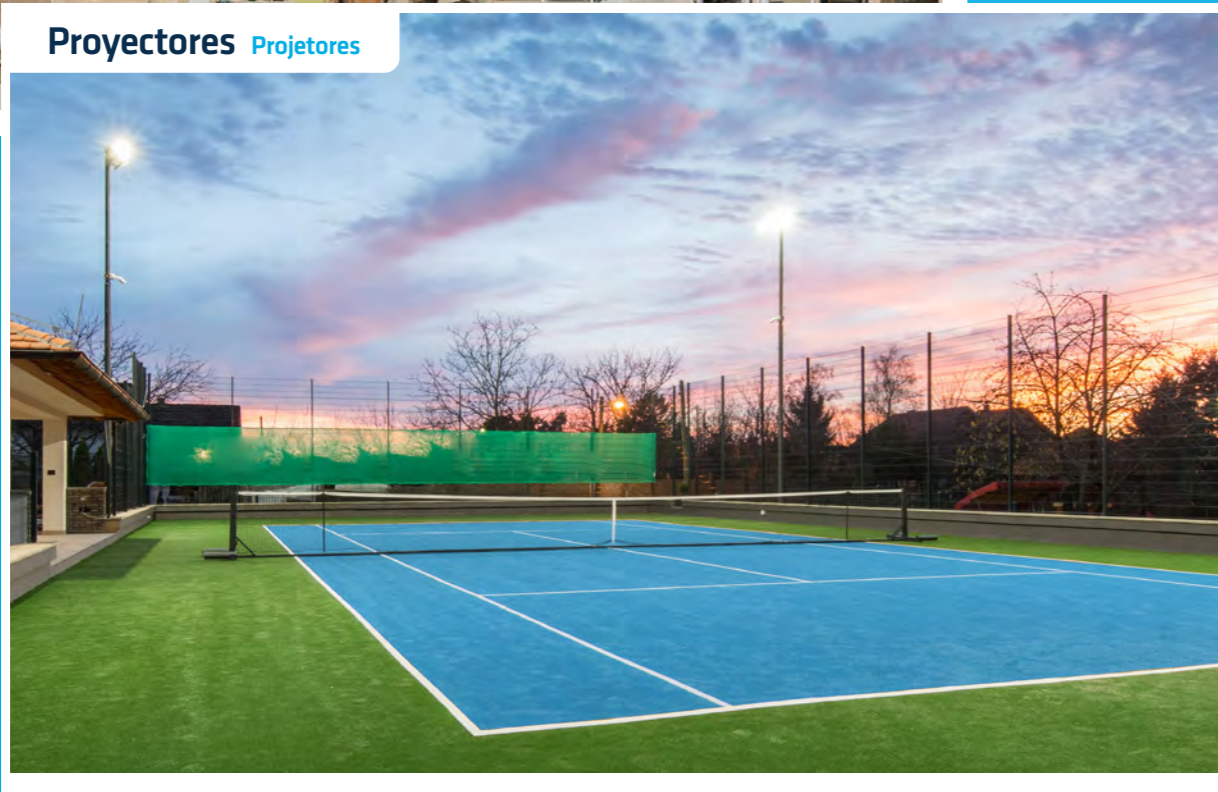

Campanas Campânulas



Gasolineras Gasolineiras



Pantallas Estancas Armaduras Estanques



PANTALLAS ESTANCAS
ARMADURAS ESTANQUES

CAMPANAS
CAMPÂNULAS

PROYECTORES
PROJETORES

GASOLINERAS
GASOLINEIRAS

PRO **KATIA**

Pantalla estanca para tubo LED
Armadura estanque para tubo LED

IP65 IK10



PRO **KLAUS**

Pantalla estanca con LED integrado
Armadura estanque com LED integrado

5 AÑOS DE GARANTÍA
IP65 IK08
130lm/W reales/reais
KE



ECO **TAKAT** NEW

Pantalla estanca ON/OFF con LED integrado
Armadura estanque ON/OFF com LED integrado

130lm/W reales/reais
5 AÑOS DE GARANTÍA
IP65 IK08

INDUSTRIAL / INDUSTRIAL

KATIA

Pantalla estanca para tubo LED

Armadura estanque para tubo LED

**CABLEADO ESPECIAL
Y EXCLUSIVO DE THREELINE**

**CABOS ESPECIAIS
E EXCLUSIVOS DE THREELINE**

Difusor de policarbonato
Difusor em policarbonato

Cuerpo de policarbonato
Corpo em policarbonato

**Clip de fijación al techo
de acero inoxidable**

**Clip de fixação de teto
em aço inoxidável**

Clips de acero inoxidable
Clips de aço inoxidável

KATIA

PRO PE118 / PE136 / PE158

IP65 IK10 RAL7047

• Material

PC DIFUSOR PC CUERPO

• Opcional

PE136 KE Ref. PE136KE PE158 KE Ref. PE158KE

• Certif.

CE



IIIIII	DESCRIPCIÓN
PE118	Pantalla estanca para 1 tubo de 600 mm. Armadura estanque para 1 tubo de 600 mm.
PE136	Pantalla estanca para 1 tubo de 1200 mm. Armadura estanque para 1 tubo de 1200 mm.
PE158	Pantalla estanca para 1 tubo de 1500 mm. Armadura estanque para 1 tubo de 1500 mm.

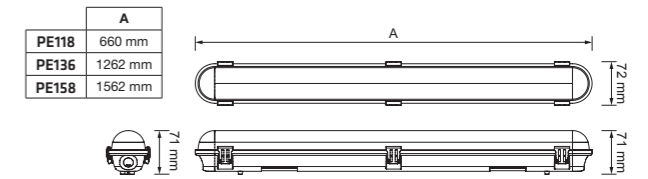

KATIA

PRO PE218 / PE236 / PE258

IP65 IK10 RAL7047

• Material

PC DIFUSOR PC CUERPO

• Opcional

PE236 KE Ref. PE236KE PE258 KE Ref. PE258KE

• Certif.

CE



IIIIII	DESCRIPCIÓN
PE218	Pantalla estanca para 2 tubos de 600 mm. Armadura estanque para 2 tubos de 600 mm.
PE236	Pantalla estanca para 2 tubos de 1200 mm. Armadura estanque para 2 tubos de 1200 mm.
PE258	Pantalla estanca para 2 tubos de 1500 mm. Armadura estanque para 2 tubos de 1500 mm.

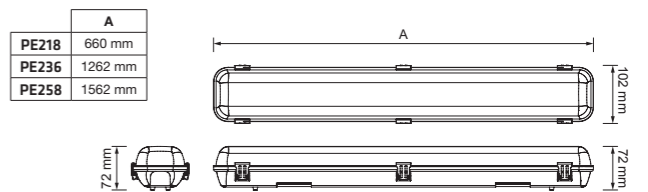

KLAUS

Pantalla estanca con difusor semitransparente y alta eficiencia

Armadura estanque com difusor semitransparente e elevada eficiência



Difusor de policarbonato semitransparente
Difusor policarbonato semitransparente



130lm/W
reales/reais

Cuerpo de policarbonato
Corpo em policarbonato



Abrazadera de acero inoxidable
Instalación en superficie
Abraçadeira em aço inoxidável
Instalação à superfície

Clips de acero inoxidable
Clip em aço inoxidável

Módulo LED integrado de 120 lm/W reales.
Posibilidad de personalizar la eficiencia hasta 200 lm/W reales.
Módulo LED integrado 120 lm/W reais.
Possibilidade de personalizar a eficiência até 200lm/W reais.



KLAUS

PRO KLS



• Material



• Opc. de Reg.

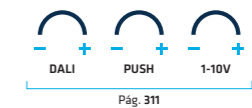

• Opcional



• Certif.



	A
KLS60-20	600 mm
KLS120-40	1200 mm
KLS150-55	1500 mm

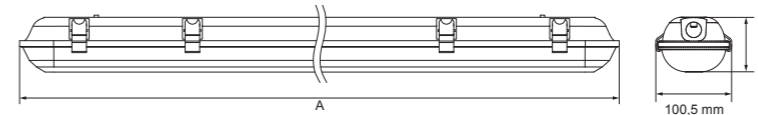

	III	CCT	≡	W	☀	☀
NEW	KLS60-10BF	● 5700K	600 mm	10 W	1420 lm	1223 lm
NEW	KLS60-10BN	● 4000K	600 mm	10 W	1420 lm	1223 lm
	KLS60-20BF	● 5700K	600 mm	20 W	2840 lm	2446 lm
	KLS60-20BN	● 4000K	600 mm	20 W	2840 lm	2446 lm
NEW	KLS120-20BF	● 5700K	1200 mm	20 W	2840 lm	2446 lm
NEW	KLS120-20BN	● 4000K	1200 mm	20 W	2840 lm	2446 lm
	KLS120-40BF	● 5700K	1200 mm	40 W	5680 lm	4885 lm
	KLS120-40BN	● 4000K	1200 mm	40 W	5680 lm	4885 lm
NEW	KLS150-25BF	● 5700K	1500 mm	25 W	3550 lm	3037 lm
NEW	KLS150-25BN	● 4000K	1500 mm	25 W	3550 lm	3037 lm
	KLS150-55BF	● 5700K	1500 mm	55 W	7810 lm	6682 lm
	KLS150-55BN	● 4000K	1500 mm	55 W	7810 lm	6682 lm

KLAUS. CARACTERÍSTICAS

Difusor pc semitransparente
Difusor pc semitransparente



Cuerpo de PC
Corpo em PC



Clips de acero inoxidable
Clip em aço inoxidável



Abrazadera de acero inoxidable
Abraçadeira em aço inoxidável

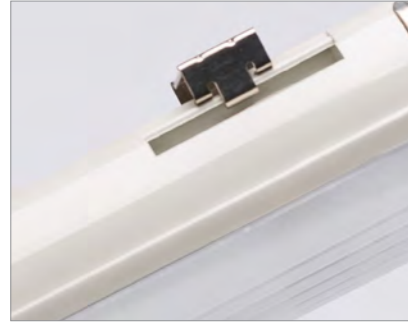

Módulo LED integrado 140 lm/W
Módulo LED integrado 140 lm/W



Conector estanco PG13.5
Ligador estanque PG13.5



Driver TRIDONIC
Driver TRIDONIC



Regleta de conexión rápida
Ligador rápido

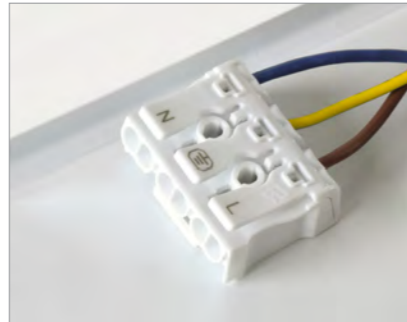

Fijación suspensión
Fixação em suspensão



KLAUS. OPCIONES / OPÇÕES

ACCESORIO FIJACIÓN A PARED 40° / ACESSÓRIO DE FIXAÇÃO NA PAREDE 40°

AESKLS40

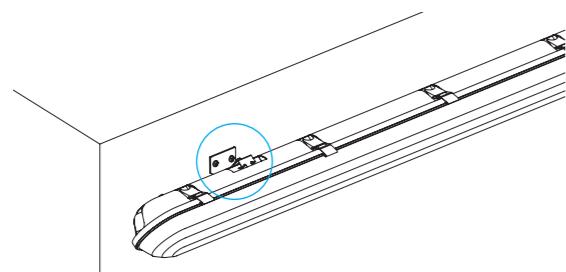

KLAUS. OPCIONES / OPÇÕES

KE KIT DE EMERGENCIA
KIT EMERGÊNCIA



SENSOR MOV. INTERNO
SENSOR MOV. INTERNO



SENSOR MOV. EXTERNO
SENSOR MOV. EXTERNO



	W	KE		
● KLS60-10BF	10 W	KLS60-10KEBF	KLS60-10SMBF	KLS60-10SCBF
● KLS60-10BN	10 W	KLS60-10KEBN	KLS60-10SMBN	KLS60-10SCBN
● KLS60-20BF	20 W	KLS60-20KEBF	KLS60-20SMBF	KLS60-20SCBF
● KLS60-20BN	20 W	KLS60-20KEBN	KLS60-20SMBN	KLS60-20SCBN
● KLS120-20BF	20 W	KLS120-20KEBF	KLS120-20SMBF	KLS120-20SCBF
● KLS120-20BN	20 W	KLS120-20KEBN	KLS120-20SMBN	KLS120-20SCBN
● KLS120-40BF	40 W	KLS120-40KEBF	KLS120-40SMBF	KLS120-40SCBF
● KLS120-40BN	40 W	KLS120-40KEBN	KLS120-40SMBN	KLS120-40SCBN
● KLS150-25BF	25 W	KLS150-25KEBF	KLS150-25SMBF	KLS150-25SCBF
● KLS150-25BN	25 W	KLS150-25KEBN	KLS150-25SMBN	KLS150-25SCBN
● KLS150-55BF	55 W	KLS150-55KEBF	KLS150-55SMBF	KLS150-55SCBF
● KLS150-55BN	55 W	KLS150-55KEBN	KLS150-55SMBN	KLS150-55SCBN



MSC65V2

Mando para cambiar la configuración.
Comando para alterar configuração.

OPCIONES DE CONEXIONADO / OPÇÕES DE LIGAÇÃO

AL Conexión a ambos lados
Ligaço a ambos lados



PG13

CR1 Conexión rápida a un lado
Ligaço rápida a un lado



Conector rápido
Ligador rápido

CR2 Conexión rápida a ambos lados
Ligaço rápida a ambos lados



Conector rápido
Ligador rápido

	CCT		W			
● KLS60-10BF	5700K	600 mm	10 W	KLS60-10ALBF	KLS60-10CR1BF	KLS60-10CR2BF
● KLS60-10BN	4000K	600 mm	10 W	KLS60-10ALBN	KLS60-10CR1BN	KLS60-10CR2BN
● KLS60-20BF	5700K	600 mm	20 W	KLS60-20ALBF	KLS60-20CR1BF	KLS60-20CR2BF
● KLS60-20BN	4000K	600 mm	20 W	KLS60-20ALBN	KLS60-20CR1BN	KLS60-20CR2BN
● KLS120-20BF	5700K	1200 mm	20 W	KLS120-20ALBF	KLS120-20CR1BF	KLS120-20CR2BF
● KLS120-20BN	4000K	1200 mm	20 W	KLS120-20ALBN	KLS120-20CR1BN	KLS120-20CR2BN
● KLS120-40BF	5700K	1200 mm	40 W	KLS120-40ALBF	KLS120-40CR1BF	KLS120-40CR2BF
● KLS120-40BN	4000K	1200 mm	40 W	KLS120-40ALBN	KLS120-40CR1BN	KLS120-40CR2BN
● KLS150-25BF	5700K	1500 mm	25 W	KLS150-25ALBF	KLS150-25CR1BF	KLS150-25CR2BF
● KLS150-25BN	4000K	1500 mm	25 W	KLS150-25ALBN	KLS150-25CR1BN	KLS150-25CR2BN
● KLS150-55BF	5700K	1500 mm	55 W	KLS150-55ALBF	KLS150-55CR1BF	KLS150-55CR2BF
● KLS150-55BN	4000K	1500 mm	55 W	KLS150-55ALBN	KLS150-55CR1BN	KLS150-55CR2BN

NEW
TAKAT

Pantalla estanca ON/OFF con difusor semitransparente.
Armadura estanque ON/OFF com difusor semitransparente.

130lm/W
reales/reais

IK08 Difusor de policarbonato semitransparente
Difusor policarbonato semitransparente



Abrazadera de acero inoxidable
Instalación en superficie
Braçadeira em aço inoxidável
Instalação à superfície

IK08 Cuerpo de policarbonato
Corpo em policarbonato

Soporte para montaje en suspensión
Braçadeira para instalação em suspensão



Cableado interno para permitir conexión en línea
Internamente ligado para permitir a instalação linear



Conexión rápida en ambos lados
Ligador rápido nos dois extremos



Módulo led integrado 130 lm/w reales
Módulo led integrado 130 lm/w reais



TAKAT

TKT



• Material



• Certif.



130lm/W reales
130lm/W reais

	A
TKT60-20	600 mm
TKT120-40	1200 mm
TKT150-55	1500 mm

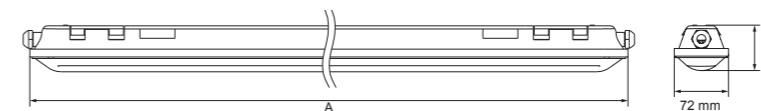

III III	CCT	≡	W	⬆	⬆
TKT60-2060	● 6000K	600 mm	20 W	3000 lm	2600 lm
TKT60-2040	● 4000K	600 mm	20 W	3000 lm	2600 lm
TKT120-4060	● 6000K	1200 mm	40 W	6000 lm	5200 lm
TKT120-4040	● 4000K	1200 mm	40 W	6000 lm	5200 lm
TKT150-5560	● 6000K	1500 mm	55 W	8250 lm	7150 lm
TKT150-5540	● 4000K	1500 mm	55 W	8250 lm	7150 lm

Campañas Campânulas



PANTALLAS ESTANCAS
ARMADURAS ESTANQUES

CAMPANAS
CAMPÂNULAS

PROYECTORES
PROJETORES

GASOLINERAS
GASOLINEIRAS



THREELINE
DISEÑO PROPIO
DESIGN PROPRIO

170lm/W
reales/reais

5
AÑOS DE
GARANTÍA

IP65

FLICKER FREE

PRE-MIUM CLOE

THREELINE
REGULABLE 0-10V
AJUSTÁVEL 0-10V

NEW PRO TELLY

FLICKER FREE

IP65

5
AÑOS DE
GARANTÍA

160lm/W
reales/reais

60°

90°

120°



140lm/W
reales/reais

5
AÑOS DE
GARANTÍA

IP65

FLICKER FREE

ECO ISI NEW

CLOE

PREMIUM CQM



• Certif.



LED de alta luminosidad 7070
(200lm/w)

LED de alta luminosidade 7070
(200lm/w)

Cuerpo de aluminio anodizado
Corpo em alumínio anodizado

Lentes de cristal >99%
de transmisión

Lentes de vidro > 99%
de transmissão

Soporte frontal de aluminio
Suporte frontal de alumínio

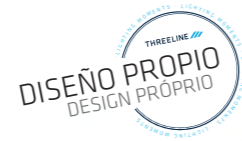

Ángulo de inclinación
regulable

Ângulo de inclinação
regulável

Tornillería de acero
Inoxidable

Parafusos em aço
inoxidável



CONECTOR ESTANCO INCLUIDO
LIGADOR ESTANQUE INCLUIDO

200lm/W

*Otros acabados a consultar / Para outros acabamentos consultar

CLOE

CQM PREMIUM

8.000lm



40W CQM104AG7

16.000lm



80W CQM208AG7

24.000lm



120W CQM312AG7

32.000lm



160W CQM416AG7

40.000lm



200W CQM520AG7

CLOE

PREMIUM CQM104AG7

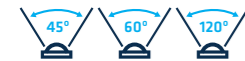
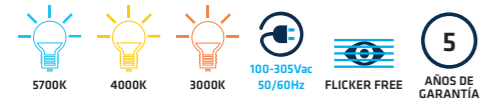

• Material



• Opc. de Reg.



• Certif.



THREELINE
170lm/W reales
170lm/W reais

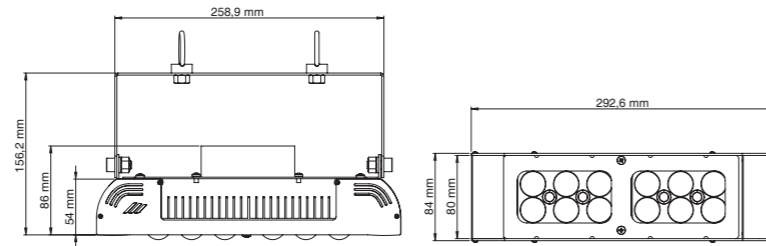

*Genera tu referencia / Gere a sua referência

IIII	CCT	W	Beam	Code	Reg.	Opt.	OPCIONAL
CQM104AG7	● 5700K	57	45°	04	Sin regulación	M0	Kit de Emergencia U
	● 4000K	40	60°	06	0/1-10V	M1	
	● 3000K	30	120°	12	Dali	M2	

W	CCT	Beam	Beam
40 W	● 5700K	8000 lm	6800 lm
	● 4000K	7840 lm	6664 lm
	● 3000K	7600 lm	6460 lm

*Otros acabados a consultar / Para outros acabamentos consultar

CLOE

PREMIUM CQM208AG7

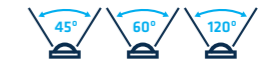

• Material



• Opc. de Reg.



• Certif.



THREELINE
170lm/W reales
170lm/W reais

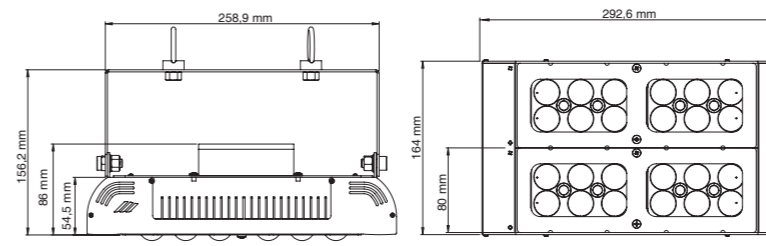

*Genera tu referencia / Gere a sua referência

IIII	CCT	W	Beam	Code	Reg.	Opt.	OPCIONAL
CQM208AG7	● 5700K	57	45°	04	Sin regulación	M0	Kit de Emergencia U
	● 4000K	40	60°	06	0/1-10V	M1	
	● 3000K	30	120°	12	Dali	M2	

W	CCT	Beam	Beam
80 W	● 5700K	16000 lm	13600 lm
	● 4000K	15680 lm	13328 lm
	● 3000K	15200 lm	12920 lm

*Otros acabados a consultar / Para outros acabamentos consultar

CLOE

PREMIUM CQM312AG7

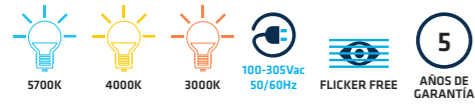

• Material



• Opc. de Reg.



• Certif.



THREELINE
170lm/W reales
170lm/W reais

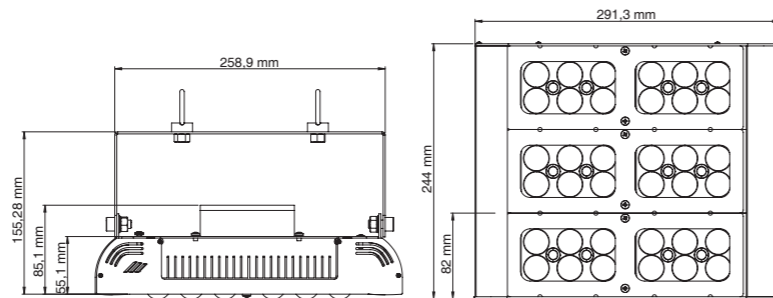

*Genera tu referencia / Gere a sua referência

IIIIII	CCT	W	Beam	Reg.	Control	OPCIONAL
CQM312AG7	● 5700K	57	45°	04	Sin regulación	M0 Kit de Emergencia U
	● 4000K	40	60°	06	0/1-10V	M1
	● 3000K	30	120°	12	Dali	M2

*Otros acabados a consultar / Para outros acabamentos consultar

CLOE

PREMIUM CQM416AG7



• Material



• Opc. de Reg.



• Certif.



THREELINE
170lm/W reales
170lm/W reais

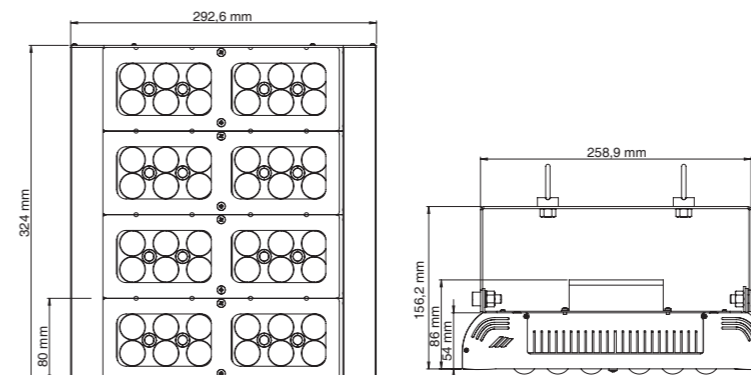

*Genera tu referencia / Gere a sua referência

IIIIII	CCT	W	Beam	Reg.	Control	OPCIONAL
CQM416AG7	● 5700K	57	45°	04	Sin regulación	M0 Kit de Emergencia U
	● 4000K	40	60°	06	0/1-10V	M1
	● 3000K	30	120°	12	Dali	M2

*Otros acabados a consultar / Para outros acabamentos consultar

CLOE

PREMIUM CQM520AG7

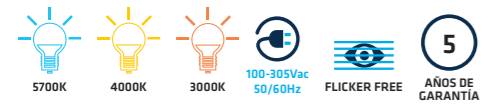

• Material



• Opc. de Reg.



• Certif.



THREELINE
170lm/W reales
170lm/W reales

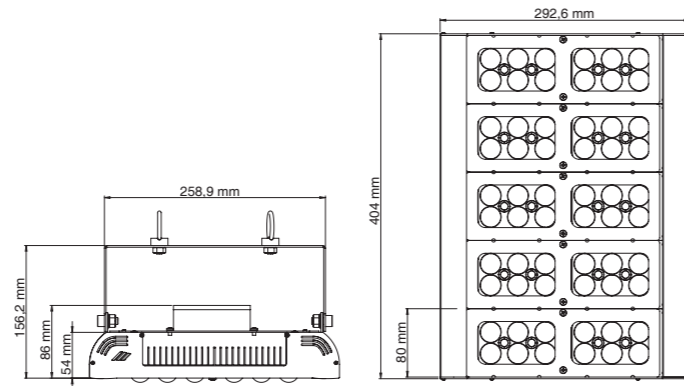

*Genera tu referencia / Gere a sua referência

CQM520AG7	CCT				OPCIONAL	W	CCT	N	L
	●	●	●	●					
● 5700K	57	45°	04	Sin regulación	M0	● 5700K	40000 lm	34000 lm	
● 4000K	40	60°	06	0/1-10V	M1	200 W ● 4000K	39200 lm	33320 lm	
● 3000K	30	120°	12	Dali	M2	● 3000K	38000 lm	32300 lm	

*Otros acabados a consultar / Para outros acabamentos consultar

CLOE. PERSONALIZACIÓN DE LENTES PERSONALIZAÇÃO DE LENTES



INDUSTRIAL / INDUSTRIAL

NEW
TELLY

PRO HBT



Driver regulable 0/1-10V
incluido.
Driver regulável 0/1-10V
incluído.

160lm/W
reales/reais

Cierre estanco para
conexión 0/1-10V incluido.
Entrada estanque de
regulação 0/1-10V incluída.

Anilla plegable.
Argola ajustável.

Diseño compacto.
Design compacto.

Fabricada en aleación
de aluminio ADC12.
Fabricado em liga
de alumínio ADC12.

Lente de policarbonato resistente UV.
IK10 Lentes em policarbonato resistente UV.

LED de alta luminosidad 160 lm/W reales.
LED de alta luminosidade 160 lm/W reais.

Diseño de disipación optimizado.
Design de dissipação optimizado.

IP65

TELLY. ACCESORIOS / ACESSÓRIOS

Accesorio Asa disponible
Acessório de Suporte
disponível.



Reflector de aluminio
para bajo nivel de UGR.
Refletor em alumínio
para baixos níveis de UGR.



SENSORES COMPATIBLES CON LA BASE ZHAGA / SENSORES COMPATÍVEIS COM BASE ZHAGA



PIR Sensor PIR



Bluetooth®

Sensor inalámbrico
Sensor sem fios.



Usar con gateway Bluetooth para acceso remoto.
Use Bluetooth gateway para aceder remotamente.



Base Zhaga.

Opciones de control inteligente.
Opções de controlo inteligente.

TELLY

PRO HBT100 / HBT150

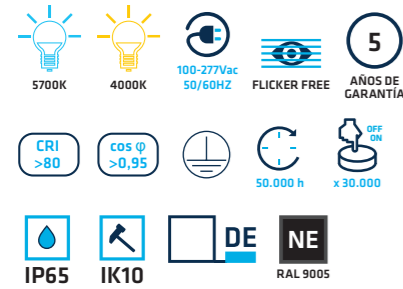

• Material



• Incluido



• Opc. de Reg.



• Opcional



REGULABLE 0-10V
AJUSTÁVEL 0-10V
160lm/W reales
160lm/W reais

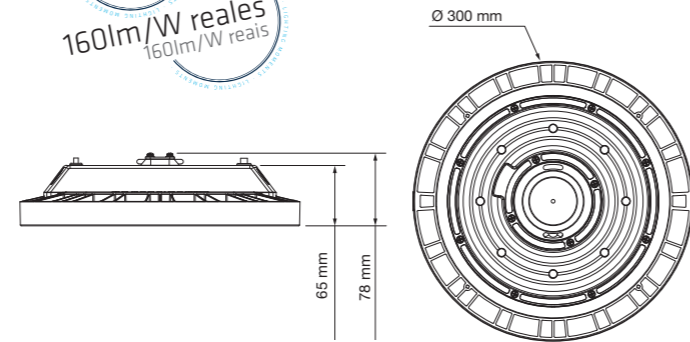

OPCIONES	CCT	W	18000 lm	16000 lm	60°
HBT1005760 *	5700K	100 W	18000 lm	16000 lm	60°
HBT1004060 *	4000K	100 W	18000 lm	16000 lm	60°
HBT1005790 *	5700K	100 W	18000 lm	16000 lm	90°
HBT1004090 *	4000K	100 W	18000 lm	16000 lm	90°
HBT10057120 *	5700K	100 W	18000 lm	16000 lm	120°
HBT10040120 *	4000K	100 W	18000 lm	16000 lm	120°
HBT1505760 *	5700K	150 W	27000 lm	24000 lm	60°
HBT1504060 *	4000K	150 W	27000 lm	24000 lm	60°
HBT1505790 *	5700K	150 W	27000 lm	24000 lm	90°
HBT1504090 *	4000K	150 W	27000 lm	24000 lm	90°
HBT15057120 *	5700K	150 W	27000 lm	24000 lm	120°
HBT15040120 *	4000K	150 W	27000 lm	24000 lm	120°

* Opc. de Reg. D2 DALI
* Opcional S3 Sensor de movimiento y luminosidad, AV Rejilla antivandálica, E Kit de emergencia

TELLY

PRO HBT200

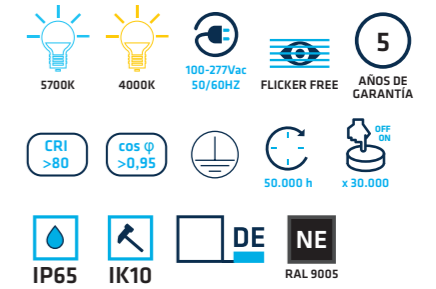

• Material



• Incluido



• Opc. de Reg.



• Opcional

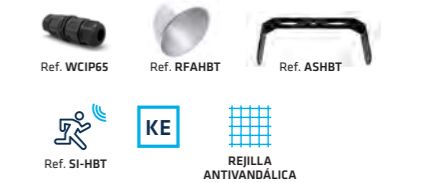

REGULABLE 0-10V
AJUSTÁVEL 0-10V
160lm/W reales
160lm/W reais

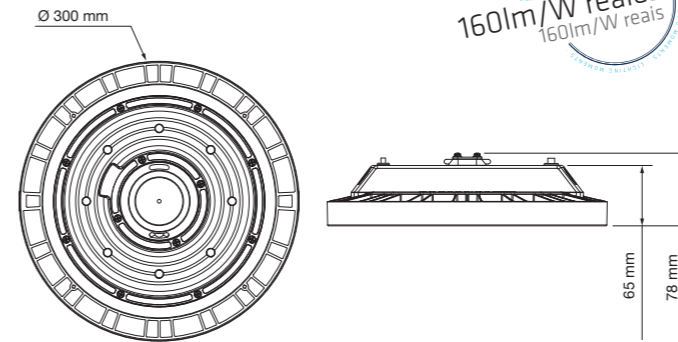

OPCIONES	CCT	W	36000 lm	32000 lm	60°
HBT2005760 *	5700K	200 W	36000 lm	32000 lm	60°
HBT2004060 *	4000K	200 W	36000 lm	32000 lm	60°
HBT2005790 *	5700K	200 W	36000 lm	32000 lm	90°
HBT2004090 *	4000K	200 W	36000 lm	32000 lm	90°
HBT20057120 *	5700K	200 W	36000 lm	32000 lm	120°
HBT20040120 *	4000K	200 W	36000 lm	32000 lm	120°

* Opc. de Reg. D2 DALI
* Opcional S3 Sensor de movimiento y luminosidad, AV Rejilla antivandálica, E Kit de emergencia

NEW
ISI

ECO HBI



100 W 150 W 200 W

Diseño compacto.
Design compacto.

Anilla plegable.
Argola ajustável.



140lm/W reales/reais

Molde de una sola pieza.
Molde em peça única.

LED de alta luminosidad
140 lm/W reales.
LED de alta luminosidade
140 lm/W reais.

Lente de policarbonato resistente UV.
Lentes em policarbonato resistente UV. IK10

Fabricada en aleación de aluminio ADC12.
Fabricado em liga de alumínio ADC12.

Disipación del calor optimizada.
Dissipação de calor optimizada.

IP65

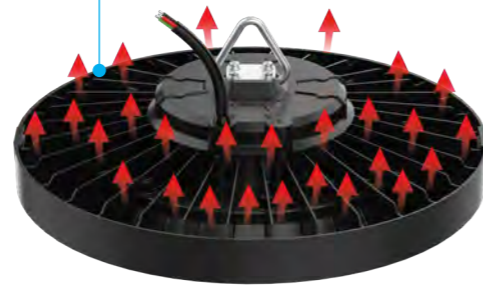

ISI. ACCESORIOS / ACESSÓRIOS

Accesorio Asa disponible
Acessório de Suporte disponível.



Reflector de aluminio
para bajo nivel de UGR.
Refletor em alumínio
para baixos níveis de UGR.



ISI

ECO HBI100 / HBI150 / HBI200



Material



Opcional



Certif.



THREELINE
140lm/W reales
140lm/W reais

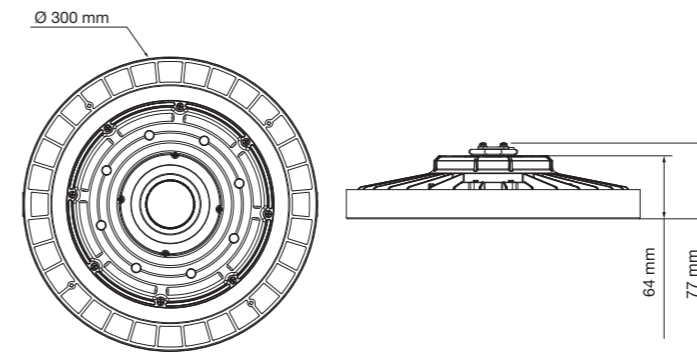

III	OPCIONES		CCT	W	☀	☀	◡
HBI10057120	*	B	● 5700K	100 W	16000 lm	14000 lm	120°
HBI10040120	*	B	● 4000K	100 W	16000 lm	14000 lm	120°
HBI15057120	*	B	● 5700K	150 W	24000 lm	21000 lm	120°
HBI15040120	*	B	● 4000K	150 W	24000 lm	21000 lm	120°
HBI20057120	*	B	● 5700K	200 W	32000 lm	28000 lm	120°
HBI20040120	*	B	● 4000K	200 W	32000 lm	28000 lm	120°

* Opcional
AV Rejilla antivandálica

Proyectores Projetores



PANTALLAS ESTANCAS
ARMADURAS ESTANQUES

CAMPANAS
CAMPÂNULAS

PROYECTORES
PROJETORES

GASOLINERAS
GASOLINEIRAS



170lm/W
reales/reais

PREMIUM
PALAU
5
AÑOS DE GARANTÍA
IP65



PREMIUM
PANAMA

IP65

5
AÑOS DE GARANTÍA

170lm/W
reales/reais



PREMIUM
OLYMPIC II NEW

150lm/W
reales/reais

5
AÑOS DE GARANTÍA

IP66



NEW
PRO
LYON

IP66

5
AÑOS DE GARANTÍA

140lm/W
reales/reais



ECO
IPROY

BL
RAL 9016

NE
RAL 7015

IP65

100lm/W
reales/reais

NEW
ECO
IVO

IP65

100lm/W
reales/reais



PALAU

PREMIUM QMP



THREELINE
DISEÑO PROPIO
DESIGN PRÓPRIO

200lm/W

Soporte frontal de aluminio
Suporte frontal de alumínio

• Certif.



Junta de silicona
Junta de silicone

LED de alta luminosidad 7070
(200lm/w)
LED de alta luminosidade 7070
(200lm/w)

Lentes de cristal
>99% De transmisión
Lentes de vidro
> 99% de transmissão

Disipador de aluminio extruido
Dissipador de calor em alumínio extrudado



QMP1040N7



QMP1040G7



CONECTOR ESTANCO INCLUIDO
LIGADOR ESTANQUE INCLUIDO

*Otros acabados a consultar / Para outros acabamentos consultar

PALAU

PREMIUM QMP1040

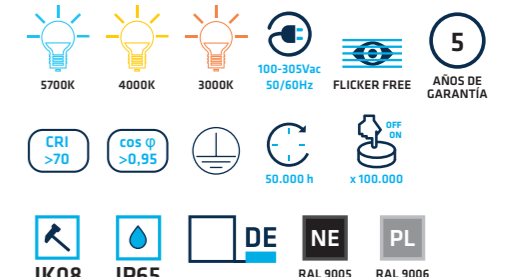

• Material



• Opc. de Reg.



• Certif.



THREELINE
170lm/W reales
170lm/W reais

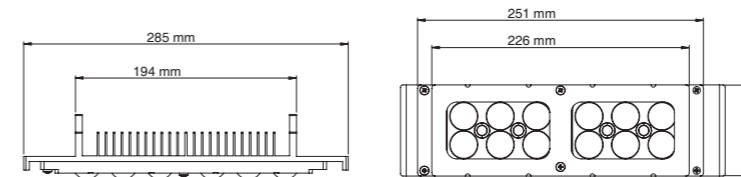

*Genera tu referencia / Gere a sua referência

III III	🔍	CRI	CCT	📐	🔄
QMP1040	■ N	>70	7	● 5700K 57	45° 04 Sin regulación M0
	■ G			● 4000K 40	60° 06 1-10V M1
				● 3000K 30	120° 12 Dali M2

W	CCT	📐	🔄
40 W	● 5700K	8000 lm	6800 lm
	● 4000K	7840 lm	6664 lm
	● 3000K	7600 lm	6460 lm

*Otros acabados a consultar / Para outros acabamentos consultar

PANAMA

PREMIUM PQM

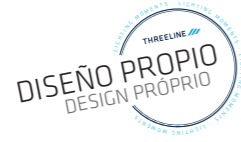

200lm/W

Soporte frontal de aluminio
Suporte frontal de alumínio

Lentes de cristal >99%
de transmisión
Lentes de vidro >99%
de transmissão

Ángulo de inclinación
regulable
Ângulo de inclinação
regulável

• Certif.



LED de alta luminosidad 7070
(200lm/w)
LED de alta luminosidade 7070
(200lm/w)

Cuerpo de aluminio lacado
Corpo em alumínio lacado



Tornillería de acero inoxidable
Parafusos em aço inoxidável



CONECTOR ESTANCO INCLUIDO
LIGADOR ESTANQUE INCLUIDO

PANAMA. ACCESORIOS / ACESSÓRIOS

SENSOR DE MOVIMIENTO



KE KIT DE EMERGENCIA EXTERNO IP65



Indicar la distancia requerida entre el proyector y el kit de emergencia. (Máx. 2m).
Será necesario indicar a distância solicitada entre o projetor e o kit de emergência. (Máx. 2m).

*Otros acabados a consultar / Para outros acabamentos consultar

PANAMA

PQM PREMIUM

8.000lm



40W PQM104NN7

16.000lm



80W PQM208NN7

24.000lm



120W PQM312NN7

40.000lm



200W PQM520NN7

32.000lm



160W PQM416NN7

PANAMA

PREMIUM PQM104NN7

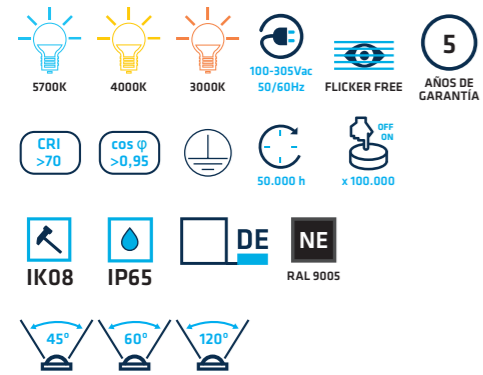

• Material



• Opc. de Reg.



• Opcional



• Certif.



170lm/W reales
170lm/W reais

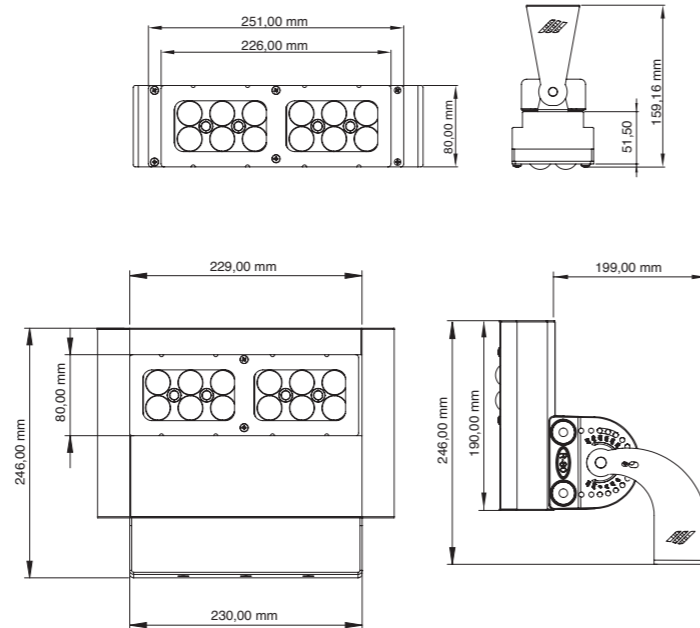

*Genera tu referencia / Gere a sua referência

W	CCT	Beam	Beam	Beam	Beam	OPCIONAL
40 W	5700K	57	45°	04	Sin regulación	M0
	4000K	40	60°	06	0/1-10V	M1
	3000K	30	120°	12	Dali	M2
						Kit de Emergencia U

*Otros acabados a consultar / Para outros acabamentos consultar

PANAMA

PREMIUM PQM208NN7

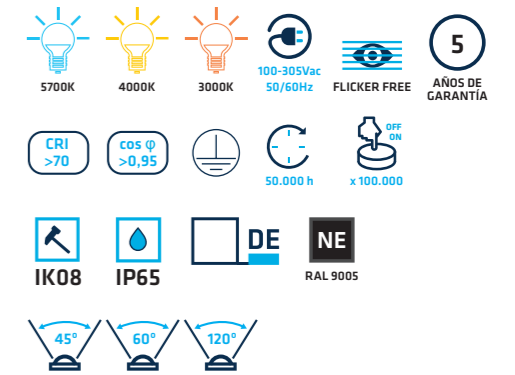

• Material



• Opc. de Reg.



• Opcional



• Certif.



170lm/W reales
170lm/W reais

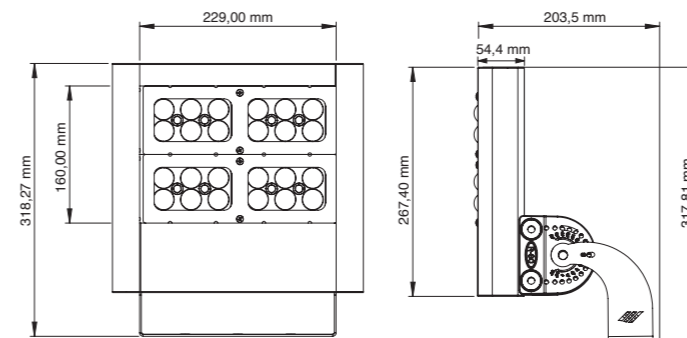

*Genera tu referencia / Gere a sua referência

W	CCT	Beam	Beam	Beam	Beam	OPCIONAL
80 W	5700K	57	45°	04	Sin regulación	M0
	4000K	40	60°	06	0/1-10V	M1
	3000K	30	120°	12	Dali	M2
						Kit de Emergencia U
						Sensor de movimiento P

*Otros acabados a consultar / Para outros acabamentos consultar

PANAMA

PREMIUM PQM312NN7

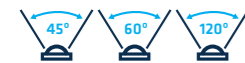
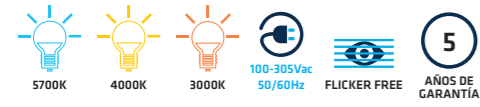

• Material



• Opc. de Reg.



• Opcional



• Certif.



170lm/W reales
170lm/W reais

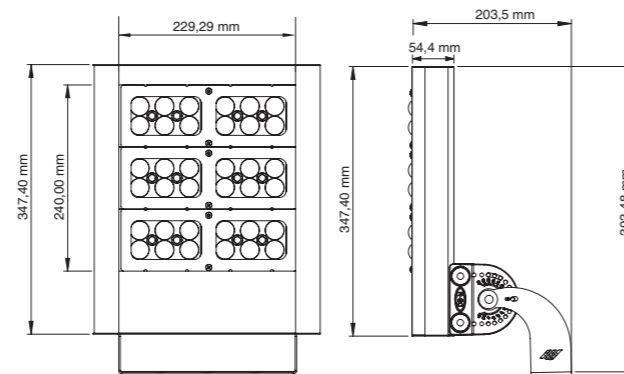

*Genera tu referencia / Gere a sua referência

IIIIII	CCT	Beam	Reg.	Material	OPCIONAL	W	CCT	Beam	Reg.
PQM312NN7	5700K	57	45°	04	Sin regulación	M0	120 W	5700K	24000 lm
	4000K	40	60°	06	0/1-10V	M1		4000K	23520 lm
	3000K	30	120°	12	Dali	M2		3000K	22800 lm
					Kit de Emergencia	U			20400 lm
					Sensor de movimiento	P			19992 lm
									19380 lm

*Otros acabados a consultar / Para outros acabamentos consultar

PANAMA

PREMIUM PQM416NN7

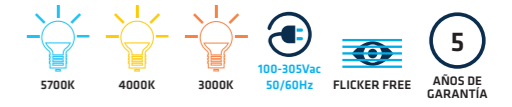

• Material



• Opc. de Reg.



• Opcional



• Certif.



170lm/W reales
170lm/W reais

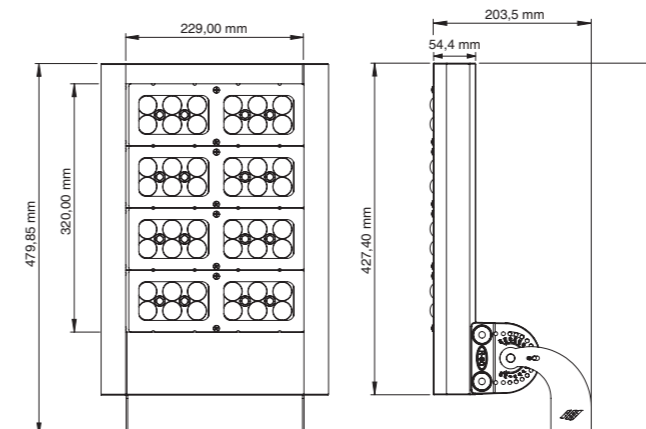

*Genera tu referencia / Gere a sua referência

IIIIII	CCT	Beam	Reg.	Material	OPCIONAL	W	CCT	Beam	Reg.
PQM416NN7	5700K	57	45°	04	Sin regulación	M0	160 W	5700K	32000 lm
	4000K	40	60°	06	0/1-10V	M1		4000K	31360 lm
	3000K	30	120°	12	Dali	M2		3000K	30400 lm
					Kit de Emergencia	U			27200 lm
					Sensor de movimiento	P			26656 lm
									25840 lm

*Otros acabados a consultar / Para outros acabamentos consultar

PANAMA

PREMIUM PQM520NN7

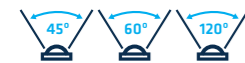
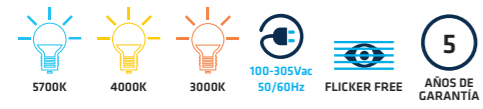

• Material



• Opc. de Reg.



• Opcional



• Certif.



170lm/W reales
170lm/W reais

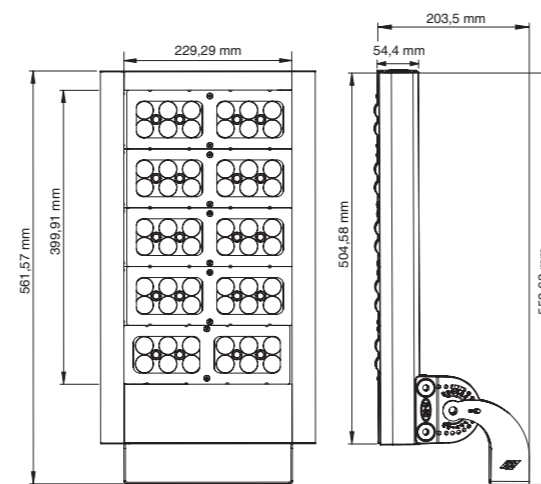

*Genera tu referencia / Gere a sua referência

III III	CCT	Beam	Angle	Reg.	Opt.	W	CCT	Beam	Angle
PQM520NN7	5700K	57	45°	04	Sin regulación	M0	200 W	5700K	40000 lm
	4000K	40	60°	06	0/1-10V	M1		4000K	39200 lm
	3000K	30	120°	12	Dali	M2		3000K	38000 lm
									34000 lm
									33320 lm
									32300 lm

*Otros acabados a consultar / Para outros acabamentos consultar

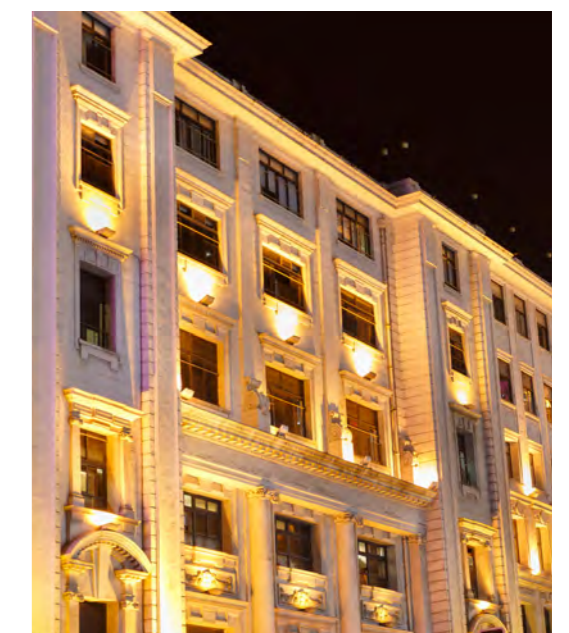

NEW
OLYMPIC II

- PREMIUM
- 5700K 4000K
- IK08 IP66
- 5 AÑOS DE GARANTÍA
- NE
- 1500 W 1800 W
- Certif. CE



Óptima gestión térmica
Ótima regulação térmica

150lm/W reales/reais

Funda metálica de protección para el cable
Fundo metálico de proteção para o cabo

Disipador / Dissipador
Fabricado en aleación de aluminio ADC12
Fabricado em liga de alumínio ADC12

Más ligero
Mais leve

Protector contra sobretensiones 10kv
Proteção contra sobretensão 10kv

Caja estanca IP65
Caixa estanque IP65
Posibilidad de instalación remota del driver
Possibilidade de instalar o driver remotamente

Diseño para reducir la resistencia al viento
Design para reduzir a resistência ao vento

LED de alta luminosidad 5050
LED de alta luminosidade 5050

Lente con >95% de transmisión
IK10 Lente com > 95% de transmissão

Recubrimiento de pintura en polvo
Cobertura com pintura a pó

Asa incluida.
Asa incluída.

Accesorio para mástil opcional
Acessório para mastro opcional
Ref. AMOLPII

Base regulable opcional
Base ajustável opcional
Ref. BROLPII

Marcado del ángulo de inclinación.
Instalación fácil y precisa
Indicador do ângulo de inclinação.
Regulação fácil e precisa



O LP1500 / O LP1800

OLYMPIC II. ACCESORIOS / ACESSÓRIOS



Láser de posicionamiento
Laser de posicionamento
Ref. LOLP

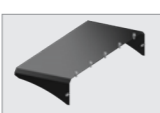

Cubierta reductora del FHS
(Flujo Hemisférico superior)
Cobertura redutora do FHS
(Fluxo hemisférico superior)
Ref. COLPII-B

NEW
OLYMPIC II

150lm/W reales/reais

Óptima gestión térmica
Ótima regulação térmica

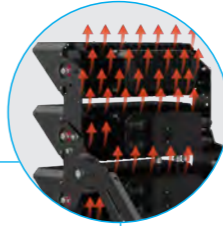

Disipador / Dissipador
Fabricado en aleación de aluminio ADC12
Fabricado em liga de alumínio ADC12

Más ligero
Mais leve

Un driver por cada módulo
Um driver por cada módulo

LED de alta luminosidad 5050
LED de alta luminosidade 5050

Lente con >95% de transmisión
IK10 Lente com > 95% de transmissão

Diseño para reducir la resistencia al viento
Design para reduzir a resistência ao vento

+30°
-30°

Recubrimiento de pintura en polvo
Cobertura com pintura a pó

IP66

Marcado del ángulo de inclinación.
Instalación fácil y precisa
Indicador do ângulo de inclinação.
Regulação fácil e precisa

OLYMPIC II. ACCESORIOS / ACESSÓRIOS



Láser de posicionamiento
Laser de posicionamento
Ref. LOLP

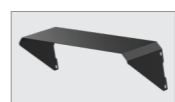

Cubierta reductora del FHS
(Flujo Hemisférico superior)
Cobertura redutora do FHS
(Fluxo hemisférico superior)
Ref. COLPII-A



O LP0300



O LP0600



O LP0900



O LP1200

OLYMPIC II

PRE-MIUM OLP0300

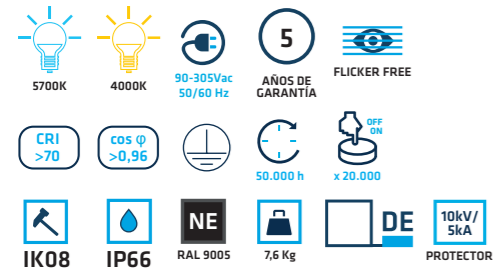

• Material



• Opc. de Reg.



• Opcional



• Ángulos

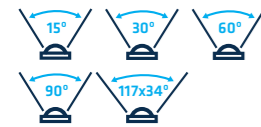

• Certif.

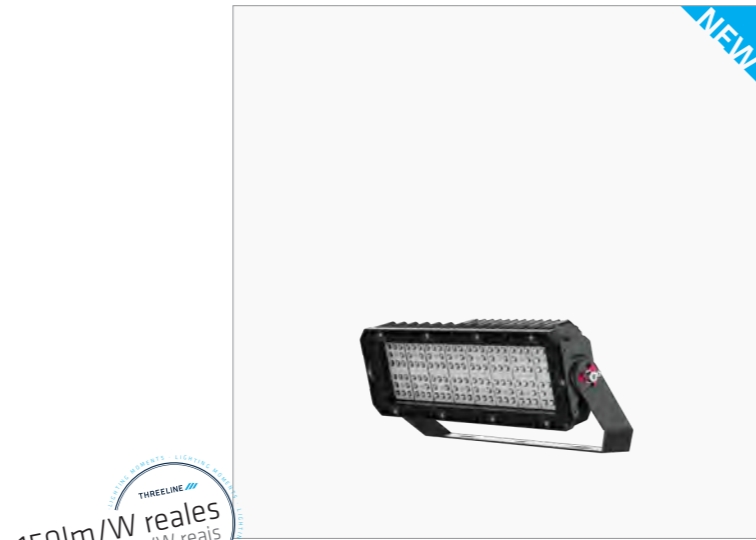

THREELINE
150lm/W reales
150lm/W reais

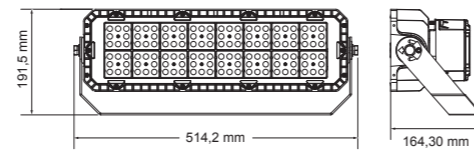

OLYMPIC II

PRE-MIUM OLP0600

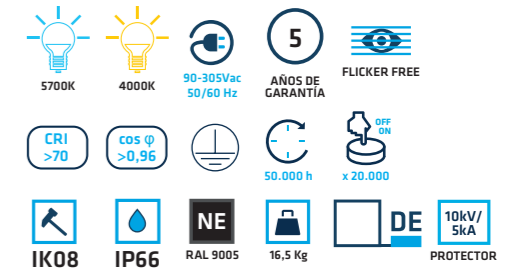

• Material



• Opc. de Reg.



• Opcional



• Ángulos

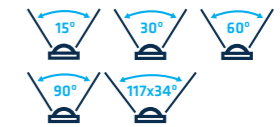

• Certif.

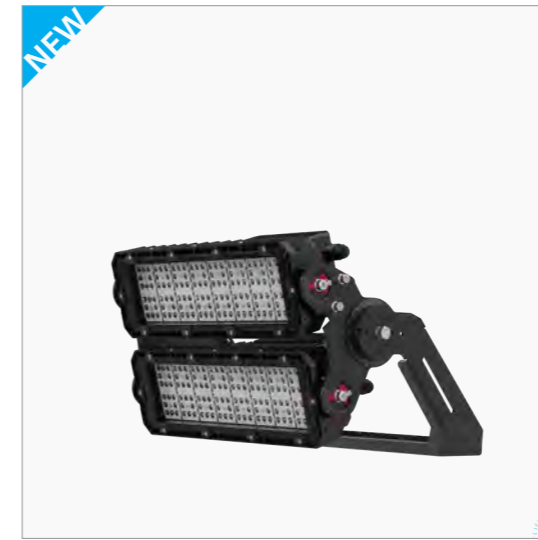

THREELINE
150lm/W reales
150lm/W reais

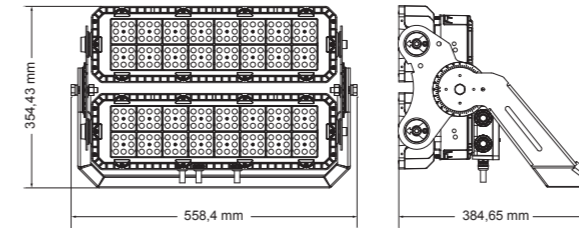

IIIIII	OPCIONES	CCT	W	☀	☀	β
OLP03005715	*	● 5700K	300 W	42000 lm	36000 lm	15°
OLP03004015	*	● 4000K	300 W	42000 lm	36000 lm	15°
OLP03005730	*	● 5700K	300 W	51000 lm	45000 lm	30°
OLP03004030	*	● 4000K	300 W	51000 lm	45000 lm	30°
OLP03005760	*	● 5700K	300 W	51000 lm	45000 lm	60°
OLP03004060	*	● 4000K	300 W	51000 lm	45000 lm	60°
OLP03005790	*	● 5700K	300 W	51000 lm	45000 lm	90°
OLP03004090	*	● 4000K	300 W	51000 lm	45000 lm	90°
OLP030057A16	*	● 5700K	300 W	51000 lm	45000 lm	117x34°
OLP030040A16	*	● 4000K	300 W	51000 lm	45000 lm	117x34°

* Opc. de Reg.

D1 0/1-10V D2 DALI

IIIIII	OPCIONES	CCT	W	☀	☀	β
OLP06005715	*	● 5700K	600 W	84000 lm	72000 lm	15°
OLP06004015	*	● 4000K	600 W	84000 lm	72000 lm	15°
OLP06005730	*	● 5700K	600 W	102000 lm	90000 lm	30°
OLP06004030	*	● 4000K	600 W	102000 lm	90000 lm	30°
OLP06005760	*	● 5700K	600 W	102000 lm	90000 lm	60°
OLP06004060	*	● 4000K	600 W	102000 lm	90000 lm	60°
OLP06005790	*	● 5700K	600 W	102000 lm	90000 lm	90°
OLP06004090	*	● 4000K	600 W	102000 lm	90000 lm	90°
OLP060057A16	*	● 5700K	600 W	102000 lm	90000 lm	117x34°
OLP060040A16	*	● 4000K	600 W	102000 lm	90000 lm	117x34°

* Opc. de Reg.

D1 0/1-10V D2 DALI

OLYMPIC II

PRE-MIUM OLP0900

- 5700K 4000K 90-305Vac 50/60 Hz
- 5 AÑOS DE GARANTÍA
- FLICKER FREE
- CRI >70
- cos φ >0,96
- 50.000 h
- x 20.000
- IK08
- IP66
- RAL 9005
- 23 Kg
- DE
- 10kV/5kA PROTECTOR

• Material

V AL PC
DIFUSOR CUERPO ÓPTICA

• Opc. de Reg.

0/1-10V DALI 0-10V/DA Ref. ZIGBEE-010V 0-10V/DA Ref. CSB110DA 0-10V/DA Ref. DMX-010V

• Opcional

Ref. LOLP Ref. COLPII-A

• Ángulos

15° 30° 60°
90° 117x34°

• Certif.

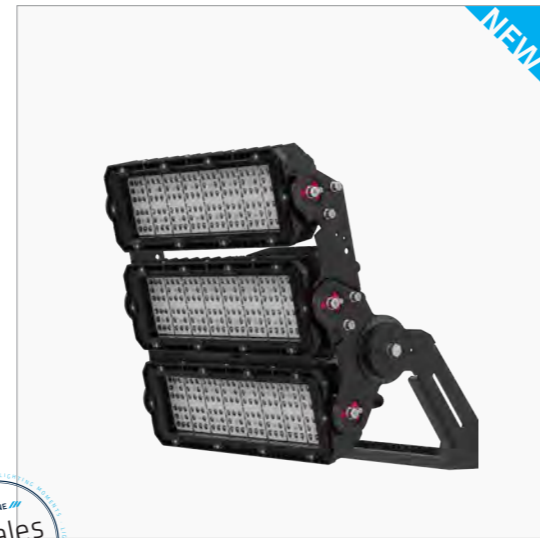

THREELINE
150lm/W reales
150lm/W reais

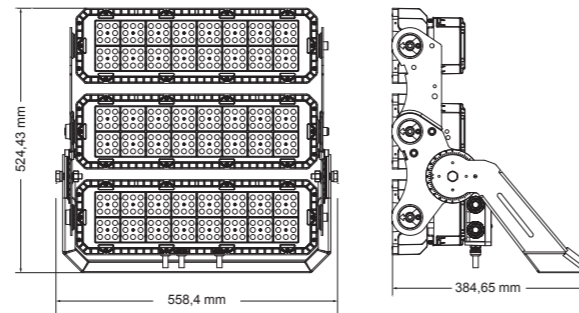

OLYMPIC II

PRE-MIUM OLP1200

- 5700K 4000K 90-305Vac 50/60 Hz
- 5 AÑOS DE GARANTÍA
- FLICKER FREE
- CRI >70
- cos φ >0,96
- 50.000 h
- x 20.000
- IK08
- IP66
- RAL 9005
- 29 Kg
- DE
- 10kV/5kA PROTECTOR

• Material

V AL PC
DIFUSOR CUERPO ÓPTICA

• Opc. de Reg.

0/1-10V DALI 0-10V/DA Ref. ZIGBEE-010V 0-10V/DA Ref. CSB110DA 0-10V/DA Ref. DMX-010V

• Opcional

Ref. LOLP Ref. COLPII-A

• Ángulos

15° 30° 60°
90° 117x34°

• Certif.



THREELINE
150lm/W reales
150lm/W reais

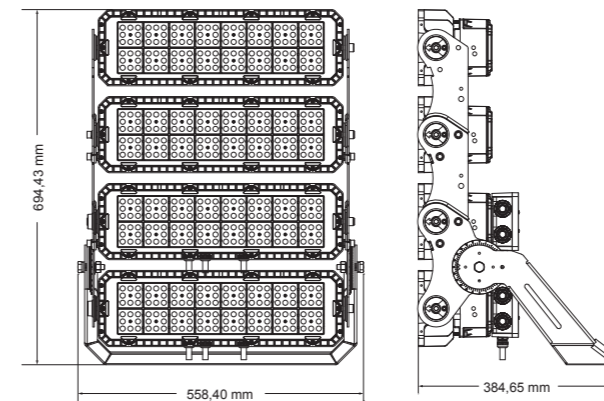

OPCIONES	CCT	W	15°	30°	β
* 5700K	900 W	126000 lm	108000 lm	15°	
* 4000K	900 W	126000 lm	108000 lm	15°	
* 5700K	900 W	153000 lm	135000 lm	30°	
* 4000K	900 W	153000 lm	135000 lm	30°	
* 5700K	900 W	153000 lm	135000 lm	60°	
* 4000K	900 W	153000 lm	135000 lm	60°	
* 5700K	900 W	153000 lm	135000 lm	90°	
* 4000K	900 W	153000 lm	135000 lm	90°	
* 5700K	900 W	153000 lm	135000 lm	117x34°	
* 4000K	900 W	153000 lm	135000 lm	117x34°	

* Opc. de Reg.

D1 0/1-10V D2 DALI

OPCIONES	CCT	W	15°	30°	β
* 5700K	1200 W	168000 lm	144000 lm	15°	
* 4000K	1200 W	168000 lm	144000 lm	15°	
* 5700K	1200 W	204000 lm	180000 lm	30°	
* 4000K	1200 W	204000 lm	180000 lm	30°	
* 5700K	1200 W	204000 lm	180000 lm	60°	
* 4000K	1200 W	204000 lm	180000 lm	60°	
* 5700K	1200 W	204000 lm	180000 lm	90°	
* 4000K	1200 W	204000 lm	180000 lm	90°	
* 5700K	1200 W	204000 lm	180000 lm	117x34°	
* 4000K	1200 W	204000 lm	180000 lm	117x34°	

* Opc. de Reg.

D1 0/1-10V D2 DALI

OLYMPIC II

PRE-MIUM OLP1500

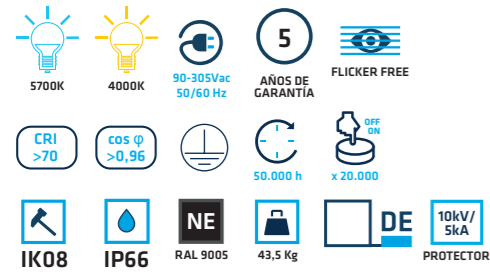

• Material • Certif.



• Incluido



• Opc. de Reg.



• Opcional



• Ángulos

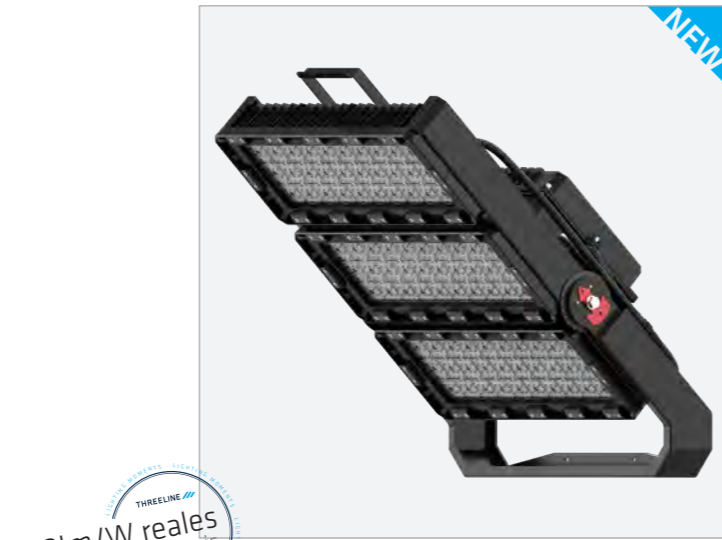
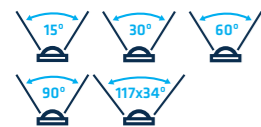

THREELINE
150lm/W reales
150lm/W reais

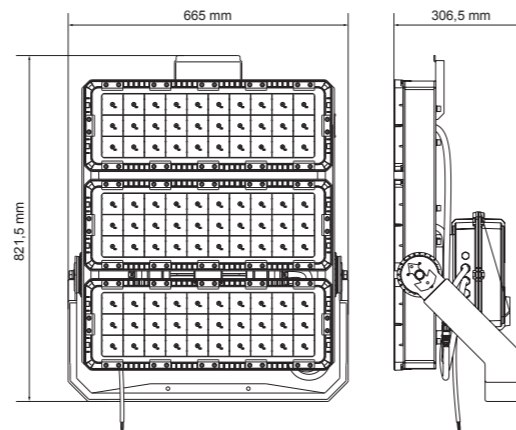

IIIIII	OPCIONES	CCT	W	☀	☀	β
OLP15005715	*	● 5700K	1500 W	210000 lm	180000 lm	15°
OLP15004015	*	● 4000K	1500 W	210000 lm	180000 lm	15°
OLP15005730	*	● 5700K	1500 W	255000 lm	225000 lm	30°
OLP15004030	*	● 4000K	1500 W	255000 lm	225000 lm	30°
OLP15005760	*	● 5700K	1500 W	255000 lm	225000 lm	60°
OLP15004060	*	● 4000K	1500 W	255000 lm	225000 lm	60°
OLP15005790	*	● 5700K	1500 W	255000 lm	225000 lm	90°
OLP15004090	*	● 4000K	1500 W	255000 lm	225000 lm	90°
OLP150057A16	*	● 5700K	1500 W	255000 lm	225000 lm	117x34°
OLP150040A16	*	● 4000K	1500 W	255000 lm	225000 lm	117x34°

* Opc. de Reg.

D1 0/1-10V D2 DALI

OLYMPIC II

PRE-MIUM OLP1800

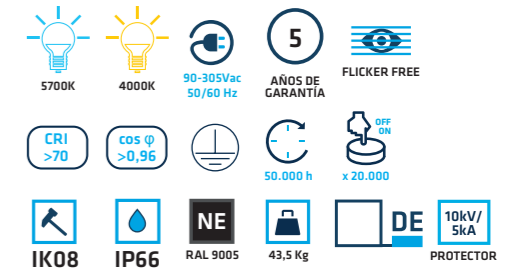

• Material



• Incluido



• Opc. de Reg.



• Opcional



• Ángulos

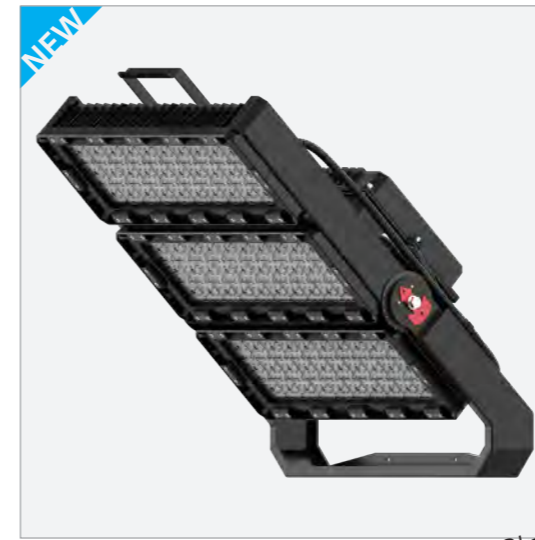
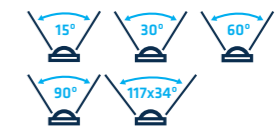

THREELINE
150lm/W reales
150lm/W reais

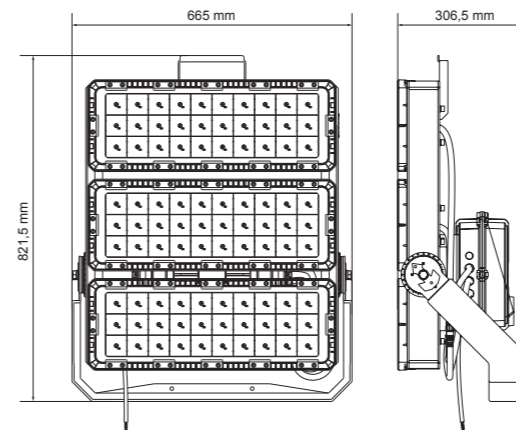

IIIIII	OPCIONES	CCT	W	☀	☀	β
OLP18005715	*	● 5700K	1800 W	252000 lm	216000 lm	15°
OLP18004015	*	● 4000K	1800 W	252000 lm	216000 lm	15°
OLP18005730	*	● 5700K	1800 W	306000 lm	270000 lm	30°
OLP18004030	*	● 4000K	1800 W	306000 lm	270000 lm	30°
OLP18005760	*	● 5700K	1800 W	306000 lm	270000 lm	60°
OLP18004060	*	● 4000K	1800 W	306000 lm	270000 lm	60°
OLP18005790	*	● 5700K	1800 W	306000 lm	270000 lm	90°
OLP18004090	*	● 4000K	1800 W	306000 lm	270000 lm	90°
OLP180057A16	*	● 5700K	1800 W	306000 lm	270000 lm	117x34°
OLP180040A16	*	● 4000K	1800 W	306000 lm	270000 lm	117x34°

* Opc. de Reg.

D1 0/1-10V D2 DALI

NEW
LYON

PRO PRL



• Certif.



140lm/W
reales/reais

Cristal templado de 4 mm
Vidro temperado 4 mm IK08

LED de alta luminosidad
LED ultraluminosos

Reflector de policarbonato
Refletor em policarbonato

Tornillería en acero inoxidable
Fecho clip em aço inoxidável

Driver 110-240Vac
Driver 110-240Vac

Asa de acero SPCC
Suporte SPCC

Fabricado en aleación de aluminio ADC12
Fabricado em liga de alumínio ADC12

20 W	30 W	50 W	80 W	100 W
150 W	200 W	240 W	300 W	400 W



Óptima gestión térmica
Ótima regulação térmica



Diseñado para evitar la
acumulación de suciedad
Desenvolvido para evitar a
acumulação de lixo e poeiras.

Marcado del ángulo de inclinación.
Instalación fácil y precisa
Indicador do ângulo de inclinação.
Regulação fácil e precisa

Conector rápido estanco*
Ligação rápida à prova de água*

Válvula anticondesación
Válvula anticondensação

Múltiples opciones de regulación
Várias opções de regulação



Opción de instalar sensor de
movimiento o de luminosidad.
Opção de incluir sensor de
movimento e de luz.

*Incluido a partir de 100W / *Incluído a partir de 100W

LYON. APLICACIONES DEPORTIVAS

PRO PRL

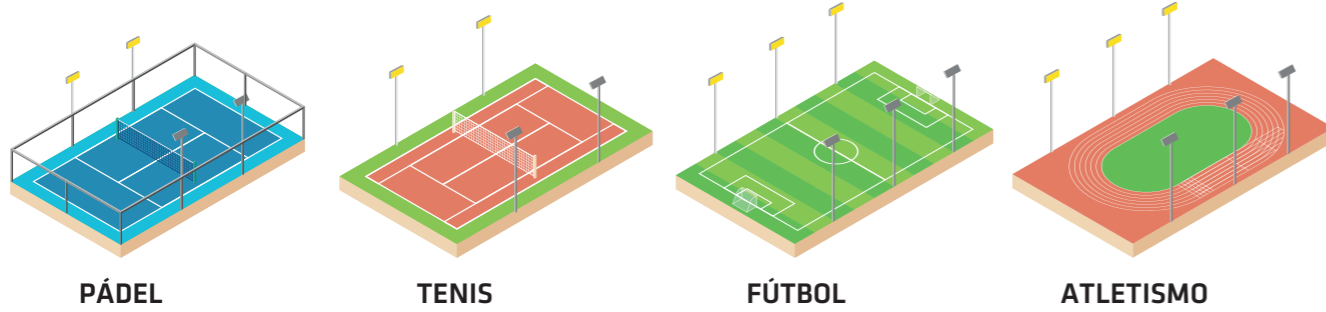
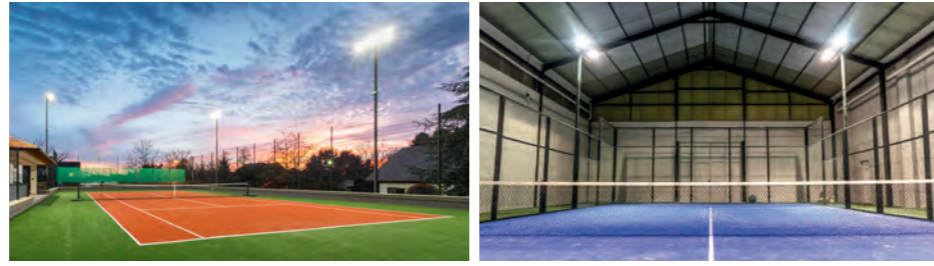

Modelo estándar con cristal frost en 120°
Modelo standard com vidro fosco de 120°

Lentes personalizadas
Lentes personalizáveis



SIMÉTRICAS / SIMÉTRICAS

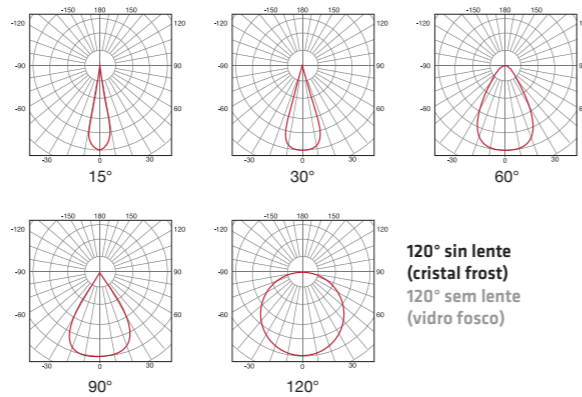

ASIMÉTRICAS / ASSIMÉTRICAS

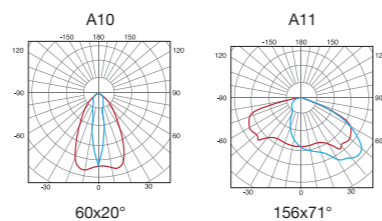

LYON

PRO PRL020 / PRL030

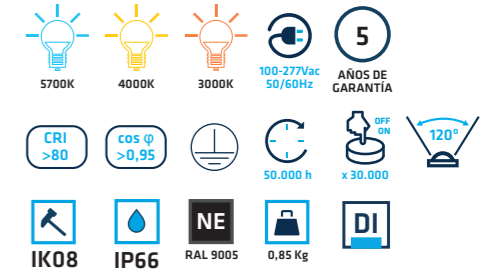

• Material



• Opc. de Reg.



• Opcional



• Certif.

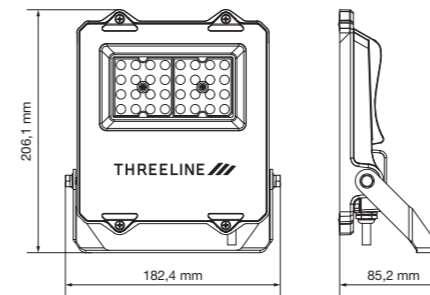

III III	OPCIONES	W	CCT	N	III III
PRL02057120	*	20 W	● 5700K	3200 lm	2800 lm
PRL02040120	*	20 W	● 4000K	3200 lm	2800 lm
PRL02030120	*	20 W	● 3000K	3140 lm	2700 lm
PRL03057120	*	30 W	● 5700K	4800 lm	4200 lm
PRL03040120	*	30 W	● 4000K	4800 lm	4200 lm
PRL03030120	*	30 W	● 3000K	4710 lm	4050 lm

• Opc. de Lente

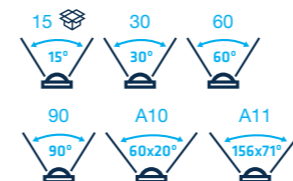

* Opc. de Reg.

AC 12-24Vac
DC 12-24Vdc

* Opcional

S1 Sensor de Movimiento IP65
E Kit de Emergencia
AV Rejilla Antivandálica

LYON

PRO PRL050 / PRL080

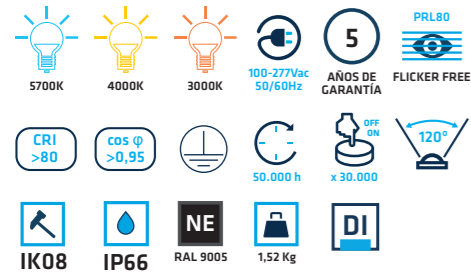

• Material



• Opc. de Reg. / Clase

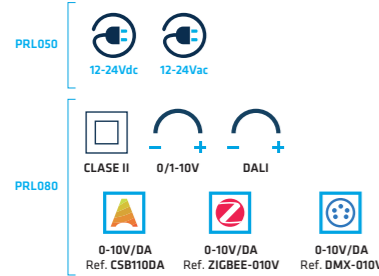

• Opcional



• Certif.

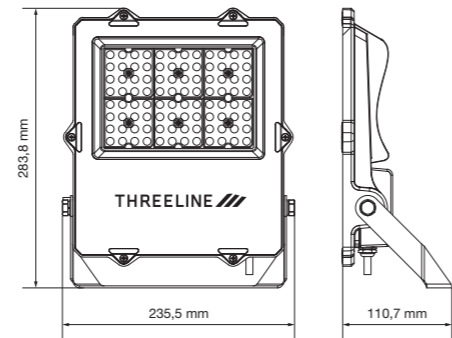

OPCIONES	W	CCT	8000 lm	7000 lm
PRL05057120 *	50 W	5700K	8000 lm	7000 lm
PRL05040120 *	50 W	4000K	8000 lm	7000 lm
PRL05030120 *	50 W	3000K	7850 lm	6750 lm
PRL08057120 *	80 W	5700K	12800 lm	11200 lm
PRL08040120 *	80 W	4000K	12800 lm	11200 lm
PRL08030120 *	80 W	3000K	12560 lm	10800 lm

• Opc. de Lente

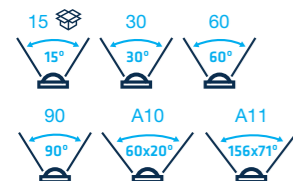

* Opc. de Reg. / Clase

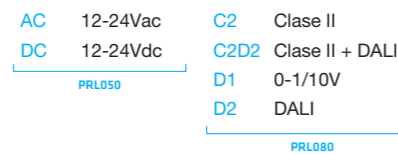

* Opcional

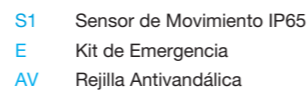

LYON

PRO PRL100 / PRL150

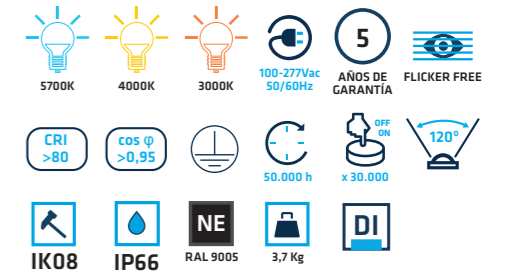

• Material



• Opc. de Reg. / Clase

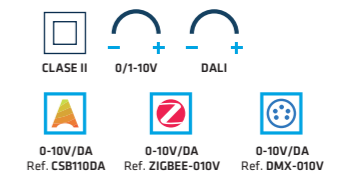

• Incluido



• Opcional



• Certif.

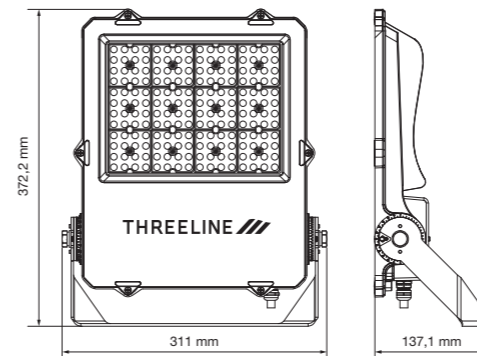

OPCIONES	W	CCT	16000 lm	14000 lm
PRL10057120 *	100 W	5700K	16000 lm	14000 lm
PRL10040120 *	100 W	4000K	16000 lm	14000 lm
PRL10030120 *	100 W	3000K	15700 lm	13500 lm
PRL15057120 *	150 W	5700K	24000 lm	21000 lm
PRL15040120 *	150 W	4000K	24000 lm	21000 lm
PRL15030120 *	150 W	3000K	23550 lm	20250 lm

• Opc. de Lente



* Opc. de Reg. / Clase



* Opcional

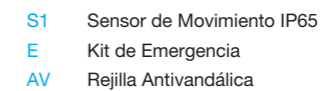

LYON

PRO PRL200 / PRL240

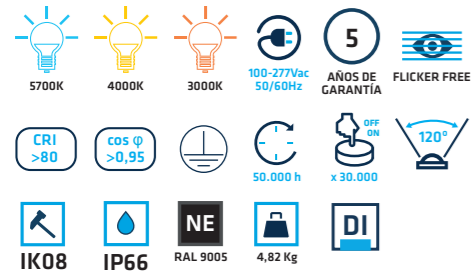

• Material



• Opc. de Reg. / Clase

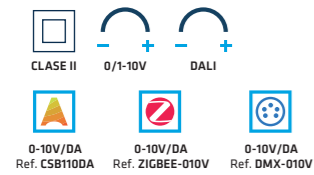

• Incluido



• Opcional



• Certif.



140lm/W reales
140lm/W reais

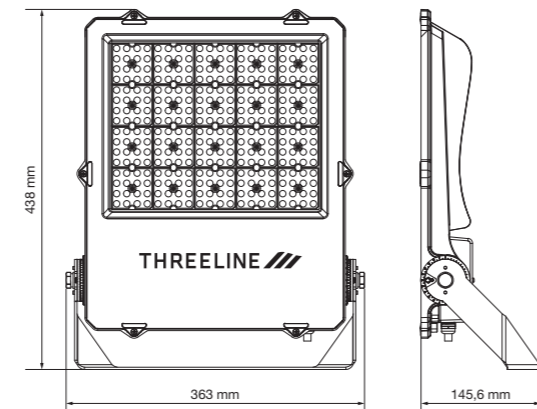

OPCIONES	W	CCT	30°	60°
PRL20057120 *	200 W	5700K	32000 lm	28000 lm
PRL20040120 *	200 W	4000K	32000 lm	28000 lm
PRL20030120 *	200 W	3000K	31400 lm	27000 lm
PRL24057120 *	240 W	5700K	38400 lm	33600 lm
PRL24040120 *	240 W	4000K	38400 lm	33600 lm
PRL24030120 *	240 W	3000K	37680 lm	32400 lm

• Opc. de Lente

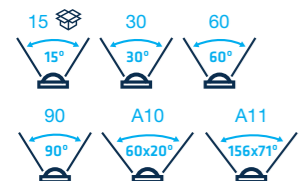

* Opc. de Reg. / Clase

- C2 Clase II
- C2D2 Clase II + DALI
- D1 0-1/10V
- D2 DALI

* Opcional

- S1 Sensor de Movimiento IP65
- E Kit de Emergencia
- AV Rejilla Antivandálica

LYON

PRO PRL300 / PRL400

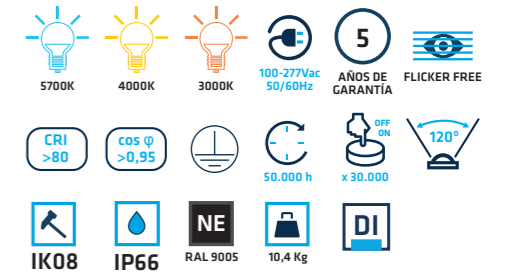

• Material



• Opc. de Reg. / Clase

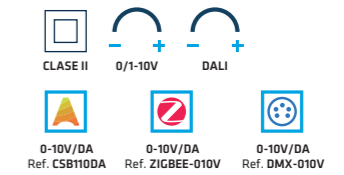

• Incluido



• Opcional



• Certif.



140lm/W reales
140lm/W reais

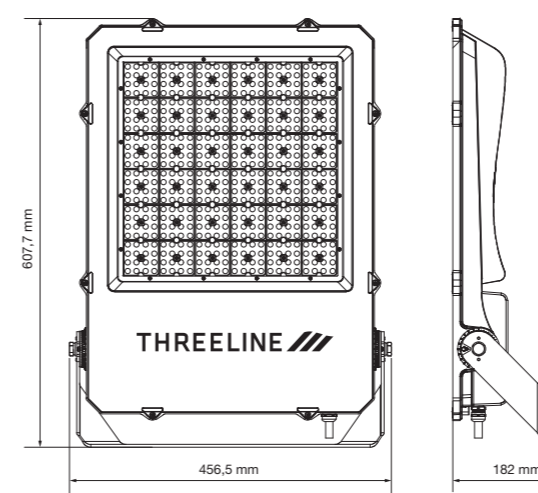

OPCIONES	W	CCT	30°	60°
PRL30057120 *	300 W	5700K	48000 lm	42000 lm
PRL30040120 *	300 W	4000K	48000 lm	42000 lm
PRL30030120 *	300 W	3000K	47100 lm	40500 lm
PRL40057120 *	400 W	5700K	64000 lm	56000 lm
PRL40040120 *	400 W	4000K	64000 lm	56000 lm
PRL40030120 *	400 W	3000K	62800 lm	54000 lm

• Opc. de Lente

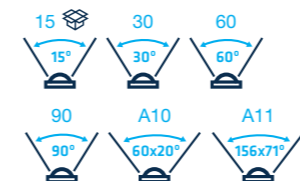

* Opc. de Reg. / Clase

- C2 Clase II
- C2D2 Clase II + DALI
- D1 0-1/10V
- D2 DALI

* Opcional

- S1 Sensor de Movimiento IP65
- E Kit de Emergencia
- AV Rejilla Antivandálica

IPROY

ECO IPRN10W / IPRN20W
IPRN30W / IPRN50W



• Material



• Certif.

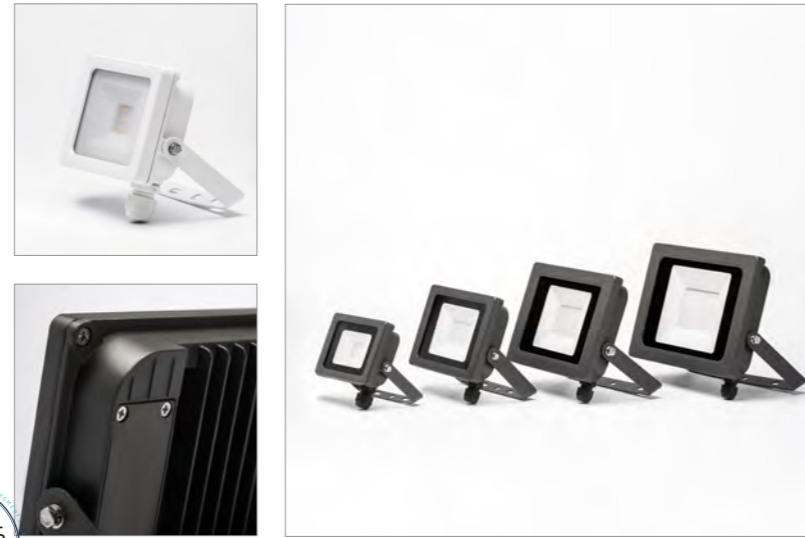

THREELINE //
100lm/W reales
100lm/W reales

	IPRN10W	IPRN20W	IPRN30W	IPRN50W
A	126 mm	161 mm	205 mm	233 mm
B	122,5 mm	156 mm	190 mm	216 mm
C	33,5 mm	33,5 mm	33,5 mm	34,5 mm

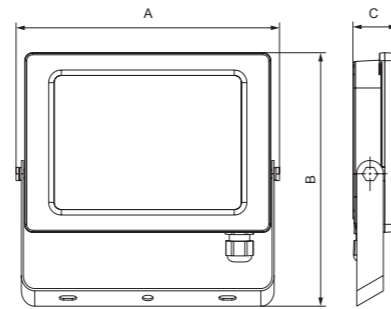

Icon	CCT	W	Beam	lm
IPRN10WBFNE	6500K	10 W	1300 lm	1000 lm
IPRN10WBNNE	4000K	10 W	1300 lm	1000 lm
IPRN10WBCNE	3000K	10 W	1300 lm	1000 lm
IPRN10WBNBL	4000K	10 W	1300 lm	1000 lm
IPRN20WBFNE	6500K	20 W	2600 lm	2000 lm
IPRN20WBNNE	4000K	20 W	2600 lm	2000 lm
IPRN20WBCNE	3000K	20 W	2600 lm	2000 lm
IPRN20WBNBL	4000K	20 W	2600 lm	2000 lm

Icon	CCT	W	Beam	lm
IPRN30WBFNE	6500K	30 W	3900 lm	3000 lm
IPRN30WBNNE	4000K	30 W	3900 lm	3000 lm
IPRN30WBCNE	3000K	30 W	3900 lm	3000 lm
IPRN30WBNBL	4000K	30 W	3900 lm	3000 lm
IPRN50WBFNE	6500K	50 W	6500 lm	5000 lm
IPRN50WBNNE	4000K	50 W	6500 lm	5000 lm
IPRN50WBCNE	3000K	50 W	6500 lm	5000 lm
IPRN50WBNBL	4000K	50 W	6500 lm	5000 lm

IPROY

ECO IPRN100W / IPRN150W
IPRN200W



• Material



• Certif.



	IPRN100W	IPRN150W	IPRN200W
A	330 mm	390 mm	390 mm
B	275 mm	333 mm	190 mm
C	54 mm	59 mm	59 mm

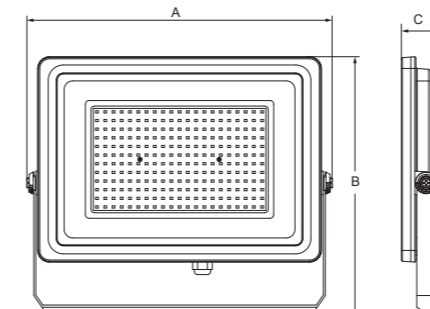

Icon	CCT	W	Beam	lm
IPRN100WBFNE	6500K	100 W	13000 lm	10000 lm
IPRN100WBNNE	4000K	100 W	13000 lm	10000 lm
IPRN100WBCNE	3000K	100 W	13000 lm	10000 lm
IPRN150WBFNE	6500K	150 W	19500 lm	15000 lm
IPRN150WBNNE	4000K	150 W	19500 lm	15000 lm
IPRN200WBFNE	6500K	200 W	30000 lm	20000 lm
IPRN200WBNNE	4000K	200 W	30000 lm	20000 lm

IVO

ECO PRI010 / PRI020 / PRI030

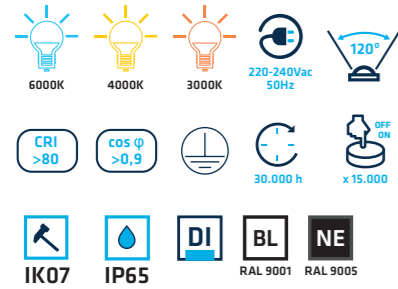

• Material



• Certif.



100lm/W reales
100lm/W reais

	PRI010	PRI020	PRI030
A	125 mm	160 mm	225 mm
B	95 mm	120 mm	160 mm
C	47 mm	49 mm	58 mm

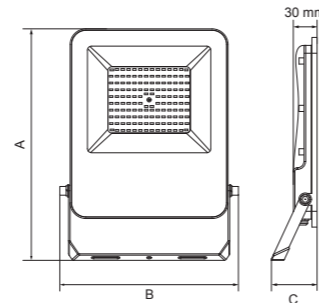

IIIII	CCT	☑	W	☀	☀
PRI010601202	6000K	■	10 W	1100 lm	900 lm
PRI010401202	4000K	■	10 W	1100 lm	900 lm
PRI010301202	3000K	■	10 W	1070 lm	850 lm
PRI010401200	4000K	□	10 W	1100 lm	900 lm
PRI020601202	6000K	■	20 W	2400 lm	2000 lm
PRI020401202	4000K	■	20 W	2400 lm	2000 lm
PRI020301202	3000K	■	20 W	2300 lm	1900 lm
PRI020401200	4000K	□	20 W	2400 lm	2000 lm
PRI030601202	6000K	■	30 W	3600 lm	3000 lm
PRI030401202	4000K	■	30 W	3600 lm	3000 lm
PRI030301202	3000K	■	30 W	3510 lm	2850 lm
PRI030401200	4000K	□	30 W	3600 lm	3000 lm

IVO

ECO PRI050 / PRI100 / PRI150

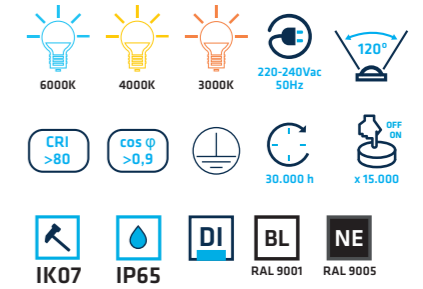

• Material



• Certif.



100lm/W reales
100lm/W reais

	PRI050	PRI100	PRI150
A	250 mm	295 mm	370 mm
B	180 mm	228 mm	228 mm
C	58 mm	58 mm	58 mm

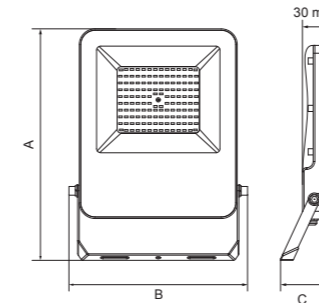

IIIII	CCT	☑	W	☀	☀
PRI050601202	6000K	■	50 W	6000 lm	5000 lm
PRI050401202	4000K	■	50 W	6000 lm	5000 lm
PRI050301202	3000K	■	50 W	5850 lm	4750 lm
PRI050401200	4000K	□	50 W	6000 lm	5000 lm
PRI100601202	6000K	■	100 W	12000 lm	10000 lm
PRI100401202	4000K	■	100 W	12000 lm	10000 lm
PRI150601202	6000K	■	150 W	18000 lm	15000 lm
PRI150401202	4000K	■	150 W	18000 lm	15000 lm



FIUL

PRO FIU060 / FIU100
FIU150 / FIU200

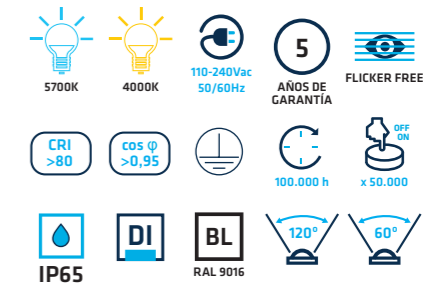

• Material



• Opc. de Reg.



• Certif.

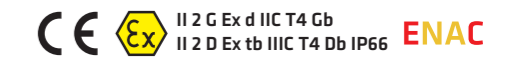

140lm/W reales
140lm/W reais

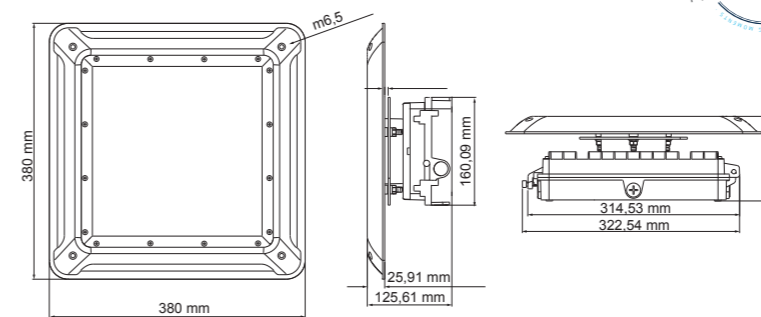

Instalación en superficie
Instalação saliente

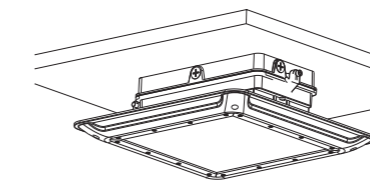

Instalación empotrado
Instalação encastrar

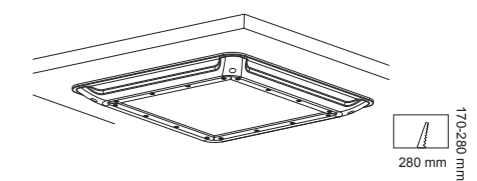

Para cortes de techo que superen el rango 220x360 mm personalizamos el accesorio (Ref.: AFIUE) a medida.
Personalizamos as dimensões do acessório (Ref.: AFUIE) para aberturas no tecto que excedam as dimensões 220x360 mm.

*Genera tu referencia / Gere a sua referência

FIU	W	RA	CCT	Beam	Options	* Opcional:
FIU	60 W	060	RA>70	7	● 5700K 57 ● 4000K 40	120° 120 □ 0 0/1-10V 2
	100 W	100				DALI 3
	150 W	150				
	200 W	200				

KE KE KEU2403

W	CCT	Beam	Beam	W	CCT	Beam	Beam	W	CCT	Beam	Beam	W	CCT	Beam	Beam
60 W	● 5700K 9840 lm 8400 lm ● 4000K 9840 lm 8400 lm			100 W	● 5700K 16400 lm 14000 lm ● 4000K 16400 lm 14000 lm			150 W	● 5700K 24600 lm 21000 lm ● 4000K 24600 lm 21000 lm			200 W	● 5700K 32800 lm 28000 lm ● 4000K 32800 lm 28000 lm		

Luminaria Vial Luminária Vial

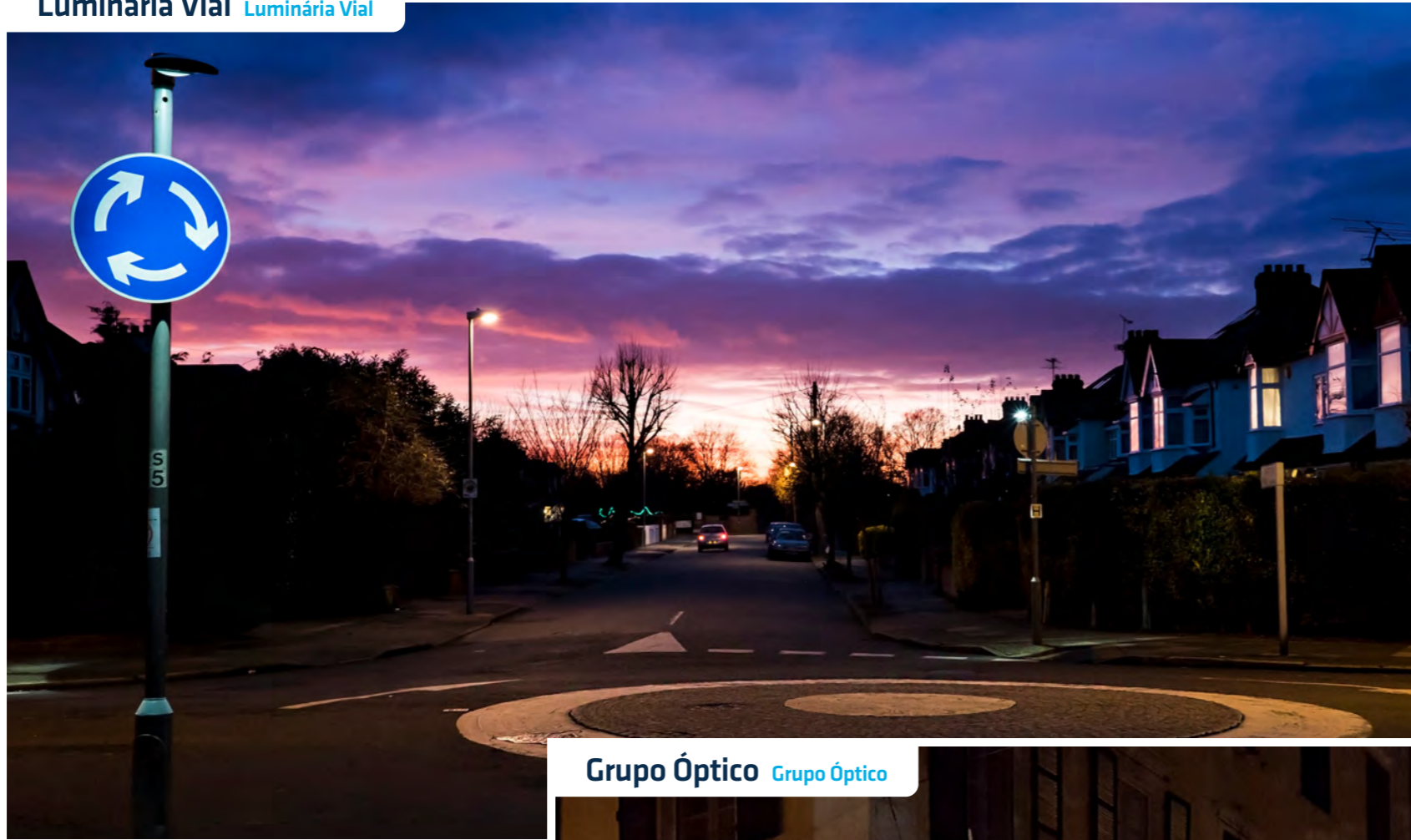

Grupo Óptico Grupo Óptico

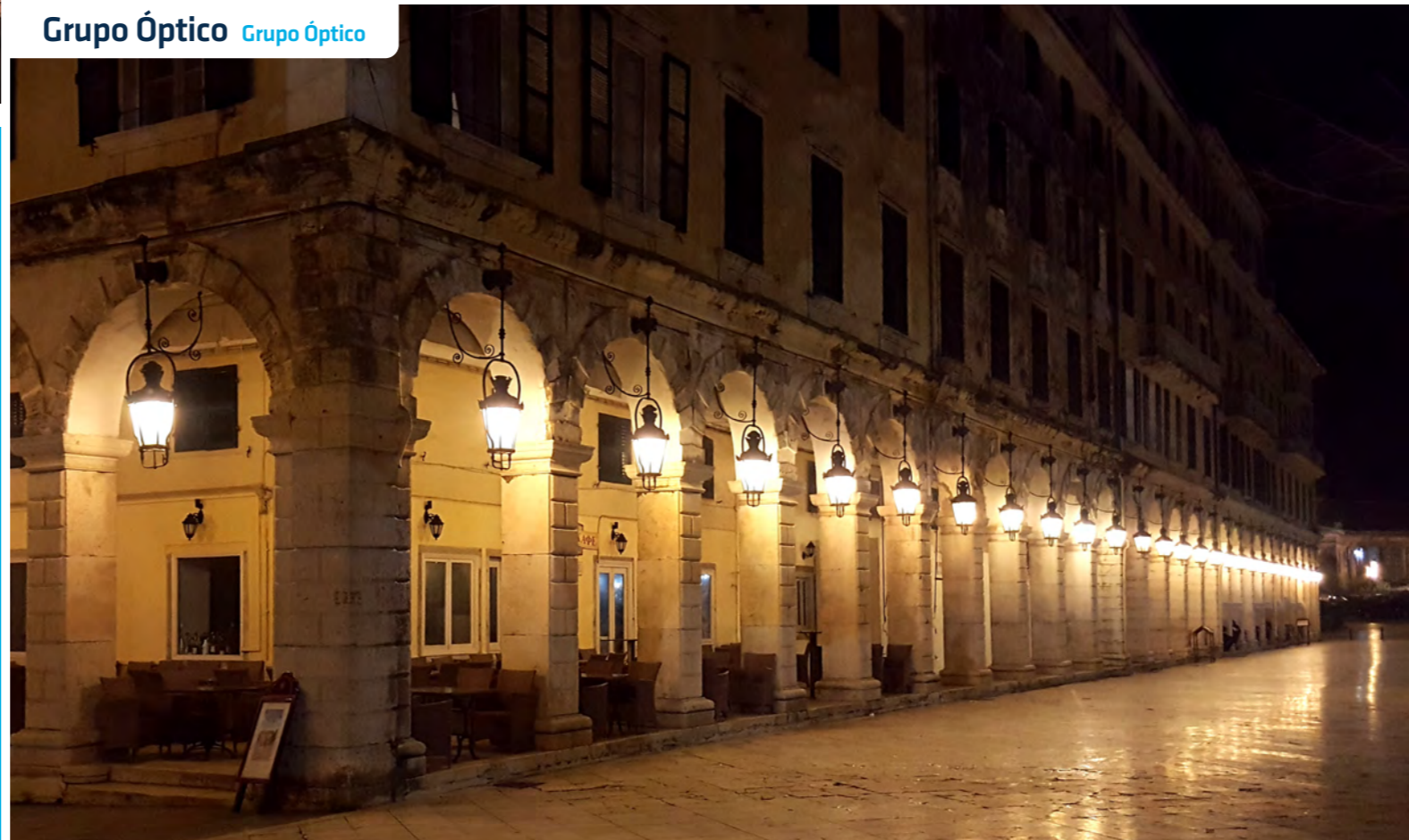

VIAL

Luminaria Vial

Luminária Vial



LUMINARIA VIAL
LUMINÁRIA VIAL

RETROFIT
RETROFIT

GRUPO ÓPTICO
GRUPO ÓPTICO

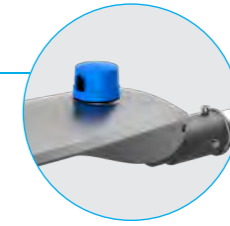

RUA ^{PRO}

5 AÑOS DE GARANTÍA
IP66 IK08

NEW ECO KALE

5 AÑOS DE GARANTÍA
IP66 IK08



PERSONALIZABLE
PERSONALIZÁVEL

NEW VILLA FERNANDINA URBAN ^{PRO}

Hasta 170lm/W reales/reals
5 AÑOS DE GARANTÍA
IP65



PRO NUIT

150lm/W reales/reals
5 AÑOS DE GARANTÍA



VIAL / VIAL

RUA

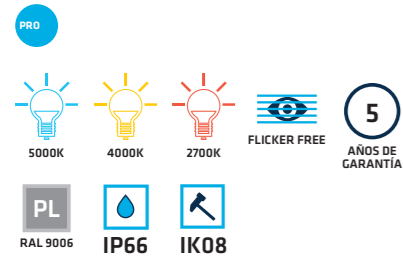

130lm/W
reales/reais

Sistema de apertura
sin herramientas
Sistema de
apertura fácil

Disipador de aleta
Integrado en el molde
Dissipador de varas
integrado no molde

Sistema de fijación
Sistema de fixação

ACV60 Ø 60 mm.



Incluido / Incluído

ACV34 Ø 34 mm.

ACV42 Ø 42 mm.

ACV76 Ø 76 mm.

Opciones de inclinación
Opções de inclinação

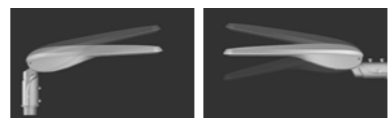

Vertical ±15° rotación / rotação
Horizontal ±15° rotación / rotação

Lente PMMA

Junta de estanqueidad de neopreno
Junta de estanqueidade neopreno

Desconector eléctrico de seguridad
Corte elétrico de segurança

Driver primeras marcas europeas
Driver de qualidade de marcas europeias

Cierre
vidrio templado IK08
Fecho de vidro
templado IK08

Protección contra
sobretensiones 10KV/ 10KA
Protector contra
sobretensão 10KV/KA

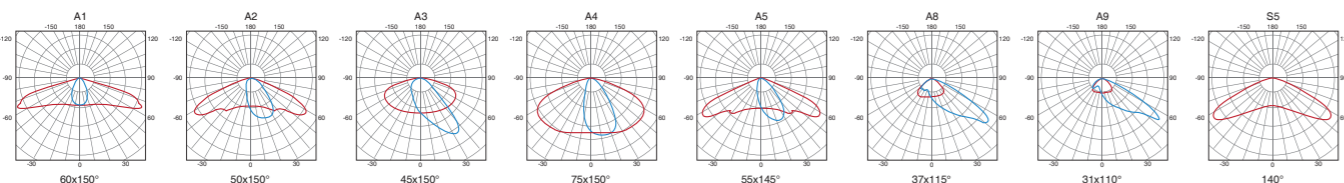

RUA "S"

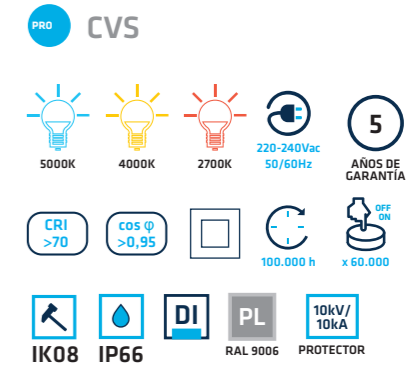

• LED



• Material



• Opc. de Reg.



• Opcional



• Certif.

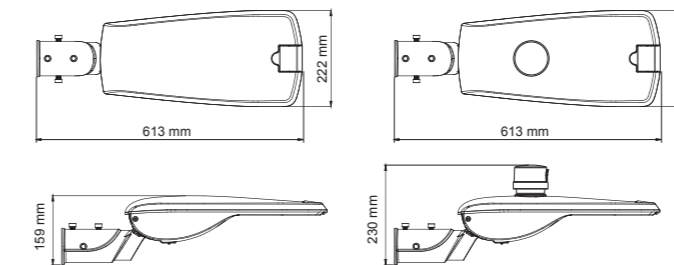

IIIIII	CCT	W	I	N	IIIIII
CVS001.*.**	5000K	20 W	350 mA	3200 lm	2751 lm
CVS002.*.**	4000K	20 W	350 mA	3100 lm	2620 lm
CVS003.*.**	2700K	20 W	350 mA	2810 lm	2410 lm
CVS004.*.**	5000K	30 W	550 mA	4800 lm	4095 lm
CVS005.*.**	4000K	30 W	550 mA	4650 lm	3900 lm
CVS006.*.**	2700K	30 W	550 mA	4188 lm	3588 lm
CVS007.*.**	5000K	40 W	700 mA	6400 lm	5418 lm
CVS008.*.**	4000K	40 W	700 mA	6200 lm	5160 lm
CVS009.*.**	2700K	40 W	700 mA	5560 lm	4747 lm
CVS010.*.**	5000K	50 W	900 mA	8000 lm	6731 lm
CVS011.*.**	4000K	50 W	900 mA	7750 lm	6410 lm
CVS012.*.**	2700K	50 W	900 mA	6900 lm	5897 lm

* Opc. de Lente



** Opc. de Reg.

PH Fotocélula ON/OFF / Fotocélula ON/OFF
 TD5 Telegestión CASAMBI / Telegestão CASAMBI
 SR Sin regulación / Sem regulação
 DN2- Doble nivel sin línea de mando / Duplo nível sem cabo regulador
 DN2+ Doble nivel con línea de mando / Duplo nível com cabo regulador
 DRC Regulación en cabecera / Regulação na cabeça

D110 1-10V
 DA Dali
 DPR Programable / Programável
 DC 12-24Vdc

*CRI>80 bajo pedido / CRI>80 por encomenda

RUA "M"

PRO CVM

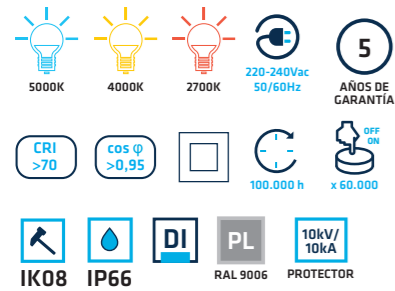

• LED



• Material



• Opc. de Reg.



• Opcional



• Certif.

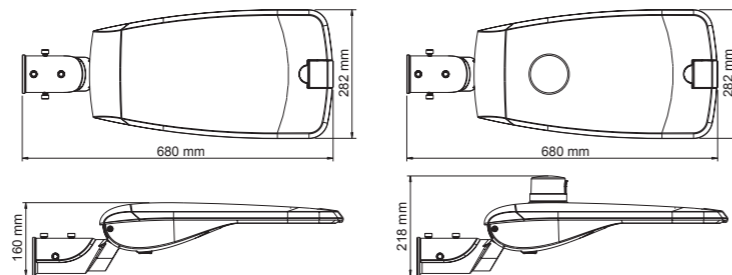

IIIII	CCT	W	I	☀	☀
CVM001.*.**	5000K	50 W	500 mA	8000 lm	6878 lm
CVM002.*.**	4000K	50 W	500 mA	7750 lm	6550 lm
CVM003.*.**	2700K	50 W	500 mA	7091 lm	6091 lm
CVM004.*.**	5000K	60 W	600 mA	9600 lm	8253 lm
CVM005.*.**	4000K	60 W	600 mA	9300 lm	7860 lm
CVM006.*.**	2700K	60 W	600 mA	8435 lm	7310 lm
CVM007.*.**	5000K	70 W	700 mA	11200 lm	9555 lm
CVM008.*.**	4000K	70 W	700 mA	10500 lm	9100 lm
CVM009.*.**	2700K	70 W	700 mA	9870 lm	8463 lm
CVM010.*.**	5000K	80 W	800 mA	12800 lm	10836 lm
CVM011.*.**	4000K	80 W	800 mA	12400 lm	10320 lm
CVM012.*.**	2700K	80 W	800 mA	11200 lm	9597 lm
CVM013.*.**	5000K	90 W	850 mA	14400 lm	12096 lm
CVM014.*.**	4000K	90 W	850 mA	13950 lm	11520 lm
CVM015.*.**	2700K	90 W	850 mA	12510 lm	10713 lm

* Opc. de Lente



** Opc. de Reg.

PH	Fotocélula ON/OFF / Fotocélula ON/OFF	D110	1-10V
TD5	Telegestión CASAMBI / Telegestão CASAMBI	DA	Dali
SR	Sin regulación / Sem regulação	DPR	Programable / Programável
DN2-	Doble nivel sin línea de mando / Duplo nível sem cabo regulador		
DN2+	Doble nivel con línea de mando / Duplo nível com cabo regulador		
DRC	Regulación en cabecera / Regulação na cabeça		

*CRI>80 bajo pedido / CRI>80 por encomenda

RUA "L"

PRO CVL

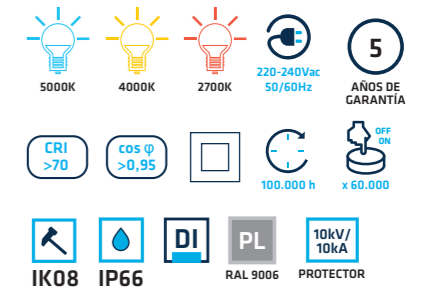

• LED

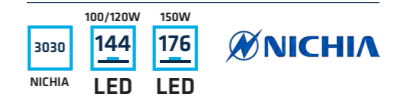

• Material



• Opc. de Reg.



• Opcional



• Certif.

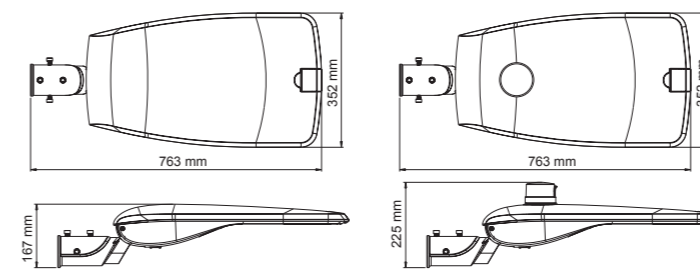

IIIII	CCT	W	I	☀	☀
CVL001.*.**	5000K	100 W	850 mA	14360 lm	12445 lm
CVL002.*.**	4000K	100 W	850 mA	15115 lm	13100 lm
CVL003.*.**	2700K	100 W	850 mA	14050 lm	12050 lm
CVL004.*.**	5000K	120 W	1050 mA	17100 lm	14820 lm
CVL005.*.**	4000K	120 W	1050 mA	18000 lm	15600 lm
CVL006.*.**	2700K	120 W	1050 mA	16560 lm	14352 lm
CVL007.*.**	5000K	150 W	1050 mA	21211 lm	18383 lm
CVL008.*.**	4000K	150 W	1050 mA	22327 lm	19350 lm
CVL009.*.**	2700K	150 W	1050 mA	20541 lm	17802 lm

* Opc. de Lente



** Opc. de Reg.

PH	Fotocélula ON/OFF / Fotocélula ON/OFF	D110	1-10V
TD5	Telegestión CASAMBI / Telegestão CASAMBI	DA	Dali
SR	Sin regulación / Sem regulação	DPR	Programable / Programável
DN2-	Doble nivel sin línea de mando / Duplo nível sem cabo regulador		
DN2+	Doble nivel con línea de mando / Duplo nível com cabo regulador		
DRC	Regulación en cabecera / Regulação na cabeça		

*CRI>80 bajo pedido / CRI>80 por encomenda

ESPACIOS / ZONAS

ELIGE LA LENTE ADECUADA A CADA SITUACIÓN / SELECIONE A LENTE ADEQUADA A CADA SITUAÇÃO

TIPO I Short

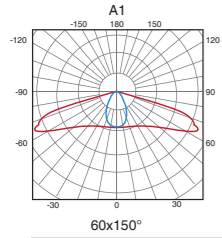

Para alturas entre $h=4\text{m}$ y $h=6\text{m}$ e interdistancias (w) entre 1h y 2,25h
Para alturas entre $h=4\text{m}$ y $h=6\text{m}$ e interdistancias entre 1h e 2,25h

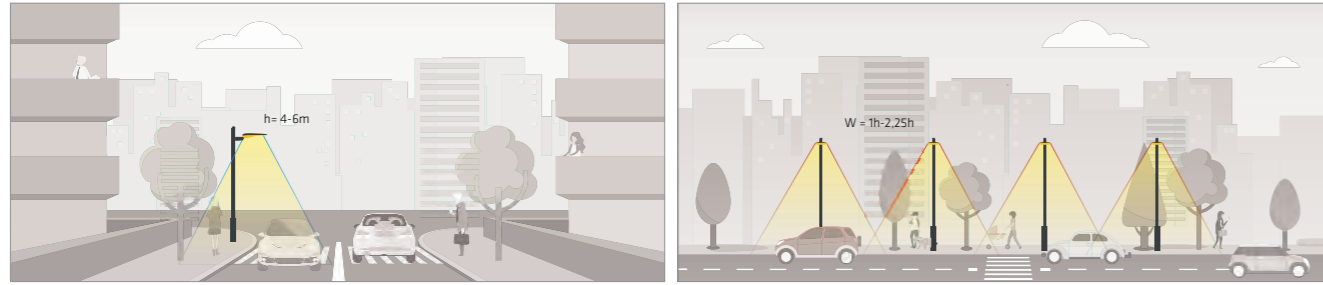

TIPO II Short

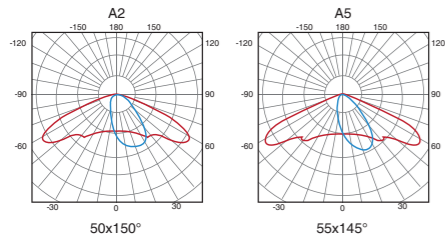

Para alturas entre $h=6\text{m}$ y $h=8\text{m}$ e interdistancias (w) entre 1h y 2,25h
Para alturas entre $h=6\text{m}$ y $h=8\text{m}$ e interdistancias entre 1h e 2,25h

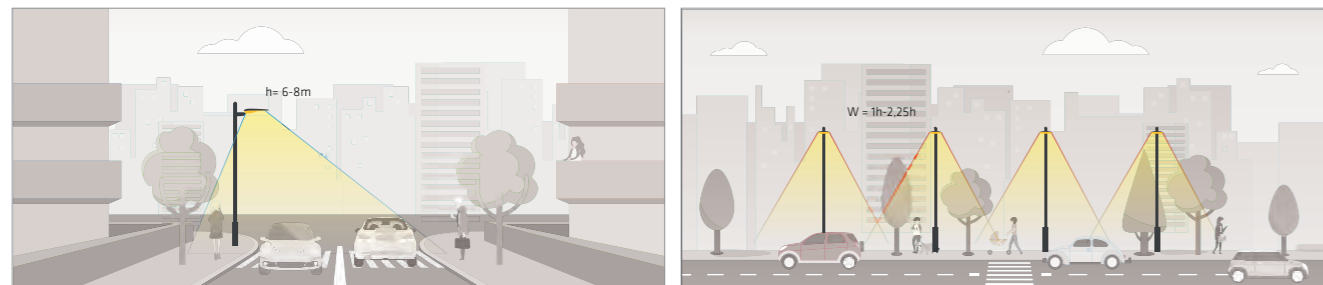

TIPO II Medium

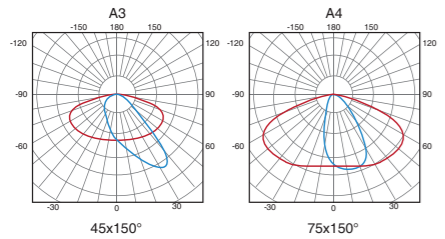

Para alturas entre $h=6\text{m}$ y $h=8\text{m}$ e interdistancias (w) entre 2,25h y 3,75h
Para alturas entre $h=6\text{m}$ y $h=8\text{m}$ e interdistancias entre 2,25h e 3,75h

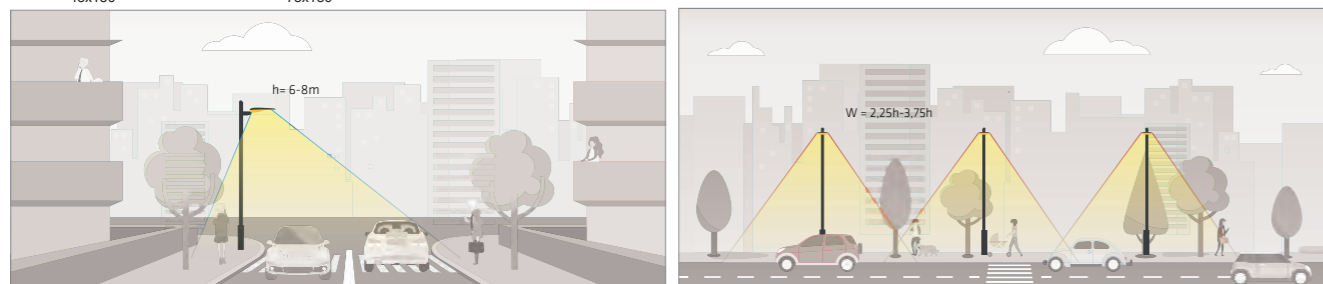

ESPACIOS / ZONAS

TIPO III Very Short

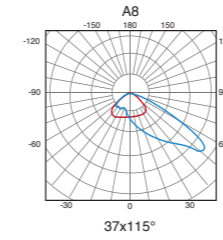

Para alturas entre $h=6\text{m}$ y $h=8\text{m}$ e interdistancias (w) entre 1h y 1,75h. Apropriada para cruces de 2 carriles.
Para alturas entre $h=6\text{m}$ y $h=8\text{m}$ e interdistancias (w) entre 1h y 1,75h. Apropriada para cruzamientos de duas vias rodoviárias.

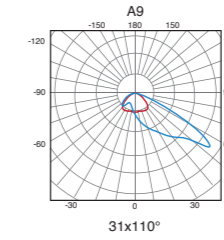

Para alturas entre $h=8\text{m}$ y $h=10\text{m}$ e interdistancias (w) entre 1h y 1,75h. Apropriada para cruces de 4 carriles.
Para alturas entre $h=8\text{m}$ y $h=10\text{m}$ e interdistancias (w) entre 1h y 1,75h. Apropriada para cruzamientos de quatro vias rodoviárias.

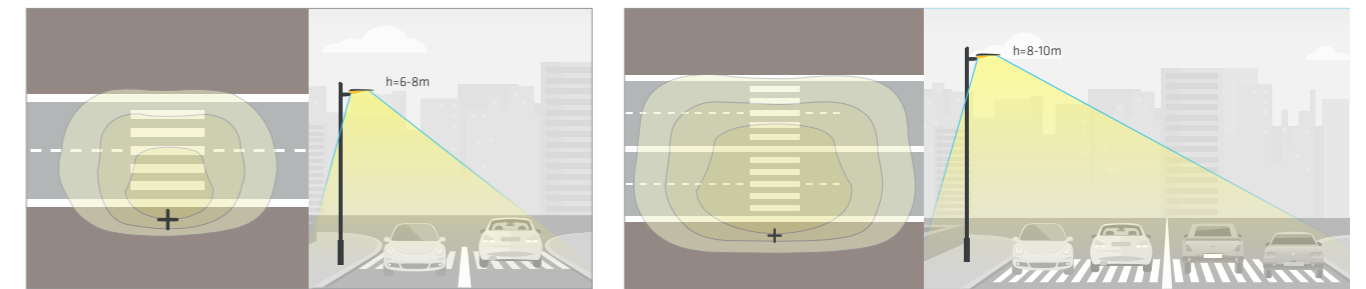

TIPO III Medium / TIPO III Medium

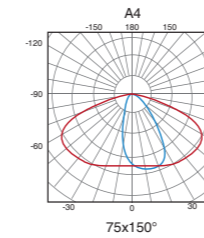

Para alturas entre $h=8\text{m}$ y $h=10\text{m}$ e interdistancias (w) entre 2,25h y 3,75h
Para alturas entre $h=8\text{m}$ y $h=10\text{m}$ e interdistancias (w) entre 2,25h e 3,75h

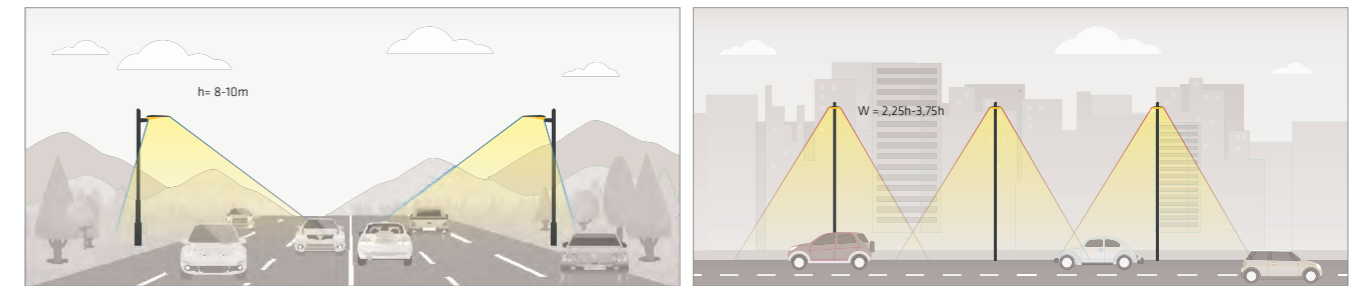

TIPO V / TIPO V

Para zonas en las cuales se necesite una distribución lumínica simétrica
Para zonas onde seja necessária uma distribuição lumínica simétrica

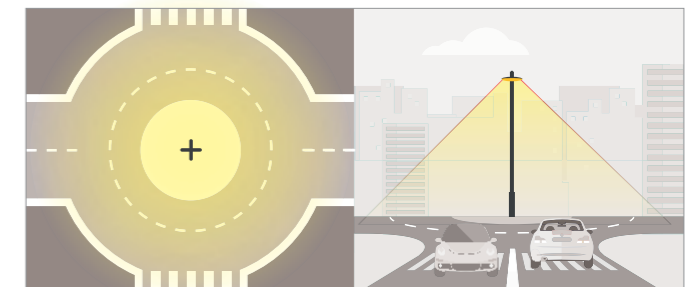
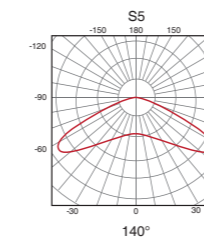

KALE S/M/L/XL

ECO KVS / KVM / KVL / KVXL

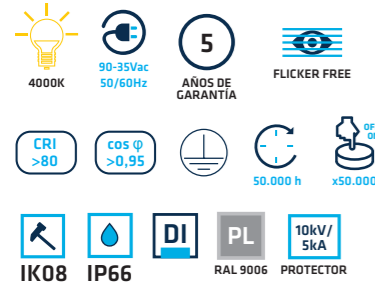

• Material



• Certif.



PROTECTOR CONTRA SOBRETENSIONES INCLUIDO
PROTECTOR CONTRA SOBRETENSÕES INCLUIDO



140lm/W reales
140lm/W reais

	A	B	C
KVS	534,7 mm	192,47 mm	82,5 mm
KVM	577 mm	222,23 mm	87,5 mm
KVL	667 mm	285,97 mm	90,5 mm
KVXL	764,5 mm	312 mm	90,5 mm

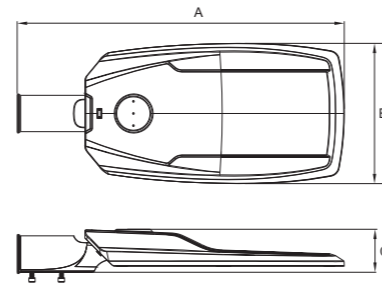

Mismo soporte para instalación en mástil (vertical) o en brazo (horizontal).

Suporte único para instalação no poste (vertical) ou no braço (horizontal).

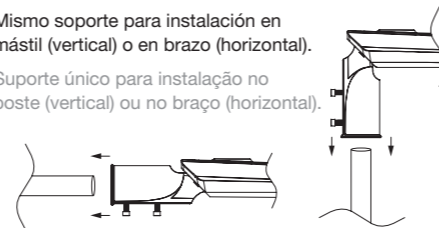

IIIIII	☹	W	CCT	☹	☹
KVS03040	*	30 W	● 4000K	4800 lm	4200 lm
KVS05040	*	50 W	● 4000K	11200 lm	7000 lm
KVM08040	*	80 W	● 4000K	12800 lm	11200 lm
KVM10040	*	100 W	● 4000K	16000 lm	14000 lm
KVL12040	*	120 W	● 4000K	19200 lm	16800 lm
KVL15040	*	150 W	● 4000K	24000 lm	21000 lm
KVXL20040	*	200 W	● 4000K	32000 lm	28000 lm
KVXL24040	*	240 W	● 4000K	38400 lm	33600 lm

* Opc. de Lente



URBAN

PRO URBANR_CV / URBANB_CV

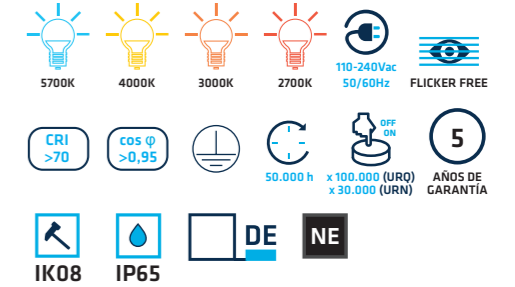

• Ángulos



• Material



• Certif.



• Opc. de Reg.

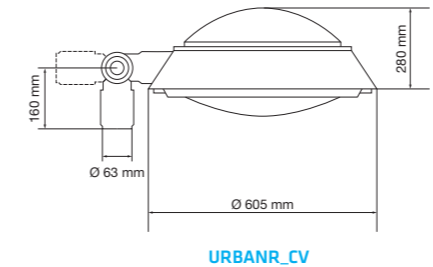
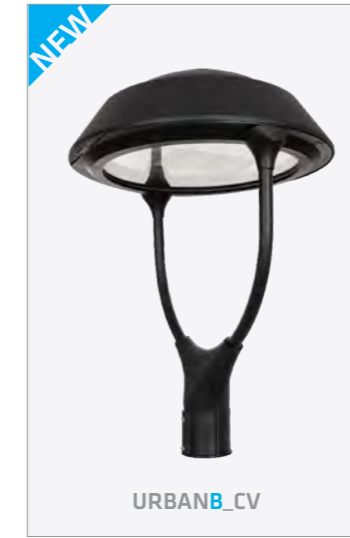
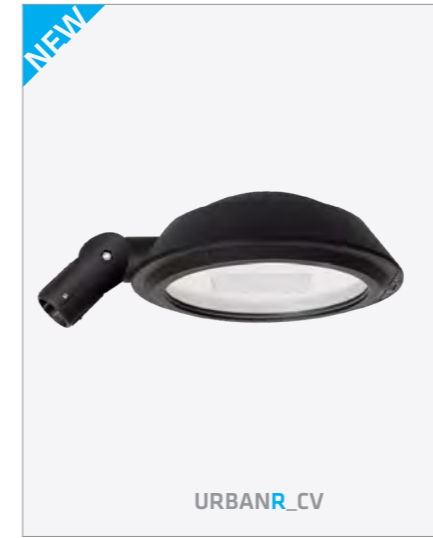

URBANR_CV

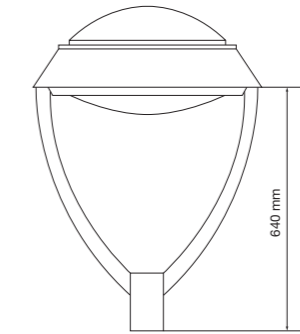

URBANB_CV

REALIZA TU PEDIDO / FAÇA SEU PEDIDO

Se deberá pedir por separado: / Deve ser pedido separadamente:

1. Ref. del chasis de la luminaria: URBANR_CV ó URBANB_CV / Ref. do chassis da luminária: URBANR_CV ou URBANB_CV
2. Ref. del módulo LED: URN ó URQ en función de las características deseadas / Módulo LED ref.: URN ou URQ dependendo das características desejadas)

Ej.: URBANR_CV (Ref. del chasis)

Ej.: URN + 100 + 27 + A6 + D7 = URN10027A6D7 (Ref. del módulo LED)

IIIIII	W	CCT	☹	☹	☹	☹	*
URN	50 W	050	● 4000K	40	80x150°	A6	Sin Regulación
	100 W	100	● 2700K	27	150°	150	1-10V D1
	150 W	150					DALI D2
	200 W	200					DN2- D6 DN2+ D7 DRC D8
URQ	40 W	040	● 5700K	57	45°	45	Sin Regulación
	80 W	080	● 4000K	40	60°	60	1-10V D1
	120 W	120	● 3000K	30	120°	120	Dali D2

* Opcional:



CCT	40 W		50 W		80 W		100 W		120 W		150 W		200 W	
● 5700K	8000 lm	6800 lm	-	-	16000 lm	13600 lm	-	-	24000 lm	20400 lm	-	-	-	-
● 4000K	7840 lm	6664 lm	8350 lm	7700 lm	15680 lm	13328 lm	16700 lm	15400 lm	23520 lm	19992 lm	25050 lm	23100 lm	33400 lm	30800 lm
● 3000K	7600 lm	6460 lm	-	-	15200 lm	12920 lm	-	-	22800 lm	19380 lm	-	-	-	-
● 2700K	-	-	6750 lm	6500 lm	-	-	13500 lm	13000 lm	-	-	2050 lm	19500 lm	27000 lm	26000 lm

VILLA

PRO VILLA_CV

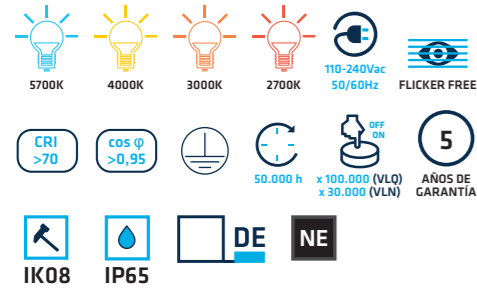

• Ángulos



• Material



• Certif.



• Opc. de Reg.

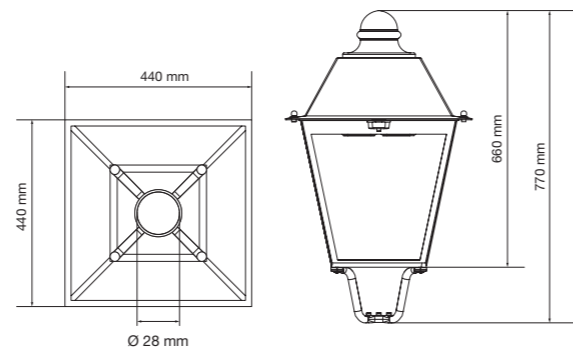

REALIZA TU PEDIDO / FAÇA SEU PEDIDO

Se deberá pedir por separado: / Deve ser pedido separadamente:

1. Ref. del chasis de la luminaria: [VILLA_CV](#) / Ref. do chassis da luminária: [VILLA_CV](#)
2. Ref. del módulo LED: [VLN](#) ó [VLQ](#) en función de las características deseadas / Módulo LED ref.: [VLN](#) ou [VLQ](#) dependendo das características deseadas

Ej.: [VILLA_CV](#) (Ref. del chasis)

Ej.: [VLQ](#) + 040 + 40 + 120 + D2 = [VLQ04040120D2](#) (Ref. del módulo LED)

IIIIII	W	CCT	⤴	⤵	*		
	25 W	025	● 4000K	40	80x150°	A6	Sin Regulación
	50 W	050	● 2700K	27	150°	150	1-10V D1
	100 W	100					DALI D2
							DN2- D6
							DN2+ D7
							DRC D8
	40 W	040	● 5700K	57	45°	45	Sin Regulación
	80 W	080	● 4000K	40	60°	60	1-10V D1
			● 3000K	30	120°	120	Dali D2

* Opcional:



CCT	25 W		40 W		50 W		80 W		100 W	
● 5700K	-	-	8000 lm	6800 lm	-	-	16000 lm	13600 lm	-	-
● 4000K	4175 lm	3850 lm	7840 lm	6664 lm	8350 lm	7700 lm	15680 lm	13328 lm	16700 lm	15400 lm
● 3000K	-	-	7600 lm	6460 lm	-	-	15200 lm	12920 lm	-	-
● 2700K	3375 lm	3250 lm	-	-	6750 lm	6500 lm	-	-	13500 lm	13000 lm

FERNANDINA

PRO FERNANDINA_CV

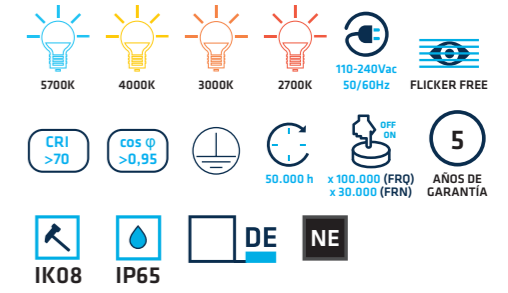

• Ángulos



• Material



• Certif.



• Opc. de Reg.

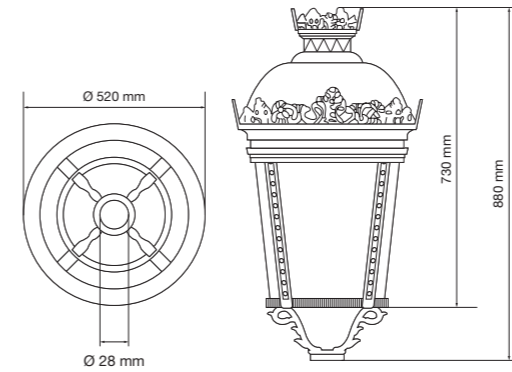

REALIZA TU PEDIDO / FAÇA SEU PEDIDO

Se deberá pedir por separado: / Deve ser pedido separadamente:

1. Ref. del chasis de la luminaria: [FERNANDINA_CV](#) / Ref. do chassis da luminária: [FERNANDINA_CV](#)
2. Ref. del módulo LED: [FRN](#) ó [FRQ](#) en función de las características deseadas / Módulo LED ref.: [FRN](#) ou [FRQ](#) dependendo das características deseadas

Ej.: [FERNANDINA_CV](#) (Ref. del chasis)

Ej.: [FRQ](#) + 080 + 40 + 120 + D1 = [FRQ08040120D1](#) (Ref. del módulo LED)

IIIIII	W	CCT	⤴	⤵	*		
	25 W	025	● 4000K	40	80x150°	A6	Sin Regulación
	50 W	050	● 2700K	27	150°	150	1-10V D1
	100 W	100					DALI D2
							DN2- D6
							DN2+ D7
							DRC D8
	40 W	040	● 5700K	57	45°	45	Sin Regulación
	80 W	080	● 4000K	40	60°	60	1-10V D1
			● 3000K	30	120°	120	Dali D2

* Opcional:



CCT	25 W		40 W		50 W		80 W		100 W	
● 5700K	-	-	8000 lm	6800 lm	-	-	16000 lm	13600 lm	-	-
● 4000K	4175 lm	3850 lm	7840 lm	6664 lm	8350 lm	7700 lm	15680 lm	13328 lm	16700 lm	15400 lm
● 3000K	-	-	7600 lm	6460 lm	-	-	15200 lm	12920 lm	-	-
● 2700K	3375 lm	3250 lm	-	-	6750 lm	6500 lm	-	-	13500 lm	13000 lm



Tecnología convencional

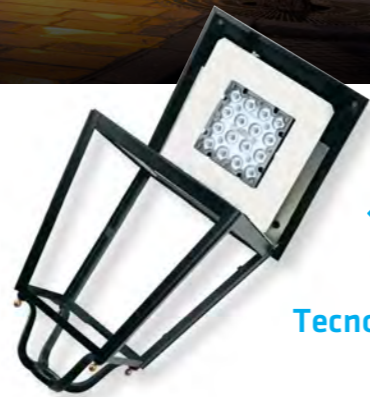

Tecnología LED

Threeline ofrece un **SERVICIO PERSONALIZADO** para la adaptación del módulo LED a la farola ya instalada.

1. Envíanos a fábrica una **muestra de la chapa** o las **medidas** para que realicemos la adaptación.
2. Nuestro Dpto. Técnico de I+D realizará el **diseño de la chapa** y el **estudio de las luminarias** necesarias.
3. Una vez realizado el diseño de la adaptación se pasa a la fase de **fabricación**.
4. Ya fabricada, se realizarán distintas **pruebas** y comprobaciones de los parámetros para la **verificación del diseño y la calidad**.
5. Posteriormente pasará por el Dpto. de Producción para realizar el **ensamblaje entre la placa y la luminaria**.
6. Una vez finalizado, desde nuestro Dpto. de Logística será **enviado el pedido**.

A Threeline oferece um **SERVIÇO PERSONALIZADO** para a adaptação do módulo LED à iluminação pública já instalada.

1. Envie-nos uma **amostra da chapa**, ou as **medidas** do equipamento já instalado, para que a fábrica possa fazer a adaptação.
2. O nosso Departamento Técnico de P&D irá **projetar a chapa** e **analisar as luminárias** necessárias.
3. Uma vez feito o desenho de adaptação, passaremos à fase de **fabrico**.
4. Depois de fabricados, serão realizados vários **testes** e verificações de parâmetros para **analisar o design e a qualidade**.
5. Posteriormente, passará para o Departamento de Produção, que irá efetuar a **montagem entre a placa e a luminária**.
6. Depois de concluído todo o processo, o **pedido será enviado** pelo nosso Departamento de Logística.

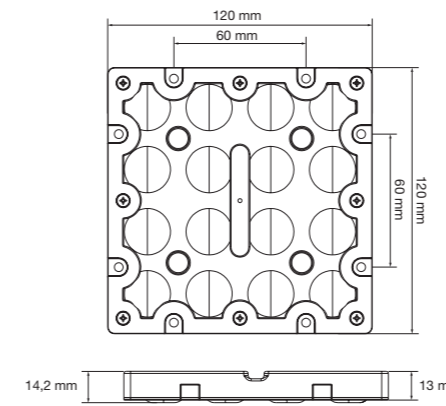

150lm/W reales
150lm/W reais

NUIT

PRO NUI

- 4000K
- 2700K
- 110-240Vac 50/60Hz
- 5 AÑOS DE GARANTÍA
- FLICKER FREE
- CRI >70
- cos φ >0,95
- 50.000 h
- x30.000
- IP65
- DE
- NE RAL 9003

• Material

AL PC
CUERPO DIFUSOR

• Ángulos



• Certif.



*Genera tu referencia / Gere a sua referência

NUIT	W	CRI	CCT	Beam	Mount	Optical	Protection
NUIT	20 W	20	CRI>70	7	● 2700K 27	80X150	A6 SR
	30 W	30			● 4000K 40	150	S6 DN2- DN2-
	40 W	40					DN2+ DN2+
	50 W	50					D110 D110
							DA DA
							DPR DPR

* Opcional:



W	CCT	Beam	Beam
20 W	● 4000K	3340 lm	3000 lm
	● 2700K	3140 lm	2900 lm

W	CCT	Beam	Beam
30 W	● 4000K	5010 lm	4350 lm
	● 2700K	4620 lm	4200 lm

W	CCT	Beam	Beam
40 W	● 4000K	6680 lm	5600 lm
	● 2700K	6160 lm	5400 lm

W	CCT	Beam	Beam
50 W	● 4000K	8350 lm	7700 lm
	● 2700K	6750 lm	6500 lm

Las referencias de nuestro grupo óptico NUIT incluyen el módulo LED, el driver y la chapa.

As referências do nosso grupo óptico NUIT incluem o módulo LED, o driver e a chapa.



Tracklight Tracklight



Perfiles Perfis

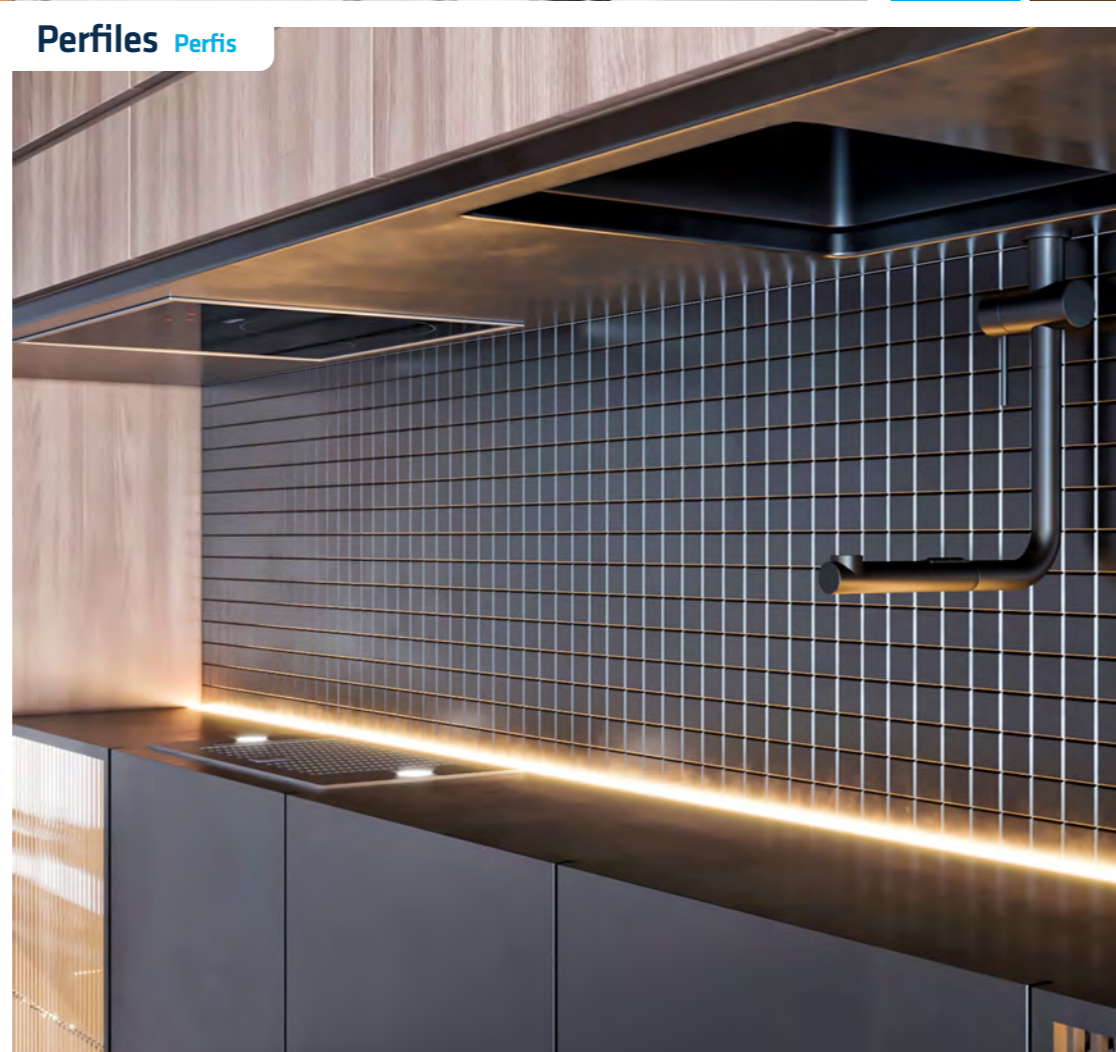

Tiras LED Fitas LED



DECORATIVA

Tracklight Tracklight



TRACKLIGHT
TRACKLIGHT

TIRAS LED
FITAS LED

PERFILES
PERFIS

PRO **APOLO**

9W 18W 30W



THREELINE
Small



PRO **HERMES** NEW



30W 35W 40W



NEW **ARES**

CCT SWITCH 14W 20W 21W 30W
POWER SWITCH POWER SWITCH



Ventosa
incluida

PRO **METIS**

CARRIL

BL NE



APOLO

PREMIUM CRPOL / EMPOL / SPPOL

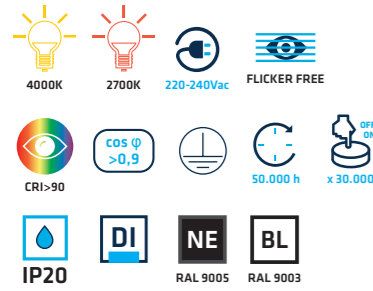

• Material



• Opc. de Reg.



• Certif.



• Ángulos

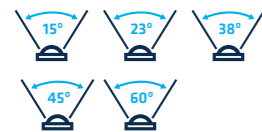

Posibilidad de aro dorado
Possibilidade de aro dourado



APOLO

9 W / 18 W / 30 W PREMIUM

(CR) TRACKLIGHT

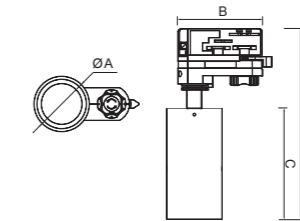

	CRPOL 9W	CRPOL 18W	CRPOL 30W
A	Ø 55 mm	Ø 63 mm	Ø 75 mm
B	94,9 mm	98,9 mm	104,9 mm
C	79,2 mm	145 mm	165 mm
D	189,2 mm	224,2 mm	244,2 mm

(EM) EMPOTRAR / ENCASTRAR

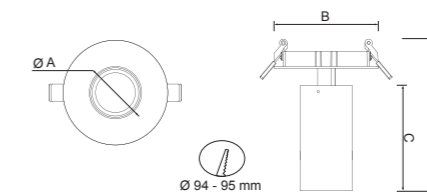

	EMPOL 9W	EMPOL 18W	EMPOL 30W
A	Ø 55 mm	Ø 63 mm	Ø 75 mm
B	110 mm	110 mm	110 mm
C	110 mm	145 mm	165 mm
D	159 mm	194 mm	214 mm

(SP) SUPERFICIE / SUPERFÍCIE

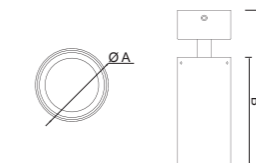

	SPPOL 9W	SPPOL 18W	SPPOL 30W
A	Ø 55 mm	Ø 63 mm	Ø 75 mm
B	110 mm	145 mm	165 mm
C	158,5 mm	198,5 mm	223,5 mm

*Genera tu referencia / Gere a sua referência

	W	CRI	CCT	Beam	ARO	OPCIONAL
CR	POL (Apolo)	09	9 W	9 >90	4 ● 4000K 15 15°	B □ B □
EM	18	18 W	3K	● 3000K 23 23°	N ■ N ■	
SP	30	30 W	3	● 2700K 38 38°	D ■	
				45 45°		
				60 60°		

W	CCT	Beam	Beam	W	CCT	Beam	Beam	W	CCT	Beam	Beam
9 W	● 4000K	1080 lm	909 lm	18 W	● 4000K	2160 lm	1818 lm	30 W	● 4000K	3600 lm	3030 lm
	● 3000K	1071 lm	873 lm		● 3000K	2142 lm	1746 lm		● 3000K	3570 lm	2910 lm
	● 2700K	1062 lm	855 lm		● 2700K	2124 lm	1710 lm		● 2700K	3540 lm	2850 lm

NEW
HERMES

PRO CRH3040C9CCT



• Certif.



Selector de potencia
Seleto de potência

Selector CCT
Seleto CCT

Reflector en policarbonato
Refleto em policarbonato

Cuerpo de aluminio
Corpo em aluminio

Chip LED COB
Chip LED COB

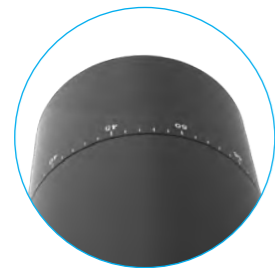

Ángulo ajustable 24°~60°
Ângulo variável 24°~60°



0°~90°

HERMES

PRO CRH3040C9CCT

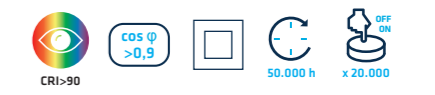
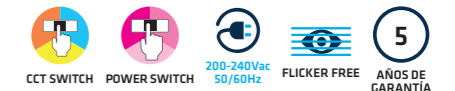

• Material



• Certif.

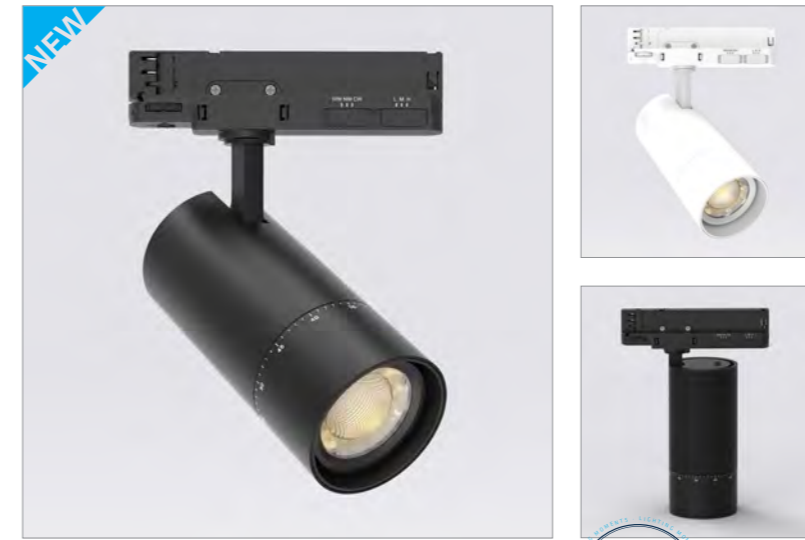

ANGULO VARIABLE
ÂNGULO VARIÁVEL

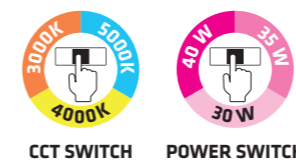
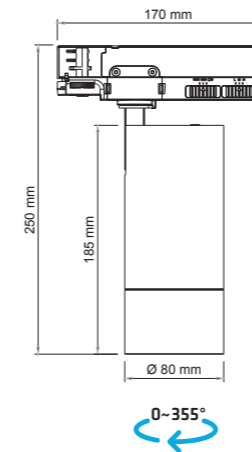

	W	CCT	lm	lm
CRH3040C9CCT	30 W	5000K	3600 lm	3000 lm
		4000K	3600 lm	3000 lm
		3000K	3450 lm	2850 lm
CRH3040C9CCT	35 W	5000K	4200 lm	3500 lm
		4000K	4200 lm	3500 lm
		3000K	4025 lm	3325 lm
CRH3040C9CCT	40 W	5000K	4800 lm	4000 lm
		4000K	4800 lm	4000 lm
		3000K	4600 lm	3800 lm

Añadir detrás de la referencia un 0 para acabado blanco ó un 2 para acabado negro.
Adicione um 0 após a referência para um acabamento branco ou um 2 para um acabamento preto.

ARES

ECO CRA1420CCT

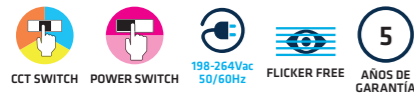

• Material



• Certif.

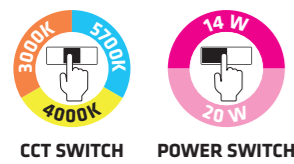
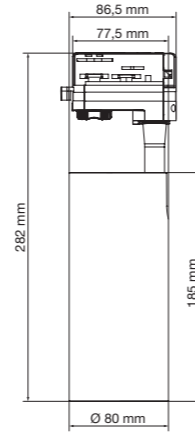

Model	Color	Beam Angle	W	CCT	15°	30°
CRA1420CCT45	0 □	45°	14 W	5700K	1580 lm	1300 lm
				4000K	1580 lm	1300 lm
	3000K			1455 lm	1180 lm	
	2 ■		5700K	2170 lm	1770 lm	
			4000K	2170 lm	1770 lm	
			3000K	1960 lm	1560 lm	
CRA1420CCT60	0 □	60°	14 W	5700K	1580 lm	1300 lm
				4000K	1580 lm	1300 lm
	3000K			1455 lm	1180 lm	
	2 ■		5700K	2170 lm	1770 lm	
			4000K	2170 lm	1770 lm	
			3000K	1960 lm	1560 lm	

Añadir detrás de la referencia un 0 para acabado blanco ó un 2 para acabado negro.
Adicione um 0 após a referência para um acabamentoo branco ou um 2 para um acabamentoo preto.

ARES

ECO CRA2130CCT

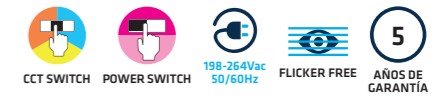

• Material



• Certif.

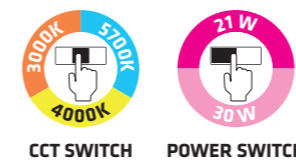
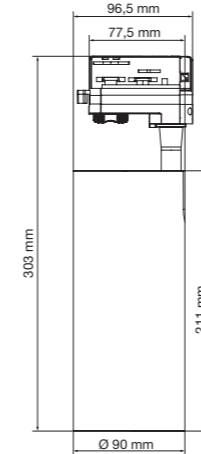

Model	Color	Beam Angle	W	CCT	15°	30°
CRA2130CCT45	0 □	45°	21 W	5700K	2350 lm	1950 lm
				4000K	2350 lm	1950 lm
	3000K			2190 lm	1770 lm	
	2 ■		5700K	3180 lm	2570 lm	
			4000K	3180 lm	2570 lm	
			3000K	2940 lm	2350 lm	
CRA2130CCT60	0 □	60°	21 W	5700K	2350 lm	1950 lm
				4000K	2350 lm	1950 lm
	3000K			2190 lm	1770 lm	
	2 ■		5700K	3180 lm	2570 lm	
			4000K	3180 lm	2570 lm	
			3000K	2940 lm	2350 lm	

Añadir detrás de la referencia un 0 para acabado blanco ó un 2 para acabado negro.
Adicione um 0 após a referência para um acabamentoo branco ou um 2 para um acabamentoo preto.

METIS



• Material



VENTOSA INCLUIDA*
VENTOSA INCLUÍDA*

*Necesaria para la colocación y el cambio de la lámpara.
*Necessária para a colocação e troca de lâmpada.



METIS TRACKLIGHT

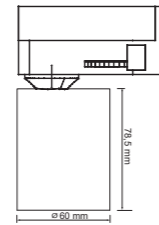

METIS SUPERFICIE 1 UD.

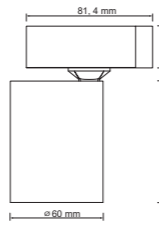

METIS SUPERFICIE 2 UDS.

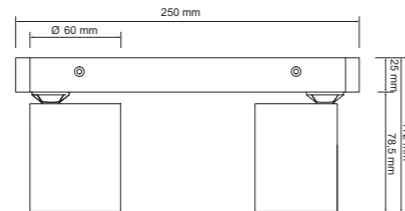

METIS SUPERFICIE 3 UDS.

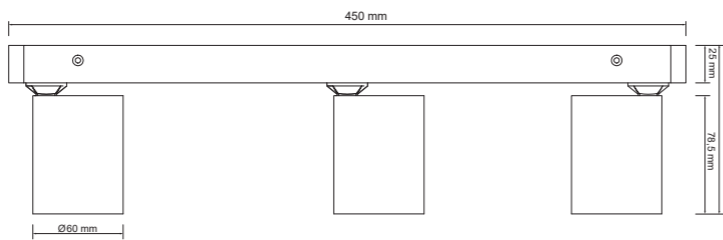

METIS SUPERFICIE 4 UDS.

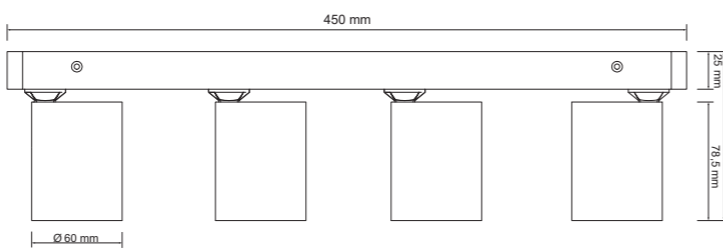

TRACKLIGHT ACCESORIOS / ACESSÓRIOS

CARRIL / CALHA

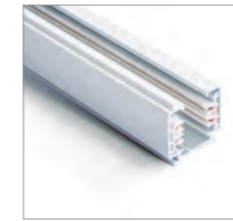

BL ACRBL
NE ACRNE

Carril Electrificado 2 metros.
Calha de 2 metros eletrificada.

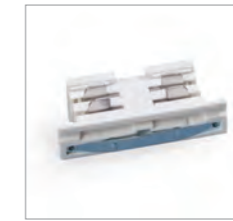

BL ACRUBL
NE ACRUNE

Junta unión interior carril.
União interior calha.



BL ACRDBL
NE ACRDNE

Alimentador eléctrico lateral derecho.
Alimentador elétrico lateral direito.



BL ACRJBL
NE ACRJNE

Junta flexible carril.
União flexível calha.



BL ACRI BL
NE ACRI NE

Alimentador eléctrico lateral izquierdo.
Alimentador elétrico lateral esquerdo.



BL ACRTDBL
NE ACRTDNE

Junta en T derecha para carril.
União em T direita para calha.

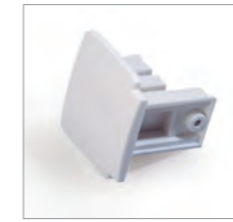

BL ACRFBL
NE ACRFNE

Tapa final carril.
Topo final calha.

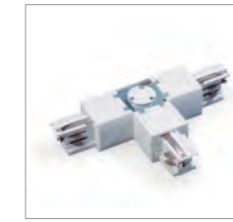

BL ACRTIBL
NE ACRTINE

Junta en T izquierda para carril.
União em T esquerda para calha.



BL ACRSBL
NE ACRSNE

Kit suspensión carril. (1 ud.)
1,5 m de cable.
Kit suspensão calha. (1 un.)
Cabo de 1,5 m.



BL ACRXBL
NE ACRXNE

Junta en X para carril.
União em X para calha.

SUPERFICIE / SUPERFÍCIE



BL AST110BL
NE AST110NE

Accesorio de superficie para tracklight.
Acessório de superfície para tracklight.

3 fases - 3 encendidos
3 fases - 3 acesos



Iluminación Decorativa / Iluminação Decorativa

Tiras LED Fitas LED



TRACKLIGHT
TRACKLIGHT

TIRAS LED
FITAS LED

PERFILES
PERFIS



Vin

24Vdc

230Vac

MONOCOLOR

RGB

DIGITAL

BICOLOR

LATERAL

--	--	--	--	--	--	--	--	--	--	--	--	--	--	--	--	--	--	--	--	--	--	--	--	--	--	--	--	--	--	--	--	--	--	--	--	--	--	--	--	--	--	--	--	--	--	--	--	--	--

REF



CCT



IP



W/m



LED/m



lm/W

REF	CCT	IP	W/m	LED/m	lm/W
TRAKA T3528300		IP20 / IP67	4,8	60	75
TRAKA T3528600		IP20 / IP67	9,6	120	75
TRAKA T5050150		IP20 / IP67	7,2	30	83
TRAKA T5050300		IP20 / IP67	14,4	60	83
MANA XM2835060		IP20 / IP65	4,8	60	125
MANA XM2835120		IP20 / IP65 / IP68	9,6	120	104
MANA XM5050060		IP20 / IP65 / IP68	10	60	90
TRAKA T2835490		IP20 / IP67	10	99	100
TRAKA T5630300		IP20 / IP67	14,4	60	125
HALEN XH2835060		IP20 / IP65	14,4	60	150
HALEN XH2835120		IP20 / IP65	19,2	120	150
HALEN XH2835240		IP20	19,2	240	150
PRIEST XP2835240		IP20	19,2	240	150
NAS XN2110060		IP20	14,4	60	150
SUEDE XS2835120		IP20	9,6	120	104
TRAKA T5050300RGB		IP20 / IP67	14,4	60	-
TRAKA T5050300RGB+W		IP20 / IP67	19,2	60	-
XUA XX5050060RG		IP20 / IP65 / IP68	10	60	-
XUA XX5050060RW		IP20 / IP65	10	60	-
DUNCAN XD5050060P65RG		IP65	14,4	60	-
DUNCAN XD5050060P65RW		IP65	19,2	60	-
TRAKA T3527300BI		IP20 / IP67	9,6	60	81
TRAKA T2835560BI		IP20 / IP67	19,2	112	128
TRAKA T3528600BI		IP20 / IP67	9,6	120	75
BLONDIE XB3527060		IP20 / IP65	9,6	60	81
BLONDIE XB2835112		IP20 / IP65	19,2	112	128
BLONDIE XB3528120		IP20 / IP65	9,6	120	75
TRAKA T3014600		IP20 / IP67	12	120	100
LIZ XL3014120		IP20 / IP65	12	120	100
ABBA XA2835075		IP65	7	75	128

DECORATIVA / DECORATIVA

TRAKA

PRO+ T3528300 Monocolor / Monocor



6000K 4000K 2700K 24Vdc

IP20 IP67 OPCIONAL Págs. 232-233

CRI >80 50.000 h x 30.000

Model	CCT	IP	Beam (1m)	Beam (1m)
T3528300IP2024VBF	6000K	IP20	432 lm	360 lm
T3528300IP2024VBN	4000K	IP20	422 lm	322 lm
T3528300IP2024VBC	2700K	IP20	408 lm	298 lm
T3528300IP6724VBF	6000K	IP67	432 lm	360 lm
T3528300IP6724VBN	4000K	IP67	422 lm	322 lm
T3528300IP6724VBC	2700K	IP67	408 lm	298 lm

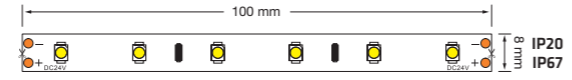

4,8W/m LED 3528 60 LED/m 100 mm

• Accesorios



TRAKA

PRO+ T3528600 Monocolor / Monocor

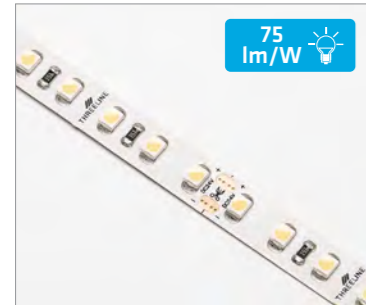

6000K 4000K 2700K 24Vdc

IP20 IP67 OPCIONAL Págs. 232-233

CRI >80 50.000 h x 30.000

Model	CCT	IP	Beam (1m)	Beam (1m)
T3528600IP2024VBF	6000K	IP20	864 lm	720 lm
T3528600IP2024VBN	4000K	IP20	844 lm	690 lm
T3528600IP2024VBC	2700K	IP20	816 lm	631 lm
T3528600IP6724VBF	6000K	IP67	864 lm	720 lm
T3528600IP6724VBN	4000K	IP67	844 lm	690 lm
T3528600IP6724VBC	2700K	IP67	816 lm	631 lm

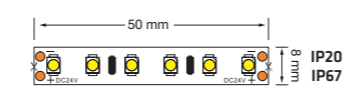

9,6W/m LED 3528 120 LED/m 50 mm

• Accesorios



TRAKA

PRO+ T5050150 Monocolor / Monocor



6000K 4000K 2700K 24Vdc

IP20 IP67 OPCIONAL Págs. 232-233

CRI >80 50.000 h x 30.000

Model	CCT	IP	Beam (1m)	Beam (1m)
T5050150IP2024VBF	6000K	IP20	705 lm	600 lm
T5050150IP2024VBN	4000K	IP20	691 lm	570 lm
T5050150IP2024VBC	2700K	IP20	677 lm	510 lm
T5050150IP6724VBF	6000K	IP67	705 lm	600 lm
T5050150IP6724VBN	4000K	IP67	691 lm	570 lm
T5050150IP6724VBC	2700K	IP67	677 lm	510 lm

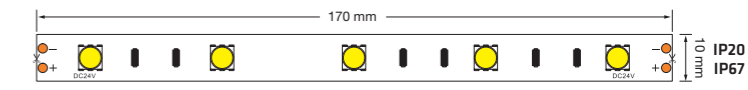

7,2W/m LED 5050 30 LED/m 170 mm

• Accesorios



TRAKA

PRO+ T5050300 Monocolor / Monocor



6000K 4000K 2700K 24Vdc

IP20 IP67 OPCIONAL Págs. 232-233

CRI >80 50.000 h x 30.000

Model	CCT	IP	Beam (1m)	Beam (1m)
T5050300IP2024VBF	6000K	IP20	1411 lm	1200 lm
T5050300IP2024VBN	4000K	IP20	1382 lm	1140 lm
T5050300IP2024VBC	2700K	IP20	1354 lm	1020 lm
T5050300IP6724VBF	6000K	IP67	1411 lm	1200 lm
T5050300IP6724VBN	4000K	IP67	1382 lm	1140 lm
T5050300IP6724VBC	2700K	IP67	1354 lm	1020 lm

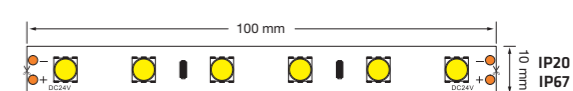

14,4W/m LED 5050 60 LED/m 100 mm

• Accesorios



MANA

PRO XM2835060 Monocolor / Monocor

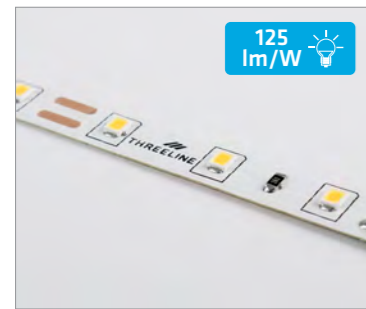

6000K 4000K 3000K 24Vdc

IP20 IP65 OPCIONAL Págs. 232-233

CRI >80 30.000 h x 15.000

Modelo	CCT	IP	1 (1m)	2 (1m)
XM2835060P2060	6000K	IP20	695 lm	600 lm
XM2835060P2040	4000K	IP20	695 lm	600 lm
XM2835060P2030	3000K	IP20	681 lm	585 lm
XM2835060P6560	6000K	IP65	695 lm	600 lm
XM2835060P6540	4000K	IP65	695 lm	600 lm
XM2835060P6530	3000K	IP65	681 lm	585 lm

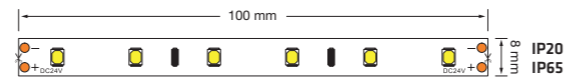

4,8W/m LED 2835 60 LED/m 100 mm

• Accesorios



Personalización
Corte a medida



MANA

PRO XM2835120 Monocolor / Monocor



6000K 4000K 3000K 2200K 24Vdc

IP20 IP65 IP68 OPCIONAL Págs. 232-233

CRI >80 30.000 h x 15.000

Modelo	CCT	IP	1 (1m)	2 (1m)
XM2835120P2060	6000K	IP20	1190 lm	1000 lm
XM2835120P2040	4000K	IP20	1190 lm	1000 lm
XM2835120P2030	3000K	IP20	1180 lm	990 lm
XM2835120P2022	2200K	IP20	1152 lm	960 lm
XM2835120P6560	6000K	IP65	1190 lm	1000 lm
XM2835120P6540	4000K	IP65	1190 lm	1000 lm
XM2835120P6530	3000K	IP65	1180 lm	990 lm
XM2835120P6860	6000K	IP68*	1190 lm	1000 lm
XM2835120P6840	4000K	IP68*	1190 lm	1000 lm
XM2835120P6830	3000K	IP68*	1180 lm	990 lm

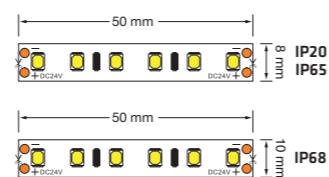

9,6W/m LED 2835 120 LED/m 50 mm

• Accesorios



Personalización
Corte a medida



MANA

PRO XM5050060 Monocolor / Monocor

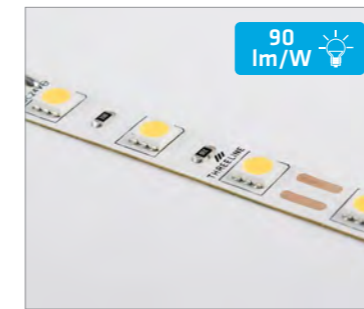

6000K 4000K 3000K 24Vdc

IP20 IP65 IP68 OPCIONAL Págs. 232-233

CRI >80 30.000 h x 15.000

Modelo	CCT	IP	1 (1m)	2 (1m)
XM5050060P2060	6000K	IP20	1100 lm	900 lm
XM5050060P2040	4000K	IP20	1100 lm	900 lm
XM5050060P2030	3000K	IP20	1070 lm	870 lm
XM5050060P6560	6000K	IP65	1100 lm	900 lm
XM5050060P6540	4000K	IP65	1100 lm	900 lm
XM5050060P6530	3000K	IP65	1070 lm	870 lm
XM5050060P6860	6000K	IP68*	1100 lm	900 lm
XM5050060P6840	4000K	IP68*	1100 lm	900 lm
XM5050060P6830	3000K	IP68*	1070 lm	870 lm

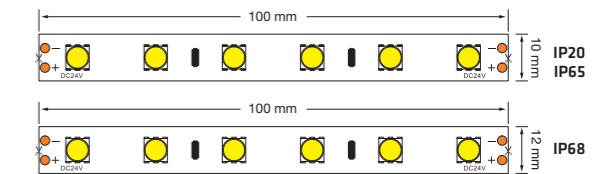

10W/m LED 5050 60 LED/m 100 mm

• Accesorios



*Las tiras IP68 se sirven en rollos de 5 m / *As fitas IP68 são vendidas em rolos de 5m

*Las tiras IP68 se sirven en rollos de 5 m / *As fitas IP68 são vendidas em rolos de 5m

TRAKA

T2835490 Monocolor alta eficiencia / Monocor alta eficiência



6000K 4000K 2700K 24Vdc

IP20 IP67 OPCIONAL Págs. 232-233

CRI >80 50.000 h x 30.000

	CCT	IP	(1 m)	(1 m)
T2835490IP2024VBF	6000K	IP20	1100 lm	1000 lm
T2835490IP2024VBN	4000K	IP20	1050 lm	950 lm
T2835490IP2024VBC	2700K	IP20	1000 lm	900 lm
T2835490IP6724VBF	6000K	IP67	1100 lm	1000 lm
T2835490IP6724VBN	4000K	IP67	1050 lm	950 lm
T2835490IP6724VBC	2700K	IP67	1000 lm	900 lm

10W/m LED 99 LED/m 71 mm

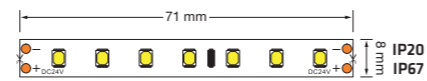

• Accesorios



Personalización
Corte a medida



TRAKA

T5630300 Monocolor alta eficiencia / Monocor alta eficiência



6000K 4000K 2700K 24Vdc

IP20 IP67 OPCIONAL Págs. 232-233

CRI >80 50.000 h x 30.000

	CCT	IP	(1 m)	(1 m)
T5630300IP2024VBF	6000K	IP20	1944 lm	1800 lm
T5630300IP2024VBN	4000K	IP20	1915 lm	1740 lm
T5630300IP2024VBC	2700K	IP20	1872 lm	1620 lm
T5630300IP6724VBF	6000K	IP67	1944 lm	1800 lm
T5630300IP6724VBN	4000K	IP67	1915 lm	1740 lm
T5630300IP6724VBC	2700K	IP67	1872 lm	1620 lm

14,4W/m LED 5630 LED/m 60 LED/m 100 mm

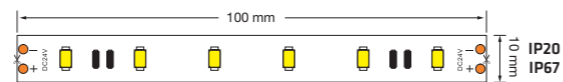

• Accesorios



HALEN

XH2835060 Monocolor alta eficiencia / Monocor alta eficiência

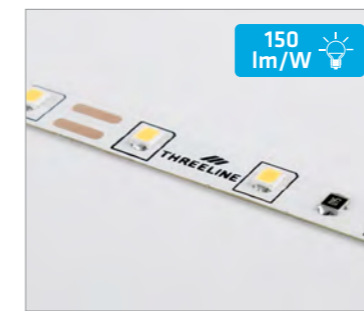

6000K 4000K 3000K 2700K

24Vdc IP20 IP65 OPCIONAL Págs. 232-233

CRI >80 30.000 h x 15.000

	CCT	IP	(1 m)	(1 m)
XH2835060P2060	6000K	IP20	2450 lm	2160 lm
XH2835060P2040	4000K	IP20	2450 lm	2160 lm
XH2835060P2030	3000K	IP20	2400 lm	2115 lm
XH2835060P2027	2700K	IP20	2400 lm	2115 lm
XH2835060P6560	6000K	IP65	2450 lm	2160 lm
XH2835060P6540	4000K	IP65	2450 lm	2160 lm
XH2835060P6530	3000K	IP65	2400 lm	2115 lm
XH2835060P6527	2700K	IP65	2400 lm	2115 lm

14,4W/m LED 2835 LED/m 60 LED/m 100 mm

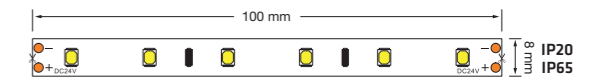

• Accesorios



Personalización
Corte a medida



HALEN

XH2835120 Monocolor alta eficiencia / Monocor alta eficiência



6000K 4000K 3000K 24Vdc

IP20 IP65 OPCIONAL Págs. 232-233

CRI >80 30.000 h x 15.000

	CCT	IP	(1 m)	(1 m)
XH2835120P2060	6000K	IP20	3265 lm	2880 lm
XH2835120P2040	4000K	IP20	3265 lm	2880 lm
XH2835120P2030	3000K	IP20	3205 lm	2820 lm
XH2835120P6560	6000K	IP65	3265 lm	2880 lm
XH2835120P6540	4000K	IP65	3265 lm	2880 lm
XH2835120P6530	3000K	IP65	3205 lm	2820 lm

19,2W/m LED 2835 LED/m 120 LED/m 50 mm

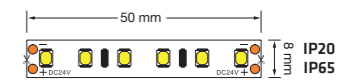

• Accesorios



HALEN

PRO XH2835240 Monocolor alta eficiencia / Monocolor alta eficiência



6000K 4000K 3000K 2700K

24Vdc IP20 OPCIONAL Págs. 232-233

CRI >80 30.000 h x 15.000

	CCT	IP	(1 m)	(1 m)
XH2835240P2060	6000K	IP20	3265 lm	2880 lm
XH2835240P2040	4000K	IP20	3265 lm	2880 lm
XH2835240P2030	3000K	IP20	3205 lm	2820 lm
XH2835240P2027	2700K	IP20	3205 lm	2820 lm

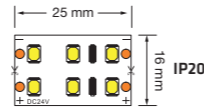

19,2W/m LED 2835 240 LED/m 25 mm

Personalización
Corte a medida



PRIEST

PRO XP2835240 Alta densidad / Alta densidade



6000K 4000K 3000K 2700K

24Vdc IP20 OPCIONAL Págs. 232-233

CRI >80 30.000 h x 15.000

	CCT	IP	(1 m)	(1 m)
XP2835240P2060	6000K	IP20	3265 lm	2880 lm
XP2835240P2040	4000K	IP20	3265 lm	2880 lm
XP2835240P2030	3000K	IP20	3205 lm	2820 lm
XP2835240P2027	2700K	IP20	3205 lm	2820 lm

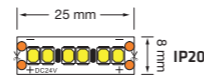

19,2W/m LED 2835 240 LED/m 25 mm

• Accesorios



ATT8 ATTT8 ATTL8 ATTX8 ATF8

NAS

PRO XN2110060 Monocolor especial estrecha / Monocolor especial estreita



6000K 4000K 3000K 24Vdc

IP20 OPCIONAL Págs. 232-233

CRI >80 30.000 h x 15.000

	CCT	IP	(1 m)	(1 m)
XN2110060P2060	6000K	IP20	2450 lm	2160 lm
XN2110060P2040	4000K	IP20	2450 lm	2160 lm
XN2110060P2030	3000K	IP20	2405 lm	2115 lm

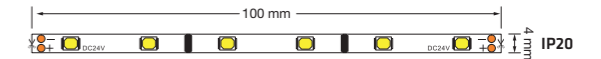

14,4W/m LED 2110 60 LED/m 100 mm

Personalización
Corte a medida



SUEDE

PRO XS2835120 Monocolor especial forma S / Monocolor especial forma S



6000K 4000K 3000K 24Vdc

IP20 OPCIONAL Págs. 232-233

CRI >80 30.000 h x 15.000

	CCT	IP	(1 m)	(1 m)
XS2835120P2060	6000K	IP20	1190 lm	1000 lm
XS2835120P2040	4000K	IP20	1190 lm	1000 lm
XS2835120P2030	3000K	IP20	1180 lm	990 lm



9,6W/m LED 2835 120 LED/m 50 mm

• Accesorios



ATT8 ATTT8 ATTL8 ATTX8 ATF8

TRAKA

PRO T5050300RGB RGB

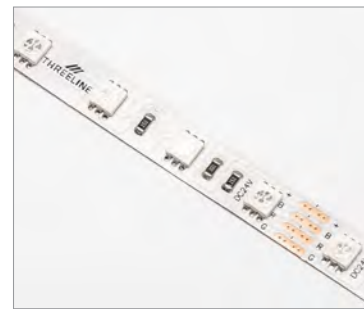

III III	CCT	IP
T5050300RGBIP20	RGB	IP20
T5050300RGBIP67	RGB	IP67

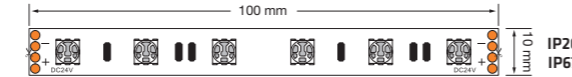

14,4W/m LED 5050 60 LED/m 100 mm

• Accesorios



TRAKA

PRO T5050300RGB+W RGB + 6000K

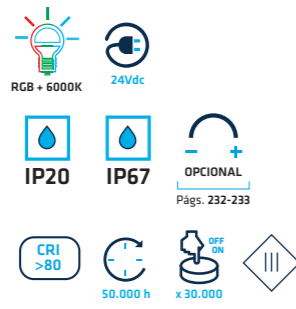

III III	CCT	IP
T5050300RGB+WIP20	RGB + 6000K	IP20
T5050300RGB+WIP67	RGB + 6000K	IP67

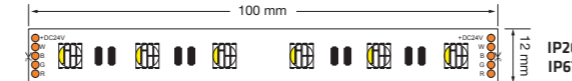

19,2W/m LED 5050 60 LED/m 100 mm

• Accesorios



XUA

PRO XX5050060RG RGB

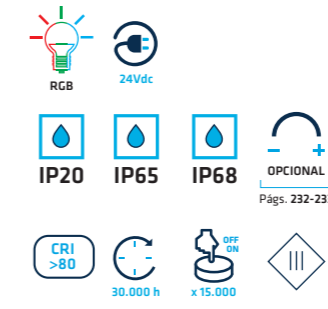
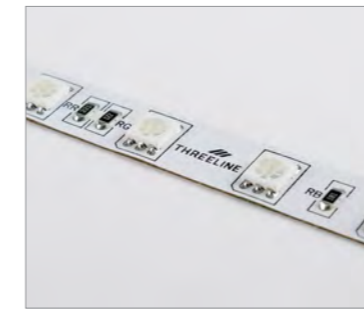

III III	CCT	IP
XX5050060P20RG	RGB	IP20
XX5050060P65RG	RGB	IP65
XX5050060P68RG	RGB	IP68*

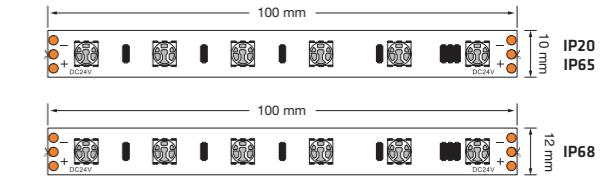

10W/m LED 5050 60 LED/m 100 mm

• Accesorios



XUA

PRO XX5050060RW RGB + 3000K

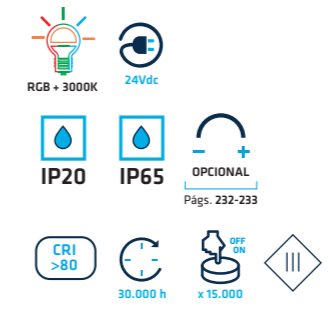
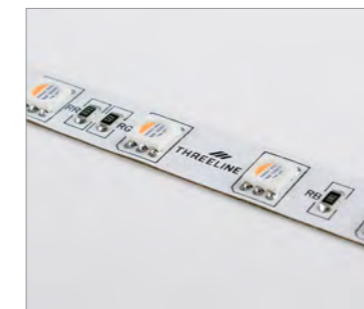

III III	CCT	IP
XX5050060P20RW	RGB + 3000K	IP20
XX5050060P65RW	RGB + 3000K	IP65

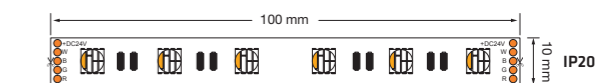

10W/m LED 5050 60 LED/m 100 mm

• Accesorios



*Las tiras IP68 se sirven en rollos de 5 m / *As fitas IP68 são vendidas em rolos de 5m

DUNCAN

PRO XD5050060P65RG Digital RGB

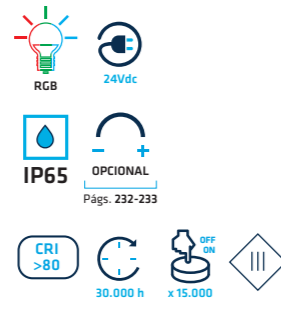
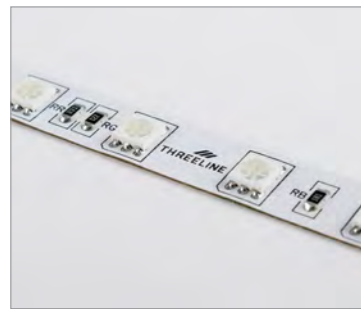

14,4W/m LED 5050 60 LED/m 100 mm

Modelo	CCT	IP
XD5050060P65RG	RGB	IP65

Personalización
Corte a medida



DUNCAN

PRO XD5050060P65RW Digital RGB + 6000K

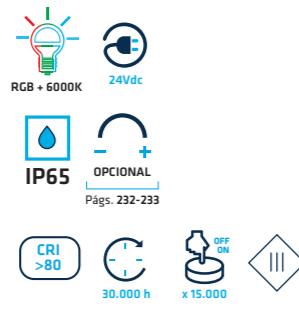
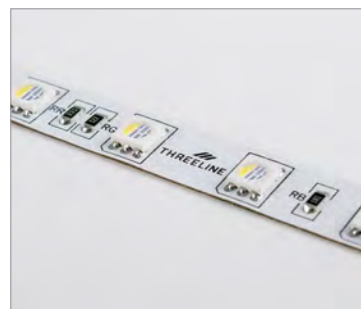

19,2W/m LED 5050 60 LED/m 100 mm

Modelo	CCT	IP
XD5050060P65RW	RGB + 6000K	IP65

Personalización
Corte a medida



TRAKA

PRO T3527300BI Bicolor



9,6W/m LED 3527 60 LED/m 100 mm

Modelo	CCT	IP	N (1 m)	(1 m)
T3527300IP2024VBI	6000K	IP20	910 lm	780 lm
	2700K	IP20	880 lm	670 lm
T3527300IP6724VBI	6000K	IP67	910 lm	780 lm
	2700K	IP67	880 lm	670 lm

Personalización
Corte a medida



TRAKA

PRO T2835560BI Bicolor

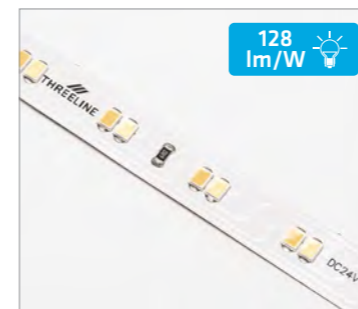

19,2W/m LED 2835 112 LED/m 125 mm

Modelo	CCT	IP	N (1 m)	(1 m)
T2835560IP2024VBI	6000K	IP20	2688 lm	2458 lm
	2700K	IP20	2349 lm	2119 lm
T2835560IP6724VBI	6000K	IP67	2688 lm	2458 lm
	2700K	IP67	2349 lm	2119 lm

Personalización
Corte a medida



TRAKA

PRO **T3528600BI** Bicolor



75
lm/W

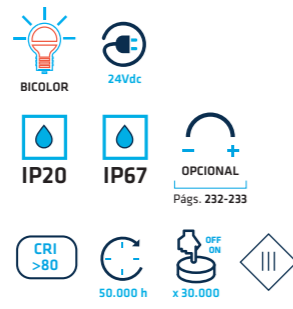

	CCT	IP	(1 m)	(1 m)
T3528600IP2024VBI	● 6000K ● 2700K	IP20	1152 lm	720 lm
T3528600IP6724VBI	● 6000K ● 2700K	IP67	1152 lm	720 lm



9,6W/m LED 3528 120 LED/m 100 mm

Personalización
Corte a medida



BLONDIE

PRO **XB3527060** Bicolor

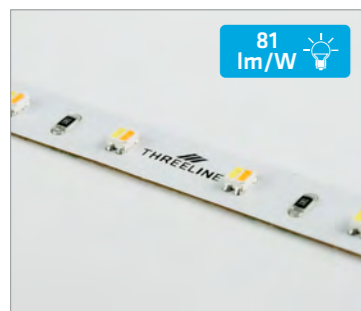

81
lm/W

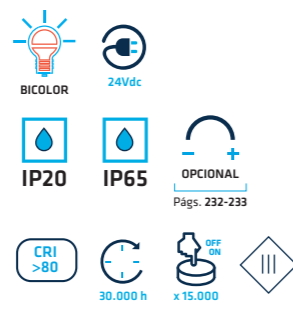

	CCT	IP	(1 m)	(1 m)
XB3527060P20BI	● 6000K ● 2700K	IP20	910 lm	780 lm
XB3527060P65BI	● 6000K ● 2700K	IP65	910 lm	780 lm



9,6W/m LED 3527 60 LED/m 100 mm

Personalización
Corte a medida



BLONDIE

PRO **XB2835112** Bicolor



128
lm/W



	CCT	IP	(1 m)	(1 m)
XB2835112P20BI	● 6000K ● 2700K	IP20	2690 lm	2465 lm
XB2835112P65BI	● 6000K ● 2700K	IP65	2690 lm	2465 lm



19,2W/m LED 2835 112 LED/m 125 mm

BLONDIE

PRO **XB3528120** Bicolor



75
lm/W



	CCT	IP	(1 m)	(1 m)
XB3528120P20BI	● 6000K ● 2700K	IP20	865 lm	720 lm
XB3528120P65BI	● 6000K ● 2700K	IP65	865 lm	720 lm

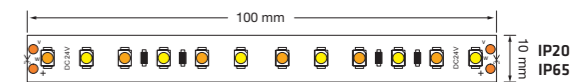

9,6W/m LED 3528 120 LED/m 100 mm

DECORATIVA / DECORATIVA

TRAKA

PRO T3014600 Lateral

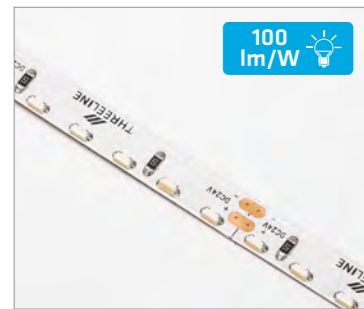

6000K 4000K 2700K 24Vdc

IP20 IP67 OPCIONAL Págs. 232-233

CRI >80 50.000 h x 30.000

	CCT	IP	(1 m)	(1 m)
T3014600IP2024VBF	6000K	IP20	1320 lm	1200 lm
T3014600IP2024VBN	4000K	IP20	1296 lm	1140 lm
T3014600IP2024VBC	2700K	IP20	1260 lm	1080 lm
T3014600IP6724VBF	6000K	IP67	1320 lm	1200 lm
T3014600IP6724VBN	4000K	IP67	1296 lm	1140 lm
T3014600IP6724VBC	2700K	IP67	1260 lm	1080 lm

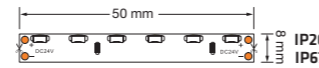

12W/m LED 3014 120 LED/m 50 mm

• Accesorios



ATT8 ATTT8 ATTL8 ATTX8 ATF8



LIZ

PRO XL3014120 Lateral



6000K 4000K 2700K 24Vdc

IP20 IP65 OPCIONAL Págs. 232-233

CRI >80 30.000 h x 15.000

	CCT	IP	(1 m)	(1 m)
XL3014120P2060	6000K	IP20	1320 lm	1200 lm
XL3014120P2040	4000K	IP20	1260 lm	1140 lm
XL3014120P2027	2700K	IP20	1200 lm	1080 lm
XL3014120P6560	6000K	IP65	1320 lm	1200 lm
XL3014120P6540	4000K	IP65	1260 lm	1140 lm
XL3014120P6527	2700K	IP65	1200 lm	1080 lm

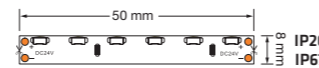

12W/m LED 3014 120 LED/m 50 mm

• Accesorios



ATT8 ATTT8 ATTL8 ATTX8 ATF8

TIRAS LED ACCESORIOS / FITAS LED ACESSÓRIOS

CONEXIÓN TIRA-TIRA / LIGAÇÃO FITA-FITA

Conexión en línea.
Ligação em linha.

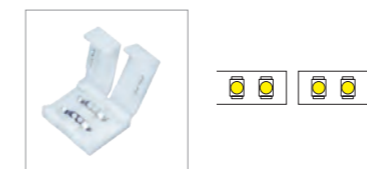

ATT8 2 polos (8 mm)
ATT10 2 polos (10 mm)

Conexión en línea.
Ligação em linha.



ATTRGB 4 polos (10 mm)
ATTRGB+W 5 polos (12 mm)

Conexión con forma de T.
Ligação com forma T.

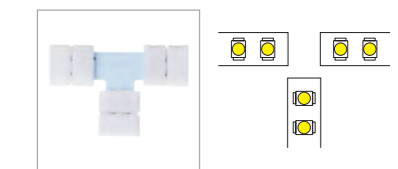

ATTT8 2 polos (8 mm)
ATTT10 2 polos (10 mm)
ATTTRGB 4 polos (10 mm)

Conexión con forma de L.
Ligação com forma L.

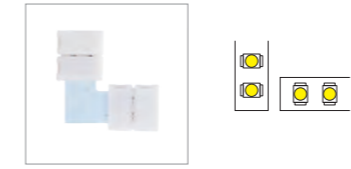

ATTL8 2 polos (8 mm)
ATTL10 2 polos (10 mm)
ATTLRGB 4 polos (10 mm)
ATTLRGB+W 5 polos (12 mm)

Conexión con forma de cruz.
Ligação com forma cruz.

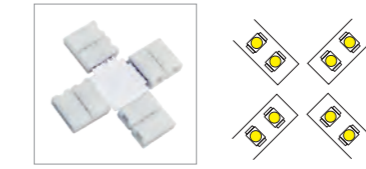

ATTX8 2 polos (8 mm)
ATTX10 2 polos (10 mm)
ATTXRGB 4 polos (10 mm)

CONEXIÓN TIRA-FUENTE / LIGAÇÃO FITA-FONTE

Conexión con fuente.
Ligação com fonte.

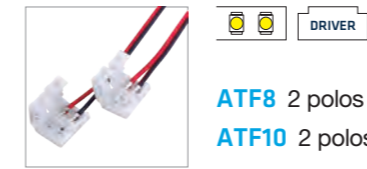

ATF8 2 polos (8 mm)
ATF10 2 polos (10 mm)

Conexión con fuente.
Ligação com fonte.



ATFRGB 4 polos (10 mm)
ATFRGB+W 5 polos (12 mm)

ANCHO DE ACCESORIO EN PERFIL / LARGURA DO ACESSÓRIO NO PERFIL

	8 mm	10 mm	12 mm
PF0619SPAN	X	X	X
PF1414SPAN	X	X	X
PF1708SPAN	X	X	X
PF1714SPAN	X	X	X
PF3011SPAN	✓	✓	✓
PF3021SPAN	✓	✓	✓
PF1919SPAN	✓	✓	X
PF3525SPAN	✓	✓	X
PF3541SPAN	✓	✓	X
PF4235SPAN	✓	✓	X
PF2507SCAN	X	X	X
PF3909SCAN	✓	✓	✓
PF5208SCAN	X	X	X
PF2314EMAN	X	X	X
PF2508EMAN	X	X	X

	8 mm	10 mm	12 mm
PF4435EMAN	✓	✓	X
PF5035EMAN	✓	✓	✓
PF6545EMAN	✓	✓	✓
PF7032EMAN	✓	✓	✓
PF10149EMAN	X	X	X
PF2929CLAN	✓	✓	✓
PF2930CLAN	✓	✓	✓
PF3535CLAN	✓	✓	✓
PF5074CLAN	✓	✓	✓
PF5532CLAN	✓	✓	✓
PF5424ARAN	X	X	X
PF5815ARAN	✓	X	X
PF6320ARAN	✓	✓	✓
PF7435ARAN	✓	✓	✓
PF3545ARAN	✓	✓	✓

	8 mm	10 mm	12 mm
PF6214ARAN	✓	✓	✓
PF1615EQAN	✓	✓	X
PF1818EQAN	X	X	X
PF6826ELAN	X	X	X
PF6628ELAN	✓	X	X
PF2711SLAN	X	X	X
PF1609SLAN	X	X	X
PF1613SLAN	X	X	X
PF2226SLAN	X	X	X
PF4213PDAN	✓	X	X
PF4913PDAN	X	X	X
PF2226SLAN	X	X	X
PF7060PDAN	X	X	X
PF4084PDAN	✓	✓	✓
PF0430TBAN	✓	✓	✓
PF8016RDAN	X	X	X

ABBA

PRO XA2835075 230Vac



128 lm/W
reales/reais

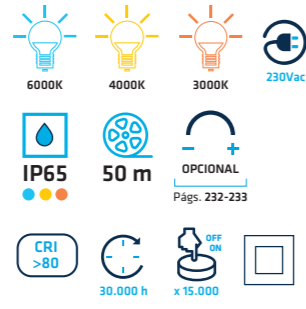

	CCT	IP	(1 m)	(1 m)
XA2835075P6560	6000K	IP65	1035 lm	895 lm
XA2835075P6540	4000K	IP65	1035 lm	895 lm
XA2835075P6530	3000K	IP65	1015 lm	875 lm

7W/m LED 2835 75 LED/m 200 mm

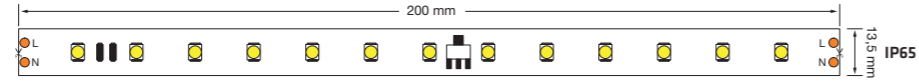

• Accesorios 230Vac



AAL220
Conector alimentación tira 230Vac.
Ligador alimentação fita 230Vac.



ATT220
Accesorio conexión tira tira 230Vac.
Acessório de ligação fita a fita 230Vac.



AST220
Accesorio sujeción tira 230Vac (2 uds.)
Acessório de fixação fita 230Vac (2 uni.)



TFT220
Tapa final tira 230Vac.
Tampa remate fita 230Vac.

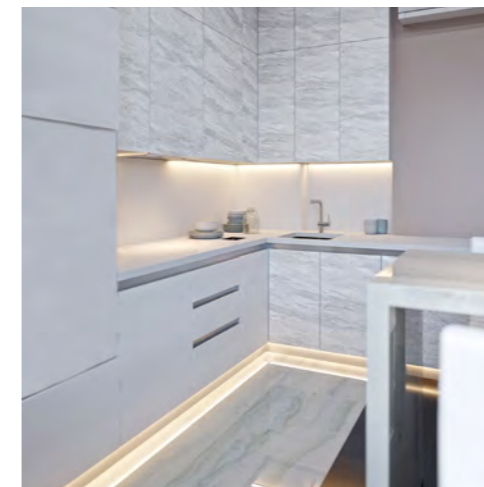
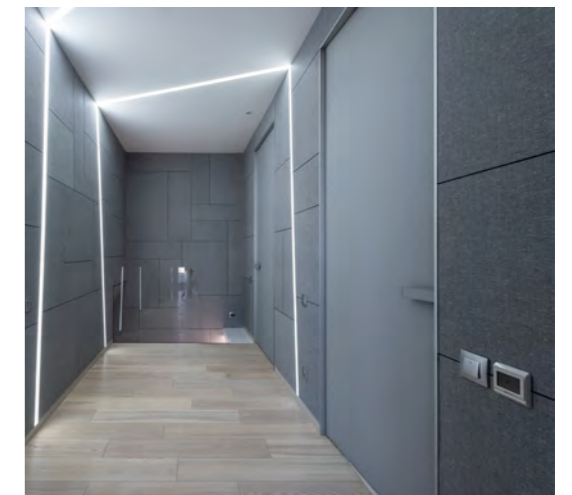









DECORATIVA / DECORATIVA





CONTROLADORES









TIRAS LED





230Vac	TIRAS LED						24Vcc					AMPLIFICADORES
	TIRAS LED						TIRAS DIGITALES					
CORTE DE FASE	0/1-10V	DALI	PARED	PARED RF	PARED + MANDO RF	MANDO RF	MANDO MULTIZONA RF	DMX	SLESA	CASAMBI	SMART HOME	









 PCD240W Pág. 266	 TDIM12A Pág. 268	 CRTDAW Pág. 269	 4TW Pág. 270		 4TRTW Pág. 272	 RTW Pág. 273
---	---	--	---	--	---	---

 RTMZW R3MWBI Pág. 274	 CTRSCNRGB Pág. 275	 SLESA Pág. 300	 CSB1224DC Pág. 276	 SMART-CRT Pág. 277	 CTRXD Pág. 267	 AMPLEDW Pág. 286
	 CTRDECDMX Pág. 275					

		 CRTDARGBI Pág. 269	 4TBI Pág. 270		 4TRTBI Pág. 272	 RTBI Pág. 273
--	--	---	--	--	--	--

 RTMZBI R3MWBI Pág. 274	 CTRSCNRGB Pág. 275	 SLESA Pág. 300	 CSB1224DC Pág. 276	 SMART-CRT Pág. 277	 CTRXD Pág. 267	 AMPLEDBI Pág. 286
	 CTRDECDMX Pág. 275					

		 CRTDARGBI Pág. 269	 4TRGB Pág. 270		 4TRTRGB Pág. 272	 RTRGB Pág. 273
						 CTRLDRGB Pág. 273

 RTMZRGBW R4MRGBW Pág. 274	 CTRSCNRGB Pág. 275	 SLESA Pág. 300	 CSB1224DC Pág. 276	 SMART-CRT Pág. 277	 CTRXD Pág. 267	 AMPLEDRGB Pág. 286
	 CTRDECDMX Pág. 275					 AMPLEDRGB Pág. 286

		 CRTDARGB+W Pág. 269	 4TRGB+W Pág. 270	 4TDX8 DX8RF Pág. 259	 4TRTRGB+W Pág. 272	 RTRGB+W Pág. 273
--	--	--	---	--	---	---

 RTMZRGBW R4MRGBW Pág. 274	 CTRDMXRGB+W Pág. 275	 SLESA Pág. 300	 CSB1224DC Pág. 276	 SMART-CRT Pág. 277	 CTRXD Pág. 267	 AMPLEDRGB+W Pág. 286
--	---	---	---	---	---	---

ANCHO DE TIRAS LED / LARGURA DA FITAS LED

MONOCOLOR	TRAKA T3528300 IP20 IP67 8 mm	TRAKA T5050300RGB+W IP20 IP67 12 mm
	TRAKA T3528600 IP20 IP67 8 mm	XUA XX5050060RG IP20 IP65 10 mm 12 mm
	TRAKA T5050150 IP20 IP67 10 mm	XUA XX5050060RW IP20 IP65 10 mm
	TRAKA T5050300 IP20 IP67 10 mm	DUNCAN XD5050060P65RG IP65 10 mm
	MANA XM2835060 IP20 IP65 8 mm	DUNCAN XD5050060P65RW IP65 10 mm
	MANA XM2835120 IP20 IP65 8 mm 10 mm	TRAKA T3527300BI IP20 IP67 10 mm
MONOCOLOR ALTA EFICIENCIA	MANA XM5050060 IP20 IP65 10 mm 12 mm	TRAKA T2835560BI IP20 IP67 10 mm
	TRAKA T2835490 IP20 IP67 8 mm	TRAKA T3528600BI IP20 IP67 10 mm
	TRAKA T5630300 IP20 IP67 10 mm	BLONDIE XB3527060 IP20 IP65 10 mm
	HALEN XH2835060 IP20 IP65 8 mm	BLONDIE XB2835112 IP20 IP65 10 mm
	HALEN XH2835120 IP20 IP65 8 mm	BLONDIE XB3528120 IP20 IP65 10 mm
	HALEN XH2835240 IP20 16 mm	TRAKA T3014600 IP20 IP67 8 mm
ALTA DENSIDAD	PRIEST XP2835240 IP20 8 mm	LIZ XL3014120 IP20 IP65 8 mm
	MONOCOLOR ESPECIAL	ABBA XA2835075 IP65 13,5 mm
NAS XN2110060 IP20 4 mm		
SUEDE XS2835120 IP20 8 mm		
TRAKA T5050300RGB IP20 IP67 10 mm		

ANCHO MÁX. DE TIRA EN PERFILES / LARGURA MAX. DA FITA EM PERFIS

SUPERFICIE - TIBER PF0619SPAN > 8 < PF1414SPAN > 12,7 < PF1708SPAN > 12,4 < PF1714SPAN > 12,4 < PF3011SPAN > 27,4 < PF3021SPAN > 27,4 < PF1919SPAN > 17,1 < PF3525SPAN > 13 < > 13 < PF3541SPAN > 13 < > 13 < PF4235SPAN > 13 < > 13 <	SUPERFICIE CURVA - BENI PF2507SCAN > 12,5 < PF3909SCAN > 27 < PF5208SCAN > 12,8 < 	EMPOTRABLE - NILE PF2314EMAN > 12,4 < PF2508EMAN > 12,4 < PF4435EMAN > 12 < > 12 < PF5035EMAN > 13 < > 13 < PF6545EMAN > 16 < PF7032EMAN > 15,7 < > 15,7 < PF10149EMAN > 12,3 < > 12,3 <
COLGABLE SUPERFICIE - LEAN PF2929CLAN > 20,3 < PF2930CLAN > 17,7 < PF3535CLAN > 12,7 < > 12,7 < PF5074CLAN > 20,7 < > 31,9 < PF5532CLAN > 19,2 <	ARQUITECTÓNICO - ACRE PF5424ARAN > 12,4 < PF5815ARAN > 12,5 < PF6320ARAN > 19 < PF7435ARAN > 16 < > 16 < PF3545ARAN > 19,5 < 	ESQUINAS - KONDA PF6214ARAN > 21 < PF1615EQAN > 10,6 < PF1818EQAN > 12,5 <
SUELO - SELE PF2711SLAN > 12,2 < PF1609SLAN > 13,1 < PF1613SLAN > 13,2 < PF2226SLAN > 12,5 < 	RODAPIÉS - GANGES PF8016RDAN > 10,1 <	
PARED - EBRO PF4213PDAN > 12,6 < PF4913PDAN > 12,4 < > 12,4 < PF7060PDAN > 14 < PF4084PDAN > 30,7 < > 30,7 < 	TUBOS - OKOA PF0430TBAN > 19,6 <	
CHAPAS DE DISIPACIÓN - DAO PF1503CHAN > 15 < PF1508CHAN > 14,6 < PF1515CHAN > 15 < PF1235CHAN > 35 <	ANCHO MÁXIMO DE TIRA > XX,X < Medidas en mm.	

DECORATIVA / DECORATIVA

Perfiles Perfis



TIBER

PRD PF0619SPAN Superficie, especial tira LED lateral / Superficie, especial fita LED lateral

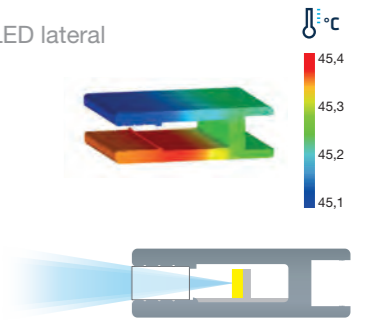
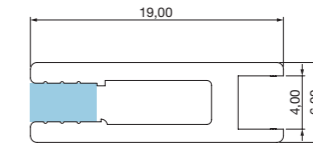
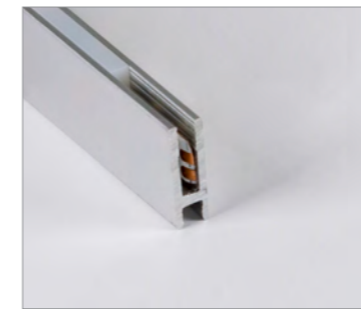

- 12W/m máx.
- 8 mm máx.
- 158 g/m
- IK08

TIBER

PRD PF1414SPAN Superficie / Superficie

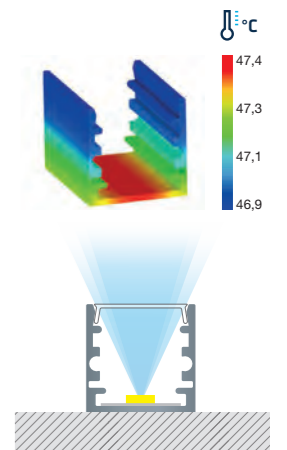
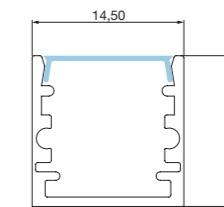

- 19,2W/m máx.
- 12,7 mm máx.
- 136 g/m
- IK08

- Tapas (incl.) Ref.: [TAPF1414SP](#)
- Clips (incl.) Ref.: [CLPF1414SP](#)

TIBER

PRD PF1708SPAN Superficie / Superficie

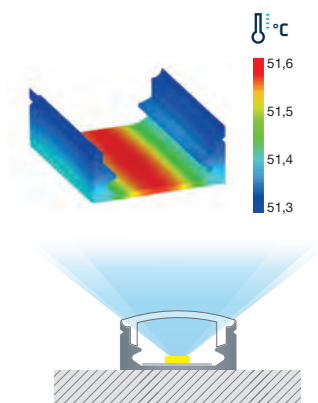
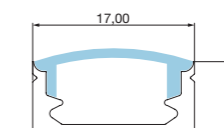

- 19,2W/m máx.
- 12,4 mm máx.
- 114 g/m
- IK08

- Tapas (incl.) Ref.: [TAPF1708SP](#)
- Clips (incl.) Ref.: [CLPF1708SP](#)

• Accesorios



- DFP01127VEC1M
- DFP01124ROC1M
- DFP01123NEC1M
- DFP01126AZC1M
- DFP01125NAC1M

Medidas en milímetros / Medidas em milímetros

TIBER

PRO PF1714SPAN Superficie / Superfície



- Tapas (incl.) Ref.:
TAPF1714SP
- Clips (incl.) Ref.:
CLPF1714SP

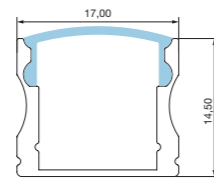
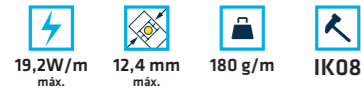

• Accesorios

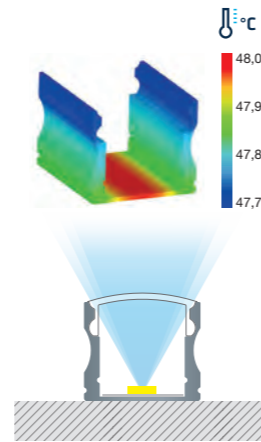

TIBER

PRO PF3011SPAN Superficie / Superfície



- Tapas (incl.) Ref.:
TAPF3011SP
- Clips (incl.) Ref.:
CLPF3011SP

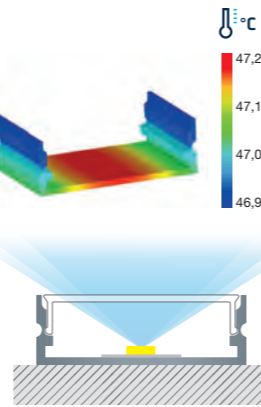
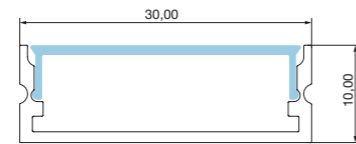
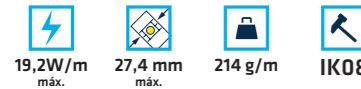

TIBER

PRO PF3021SPAN Superficie / Superfície



- Tapas (incl.) Ref.:
TAPF3021SP
- Clips (incl.) Ref.:
CLPF3021SP

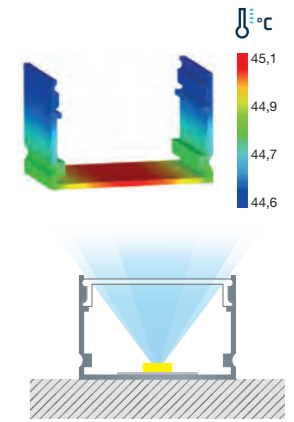
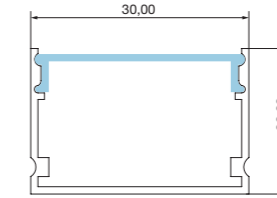
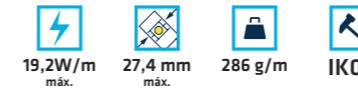

TIBER

PRO PF1919SPAN Superficie, difusor curvo / Superfície, difusor curvo



- Tapas (incl.) Ref.:
TAPF1919SP

• Accesorios

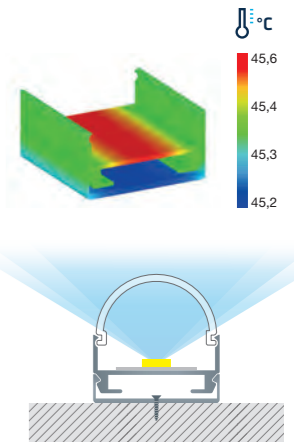
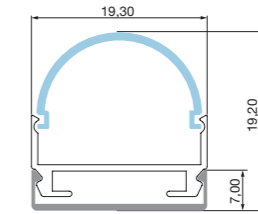
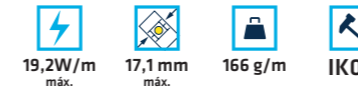
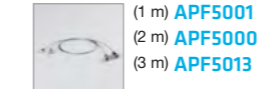

TIBER

PRO PF3525SPAN Superficie / Superfície



- Tapas (incl.) Ref.:
TAPF3525SP

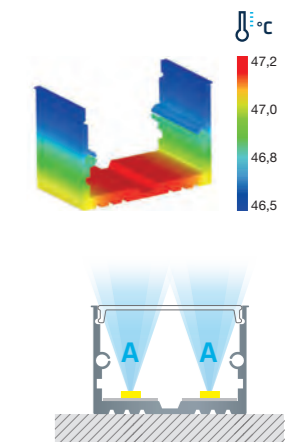
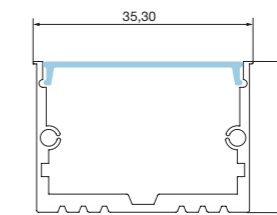
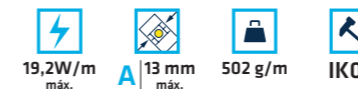

TIBER

PRO PF3541SPAN Superficie, iluminación lateral / Superfície, iluminação lateral



• Tapas (incl.) Ref.:
TAPF3541SP

• Accesorios



19,2W/m máx. 13 mm máx. 774 g/m IK08

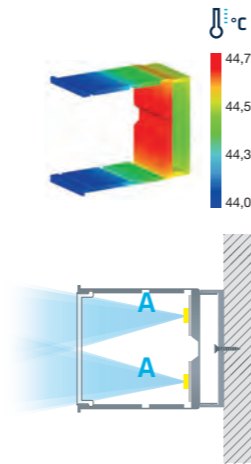
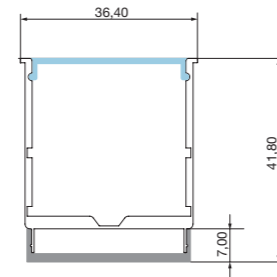

TIBER

PRO PF4235SPAN Superficie / Superfície



• Tapas (incl.) Ref.:
TAPF4235SP

19,2W/m máx. 13 mm máx. 736 g/m IK08

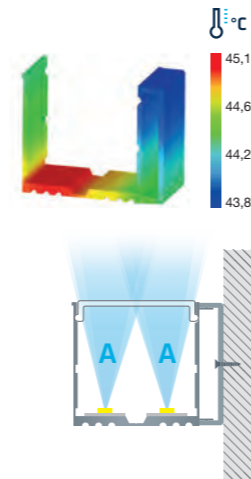
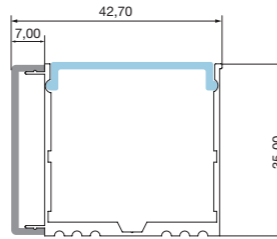

BENI

PRO PF2507SCAN Superficie, con solapas curvas / Superfície, com abas curvas



• Tapas (incl.) Ref.:
TAPF2507SC

• Clips (incl.) Ref.:
CLPF2507SC

19,2W/m máx. 12,5 mm máx. 162 g/m IK08

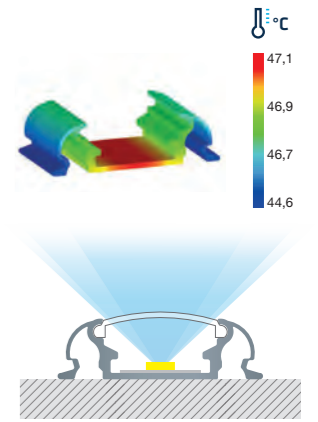
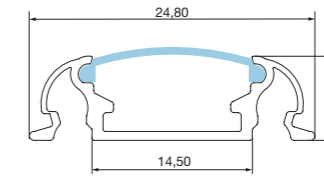

BENI

PRO PF3909SCAN Superficie, con solapas curvas / Superfície, com abas curvas

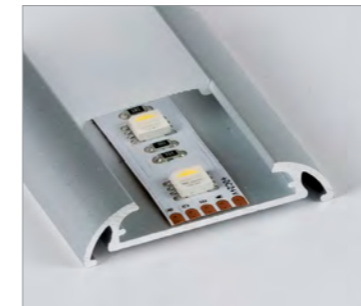

• Tapas (incl.) Ref.:
TAPF3909SC

• Clips (incl.) Ref.:
CLPF3909SC

19,2W/m máx. 27 mm máx. 230 g/m IK08

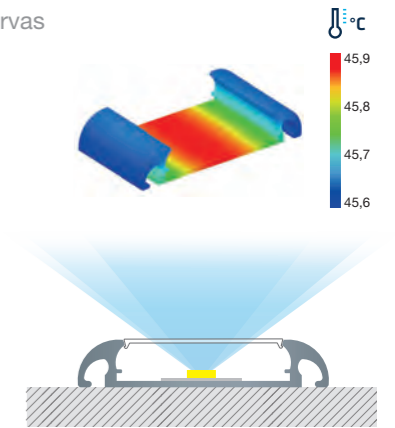
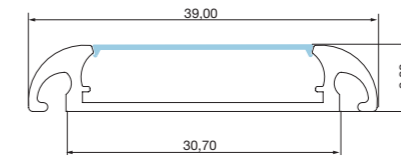

BENI

PRO PF5208SCAN Superficie, con solapas curvas / Superfície, com abas curvas

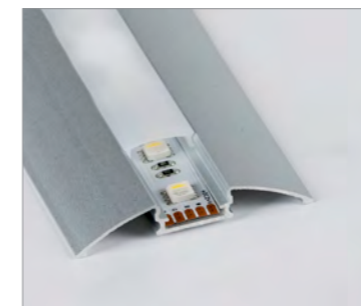

• Tapas (incl.) Ref.:
TAPF5208SC

• Clips (incl.) Ref.:
CLPF5208SC

19,2W/m máx. 12,8 mm máx. 176 g/m IK08

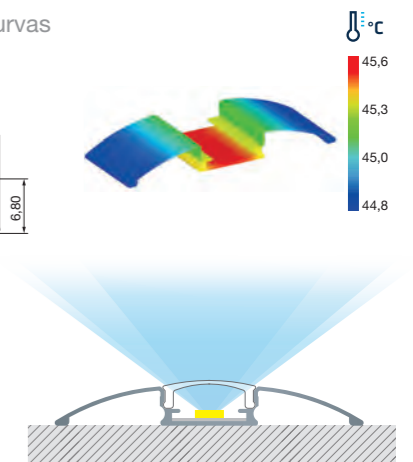
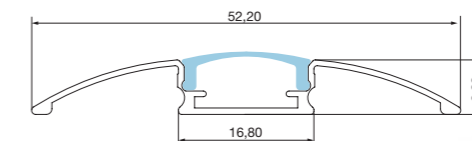

NILE

PRO PF2314EMAN Empotrar / Encastrar

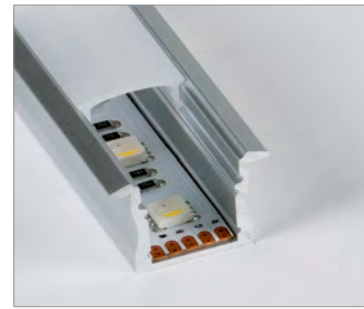

• Tapas (incl.) Ref.:
TAPF2314EM

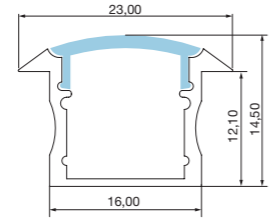

• Accesorios

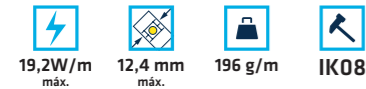
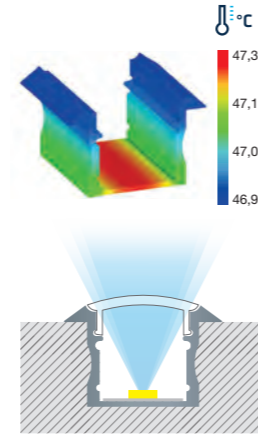

NILE

PRO PF2508EMAN Empotrar / Encastrar



• Tapas (incl.) Ref.:
TAPF2508EM

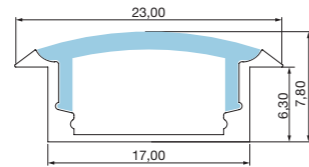

• Accesorios

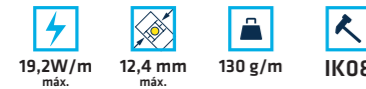
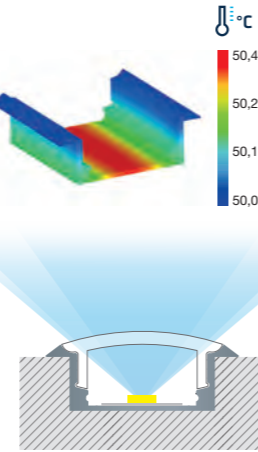

NILE

PRO PF4435EMAN Empotrar / Encastrar



• Tapas (incl.) Ref.:
TAPF4435EM

• Accesorios

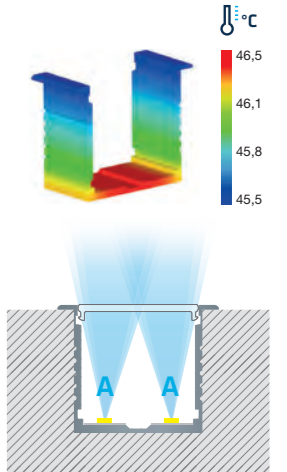
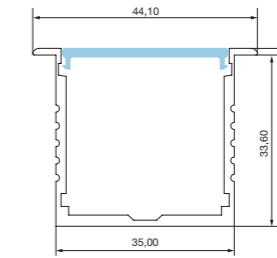

NILE

PRO PF5035EMAN Empotrar / Encastrar

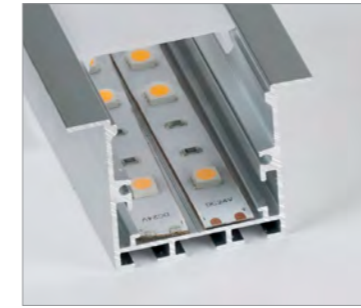

• Tapas (incl.) Ref.:
TAPF5035EM

• Accesorios

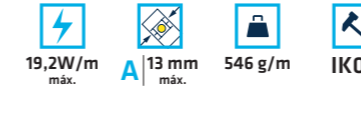

DFP1322C1M

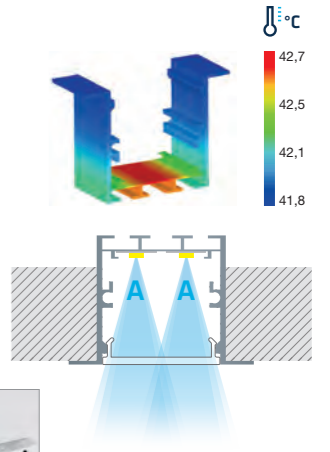
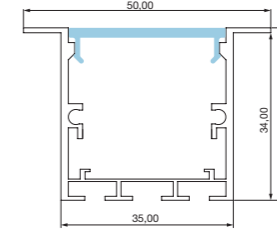

NILE

PRO PF6545EMAN Empotrar / Encastrar



• Tapas (incl.) Ref.:
TAPF6545EM

• Accesorios



APF5003

APF5005

APF5007

APF5008

APF5009

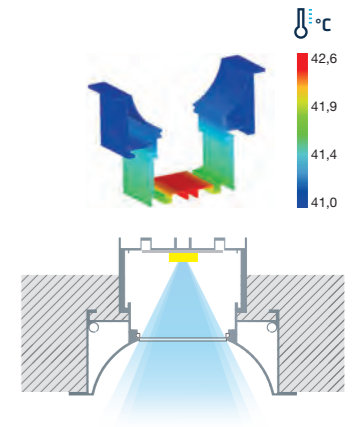
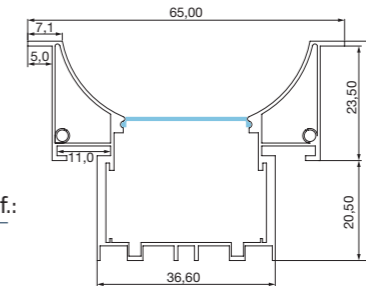

NILE

PRO PF7032EMAN Empotrar / Encastrar

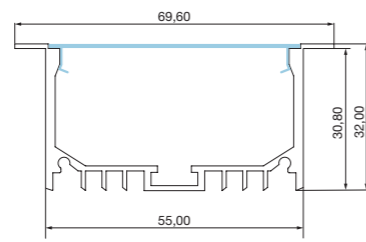

• Tapas (incl.) Ref.:
TAPF7032EM

• Accesorios

19,2W/m máx. 15,7 mm máx. 758 g/m IK08

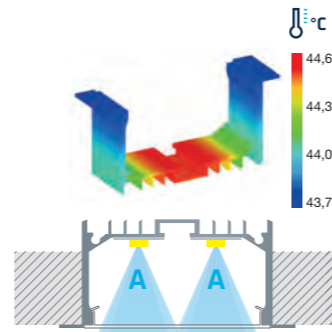

NILE

PRO PF10149EMAN Empotrar, iluminación indirecta. 2 tiras LED / Encastrar, iluminação indireta. 2 fitas LED

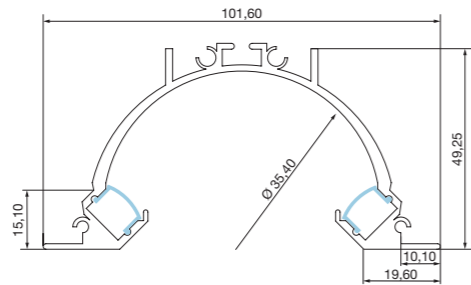

• Tapas (incl.) Ref.:
TAPF10149EM

• Accesorios

19,2W/m máx. 12,3 mm máx. 1150 g/m IK08

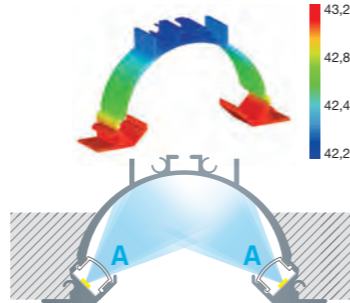

Medidas en milímetros / Medidas em milímetros

LEAN

PRO PF2929CLAN Superficie o suspensión, difusor curvo / Superfície ou suspensão, difusor curvo.



• Tapas (incl.) Ref.:
TAPF2929CL

• Accesorios

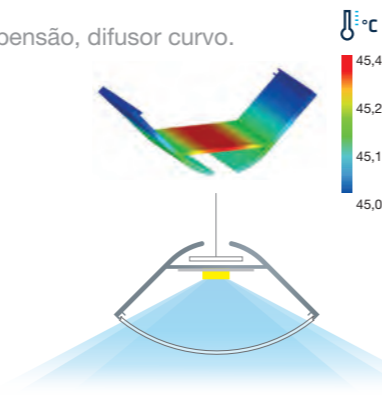
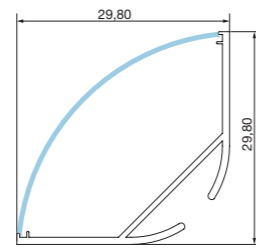

- 19,2W/m máx.
- 20,3 mm máx.
- 228 g/m
- IK08

- APF5005**
- APF5007**
- APF5001** (1 m)
- APF5000** (2 m)
- APF5013** (3 m)

LEAN

PRO PF2930CLAN Superficie o suspensión, difusor cuadrado / Superfície ou suspensão, difusor quadrado.



• Tapas (incl.) Ref.:
TAPF2930CL

• Accesorios

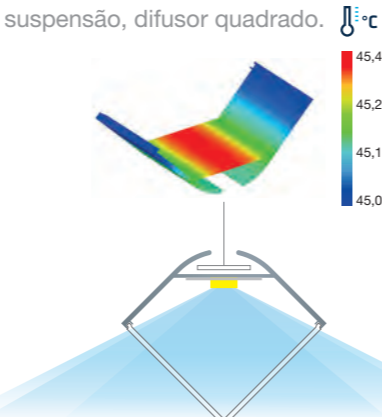
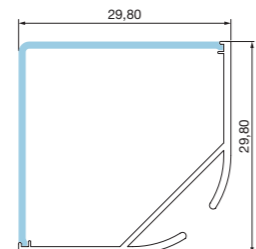

- 19,2W/m máx.
- 17,7 mm máx.
- 244 g/m
- IK08

- APF5005**
- APF5007**
- APF5001** (1 m)
- APF5000** (2 m)
- APF5013** (3 m)

Medidas en milímetros / Medidas em milímetros

LEAN

PRO PF3535CLAN Superficie o suspensión / Superfície ou suspensão



• Tapas (incl.) Ref.:
TAPF3535CL

• Accesorios

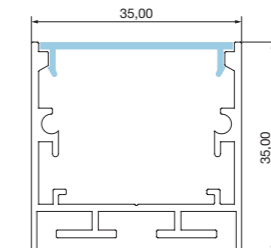

- APF5001** (1 m)
- APF5000** (2 m)
- APF5013** (3 m)

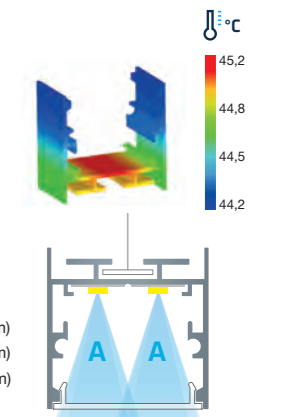

- 19,2W/m máx.
- 12,7 mm máx.
- 552 g/m
- IK08

- APF5002**
- APF5005**
- APF5007**
- APF5008**
- APF5009**
- DFP1322CIM**

LEAN

PRO PF5074CLAN Suspensión, iluminación directa e indirecta / Suspensão, iluminação direta e indireta

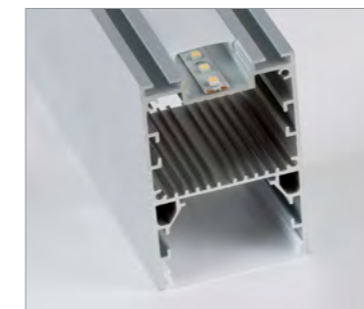

• Tapas (incl.) Ref.:
TAPF5074CL

• Accesorios

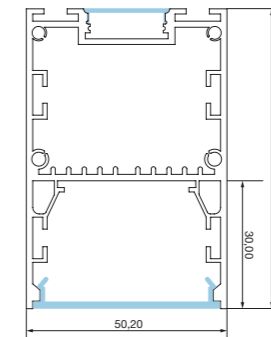

- APF5001** (1 m)
- APF5000** (2 m)
- APF5013** (3 m)

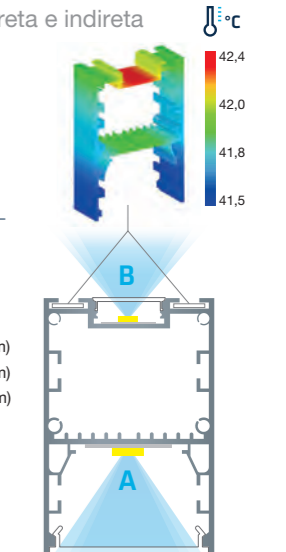

- 19,2W/m máx.
- 31,9 mm máx.
- 20,7 mm máx.
- 1486 g/m
- IK08

- APF5005**
- APF5007**
- APF5008**
- APF5009**

LEAN

PRO PF5532CLAN Superficie o suspensión / Superfície, ou suspensão



• Tapas (incl.) Ref.:
TAPF5532CL

• Accesorios

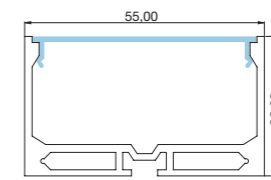

- APF5001** (1 m)
- APF5000** (2 m)
- APF5013** (3 m)

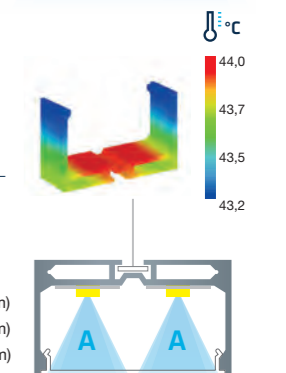

- 19,2W/m máx.
- 19,2 mm máx.
- 870 g/m
- IK08

- APF5002**
- APF5005**
- APF5007**
- APF5008**
- APF5009**

Medidas en milímetros / Medidas em milímetros

DECORATIVA / DECORATIVA

ACRE

PRO PF5424ARAN Arquitectónico, esquinas / Arquitectónico, cantos

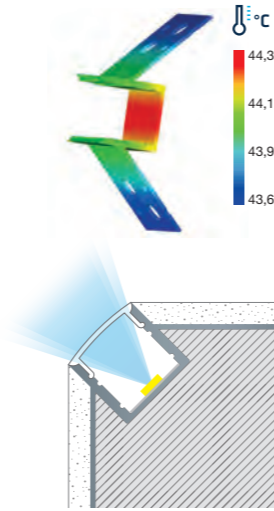
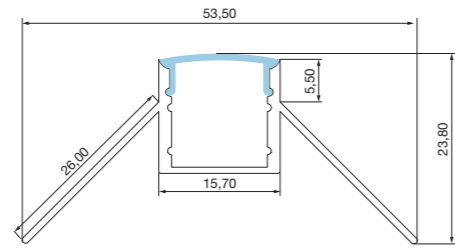
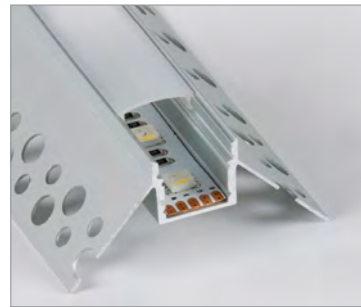

• Tapas (incl.) Ref.:
TAPF5424AR

- 19,2W/m máx.
- 12,4 mm máx.
- 238 g/m
- IK08

ACRE

PRO PF5815ARAN Arquitectónico, empotrar / Arquitectónico, encastrar

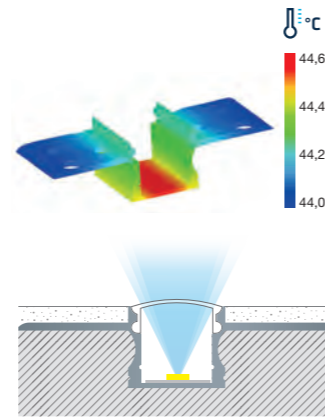
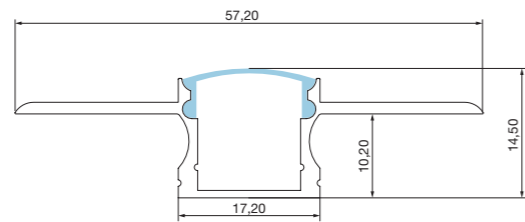

• Tapas (incl.) Ref.:
TAPF5815AR

- 19,2W/m máx.
- 12,5 mm máx.
- 232 g/m
- IK08

ACRE

PRO PF6320ARAN Arquitectónico, empotrar / Arquitectónico, encastrar

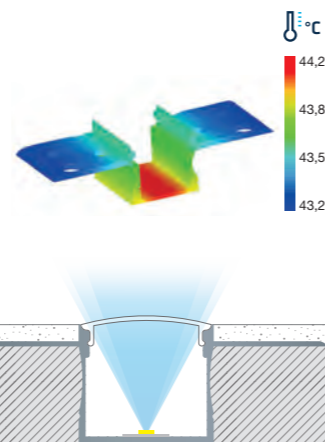
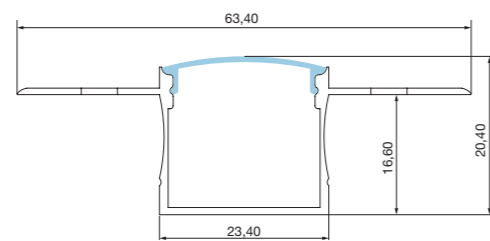
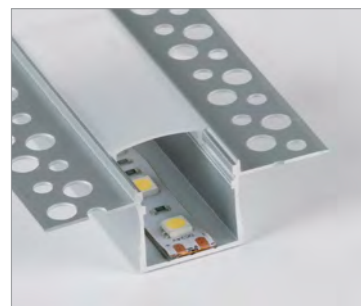

• Tapas (incl.) Ref.:
TAPF6320AR

- 19,2W/m máx.
- 19 mm máx.
- 296 g/m
- IK08

Medidas en milímetros / Medidas em milímetros

ACRE

PRO PF7435ARAN Arquitectónico, empotrar / Arquitectónico, encastrar

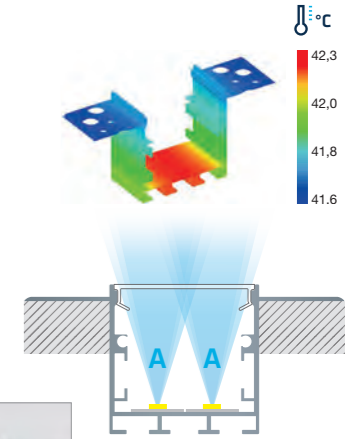
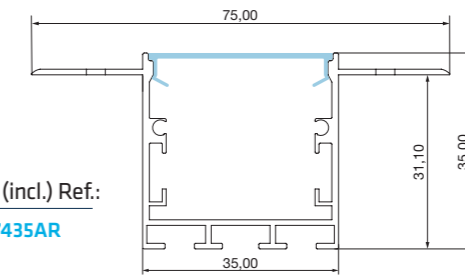
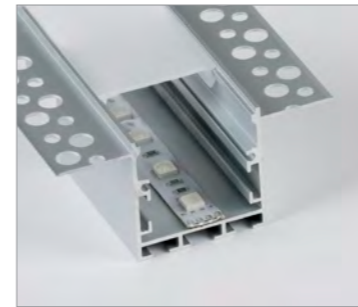

• Tapas (incl.) Ref.:
TAPF7435AR

• Accesorios

- 19,2W/m máx.
- 16 mm máx.
- 616 g/m
- IK08

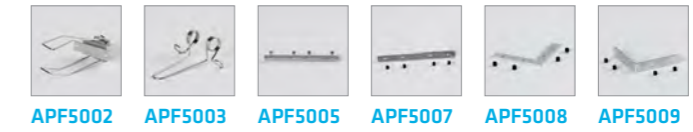

ACRE

PRO PF3545ARAN Arquitectónico, falso techo / Arquitectónico, tecto falso

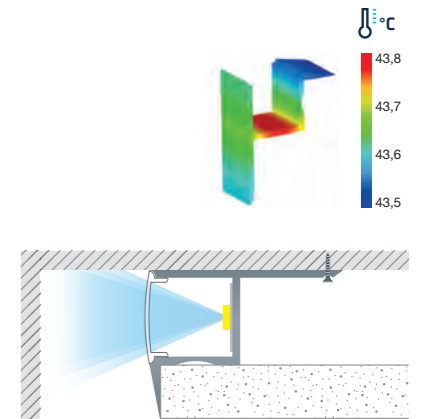
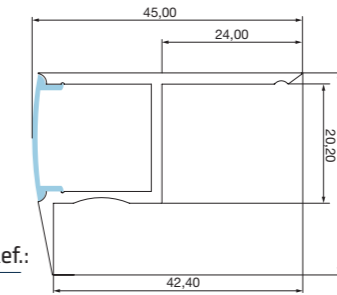

• Tapas (incl.) Ref.:
TAPF3545AR

- 19,2W/m máx.
- 19,5 mm máx.
- 476 g/m
- IK08

ACRE

PRO PF6214ARAN Arquitectónico, pared con baldosa / Arquitectónico, parede com aulejo

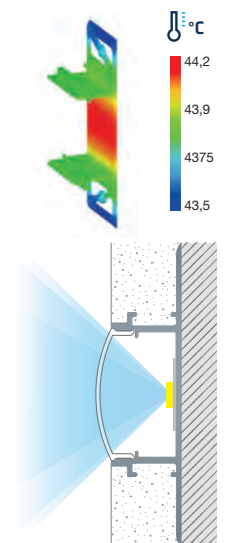
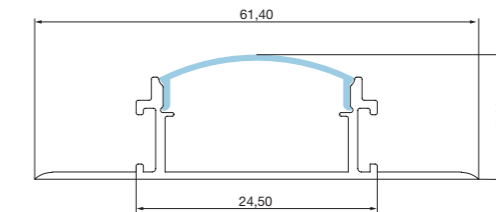
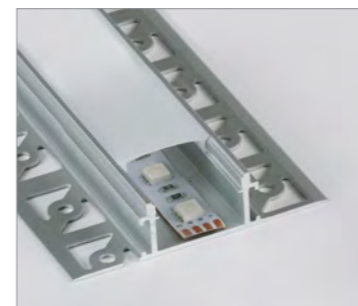

• Tapas (incl.) Ref.:
TAPF6214AR

• Accesorios

- 19,2W/m máx.
- 21 mm máx.
- 294 g/m
- IK08



Medidas en milímetros / Medidas em milímetros

KONDA

PRO PF1615EQAN Superficie para esquina 90° / Superfície para canto 90°



- Tapas (incl.) Ref.:
TAPF1615EQ
- Ref. clips
CLPF1615EQ

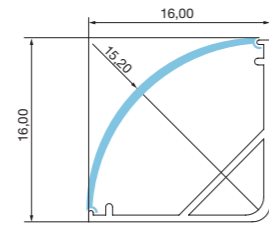

- 19,2W/m máx.
- 10,6 mm máx.
- 100 g/m
- IK08

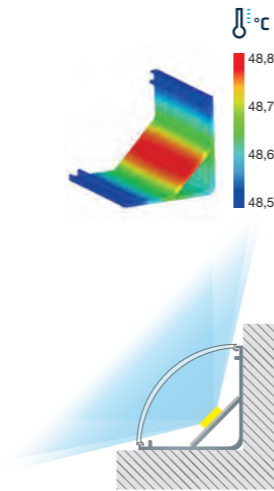
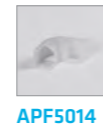

KONDA

PRO PF1818EQAN Superficie para esquina 60° / Superfície para canto 60°



- Tapas (incl.) Ref.:
TAPF1818EQ
- Clips (incl.) Ref.:
CLPF1818EQ
- Accesorios

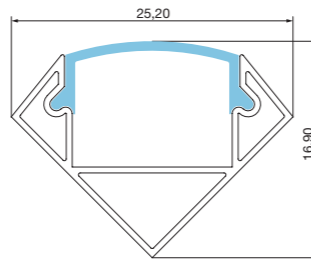

- 19,2W/m máx.
- 12,5 mm máx.
- 168 g/m
- IK08

- DFP1122C1M
- DFP01127VEC1M
- DFP01124ROC1M
- DFP01123NEC1M
- DFP01126AZC1M
- DFP01125NAC1M

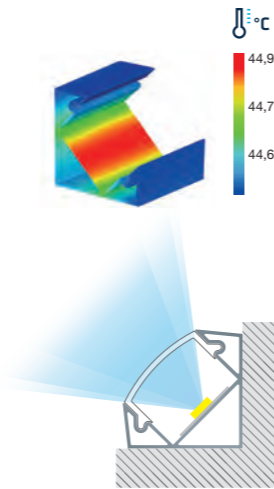

Medidas en milímetros / Medidas em milímetros

RENO

PRO PF6826ELAN Escalera, iluminación inferior / Escada, iluminação inferior



- Tapas (incl.) Ref.:
TAPF6826EL

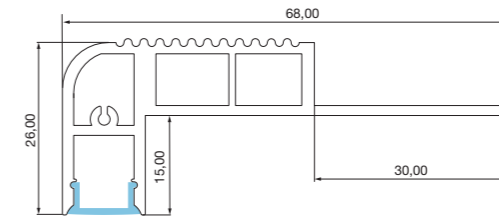

- 19,2W/m máx.
- 9,5 mm máx.
- 656 g/m
- IK08

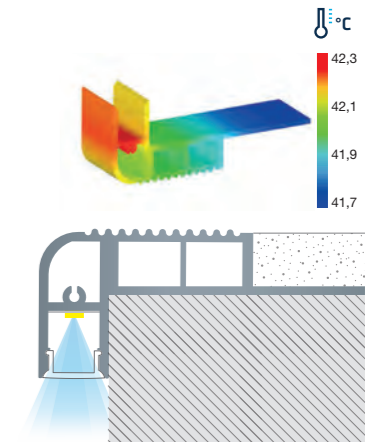

RENO

PRO PF6628ELAN Escalera, iluminación superior / Escada, iluminação superior



- Tapas (incl.) Ref.:
TAPF6628EL

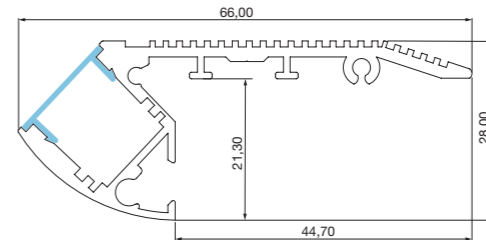

- 19,2W/m máx.
- 12,4 mm máx.
- 632 g/m
- IK08

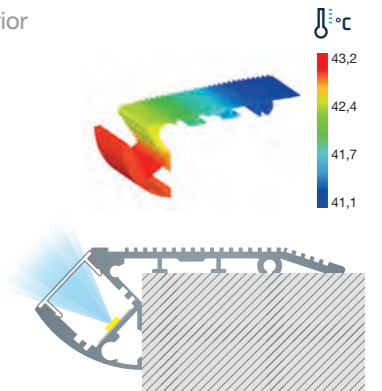

Medidas en milímetros / Medidas em milímetros

SELE

PRO PF2711SLAN Empotrar en suelo con solapas / Encastrar no chão, com abas

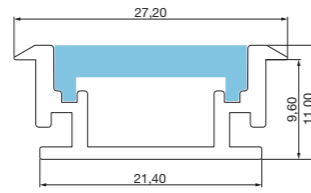

• Tapas (incl.) Ref.:
TAPF2711SL

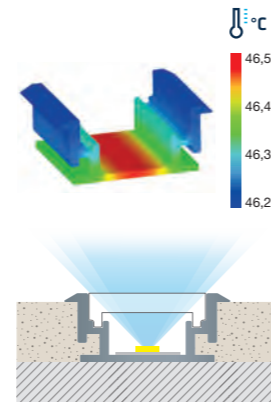

- 19,2W/m máx.
- 12,2 mm máx.
- 262 g/m
- IK08

SELE

PRO PF1609SLAN Empotrar en suelo sin solapas / Encastrar no chão, sem abas

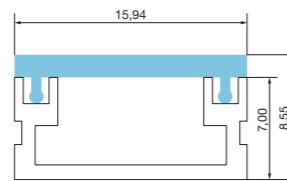
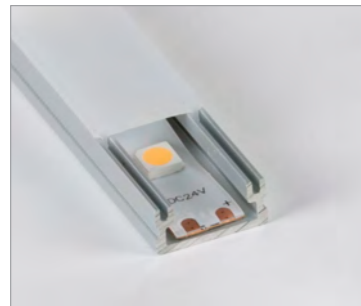

• Tapas (incl.) Ref.:
TAPF1609SL

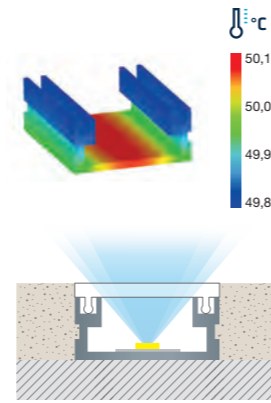

- 19,2W/m máx.
- 13,1 mm máx.
- 132 g/m
- IK08

SELE

PRO PF1613SLAN Empotrar en suelo sin solapas / Encastrar no chão, sem abas

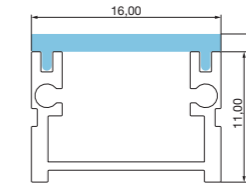
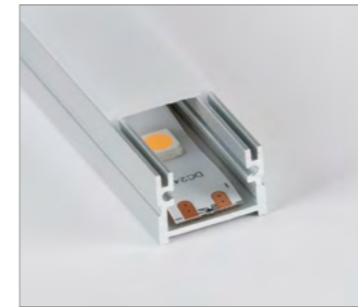

• Tapas (incl.) Ref.:
TAPF1613SL

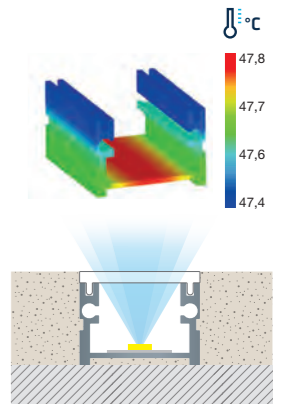

- 19,2W/m máx.
- 13,2 mm máx.
- 150 g/m
- IK08

SELE

PRO PF2226SLAN Empotrar en suelo arista del perfil vista / Encastrar no chão, borda de vista de perfil

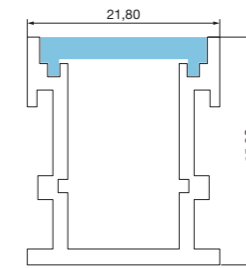

• Tapas (incl.) Ref.:
TAPF2226SL

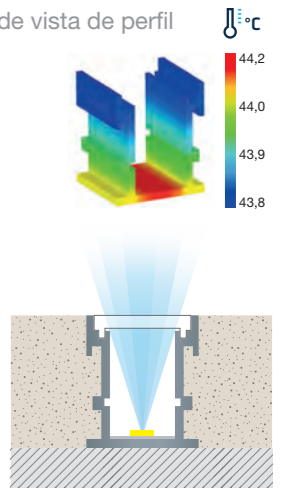

- 19,2W/m máx.
- 12,5 mm máx.
- 412 g/m
- IK08

EBRO

PRO PF4213PDAN Superficie para pared, iluminación indirecta / Superfície na parede, iluminação indireta



• Tapas (incl.) Ref.:
TAPF4213PD

• Clips (incl.) Ref.:
CLPF4213PD

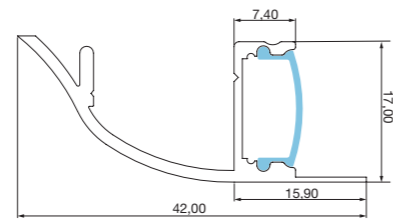

• Accesorios



- DFP01127VEC1M
- DFP01124ROC1M
- DFP01123NEC1M
- DFP01126AZC1M
- DFP01125NAC1M

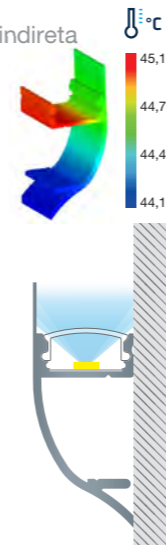

- ⚡ 19,2W/m máx.
- ⊗ 12,6 mm máx.
- 📏 264 g/m
- 🔧 IK08

EBRO

PRO PF4913PDAN Superficie para pared, iluminación indirecta / Superfície na parede, iluminação indireta



• Tapas (incl.) Ref.:
TAPF4913PD

• Clips (incl.) Ref.:
CLPF4913PD

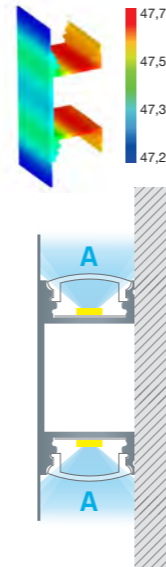
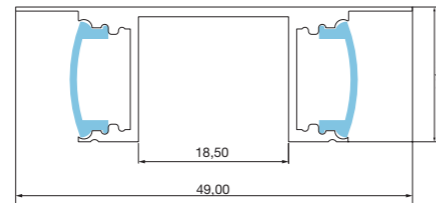

- ⚡ 19,2W/m máx.
- ⊗ 12,4 mm máx.
- 📏 326 g/m
- 🔧 IK08

Medidas en milímetros / Medidas em milímetros

EBRO

PRO PF7060PDAN Empotrar en pared, iluminación indirecta / Encastrar na parede, iluminação indireta



• Tapas (incl.) Ref.:
TAPF7060PD

• Accesorios

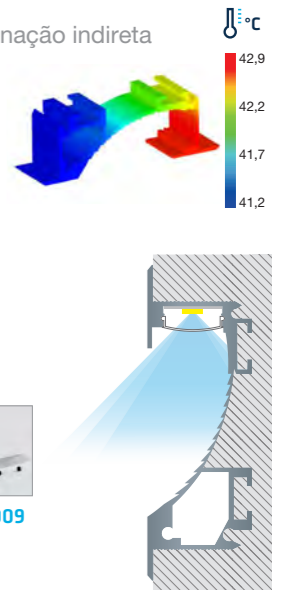
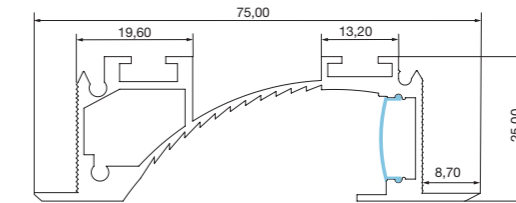

- ⚡ 19,2W/m máx.
- ⊗ 14 mm máx.
- 📏 718 g/m
- 🔧 IK08

EBRO

PRO PF4084PDAN Superficie para pared, iluminación indirecta / Superfície na parede, iluminação indireta

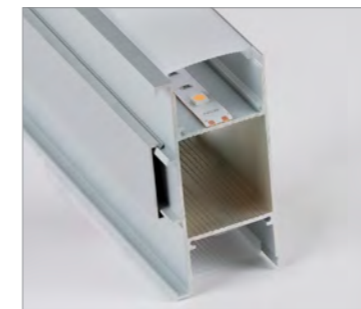

• Tapas (incl.) Ref.:
TAP4084PD

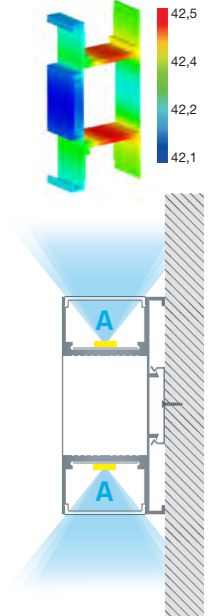
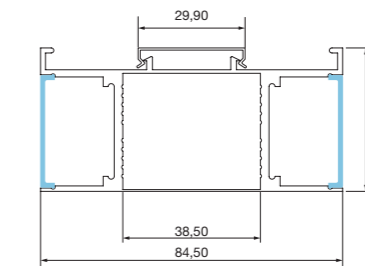



- ⚡ 19,2W/m máx.
- ⊗ 30,7 mm máx.
- 📏 1216 g/m
- 🔧 IK08

Medidas en milímetros / Medidas em milímetros

OKOA

PRO PF0430TBAN  Suspensión, difusor circular Ø=30 mm / Superficie, difusor circular, Ø=30 mm



-  19,2W/m máx.
-  19,6 mm máx.
-  238 g/m
-  IK08

• Tapas (incl.) Ref.:
TAPF0430TB

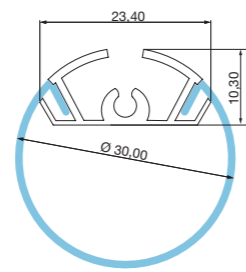

• Accesorios



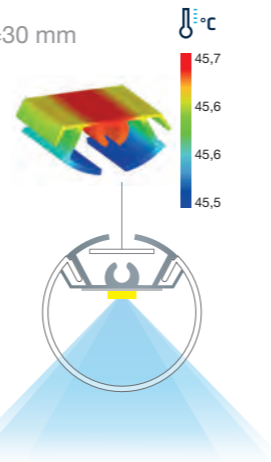

-  **APF5001** (1 m)
-  **APF5000** (2 m)
-  **APF5013** (3 m)
-  **APF5005**
-  **APF5007**
-  **APF5008**
-  **APF5009**

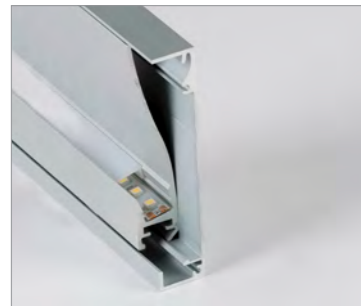

GANGES

PRO PF8016RDAN  Rodapie / Rodapés



-  19,2W/m máx.
-  10,1 mm máx.
-  1016 g/m
-  IK08

• Tapas (incl.) Ref.:
TAPF8016RD

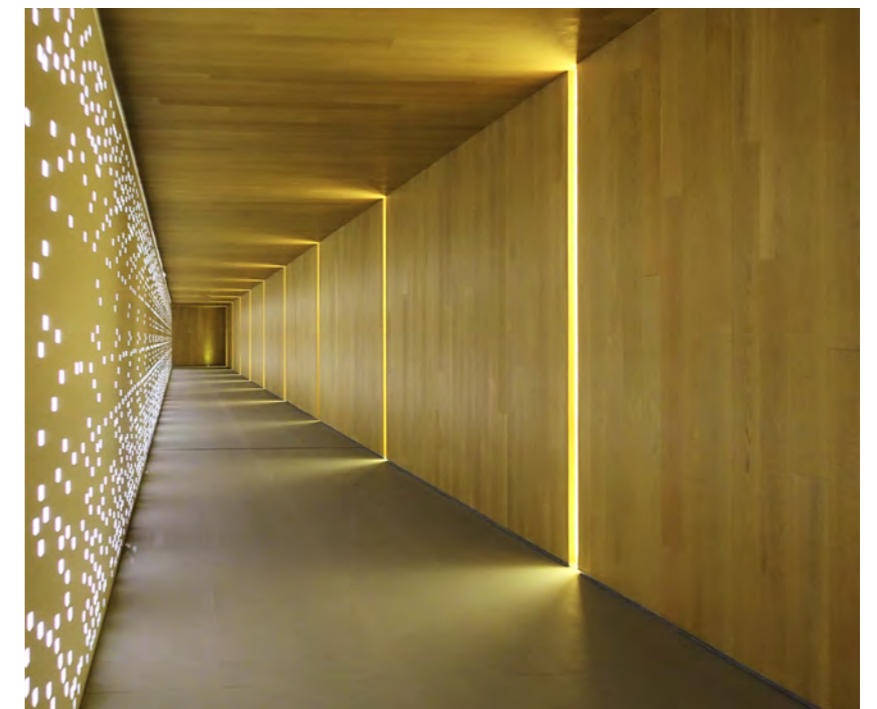
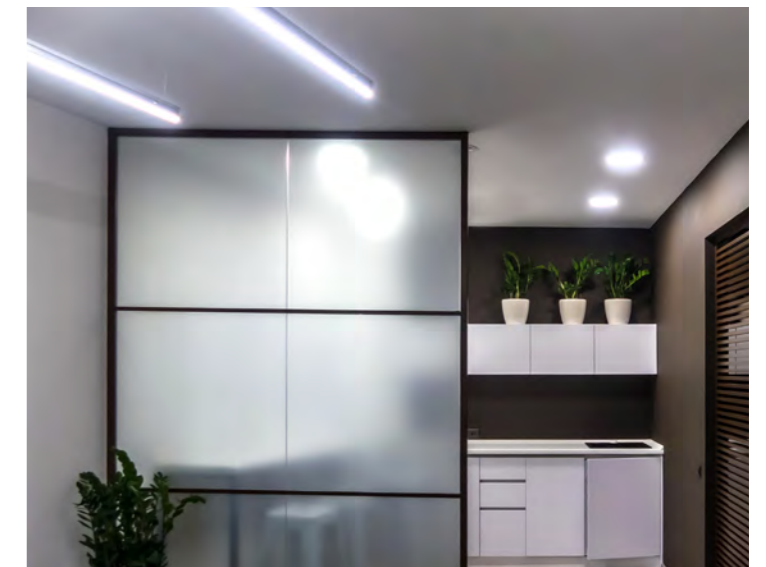
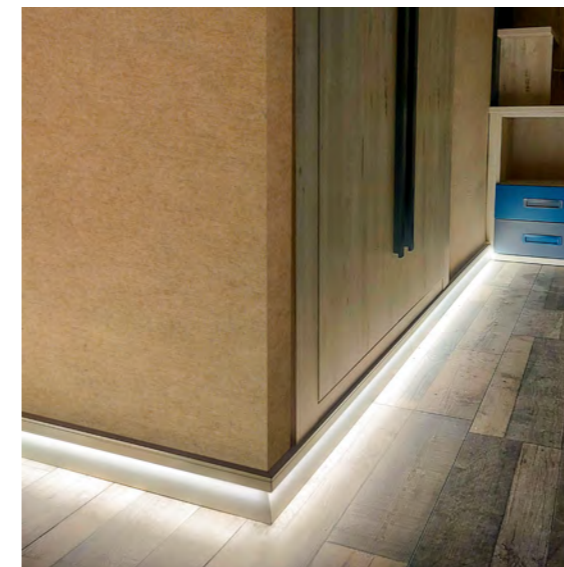
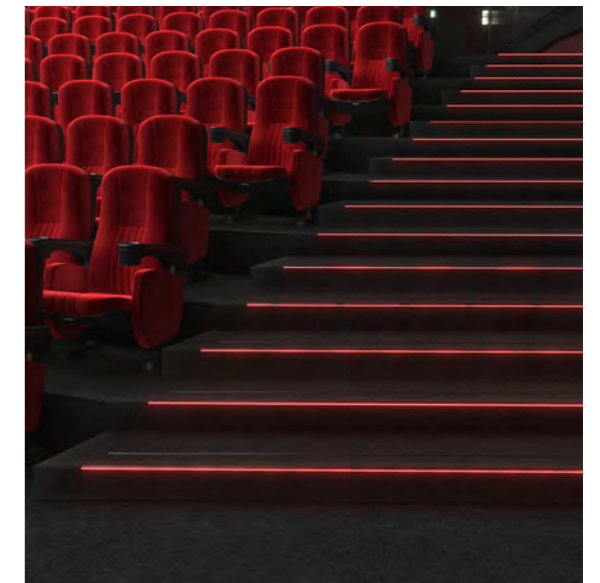
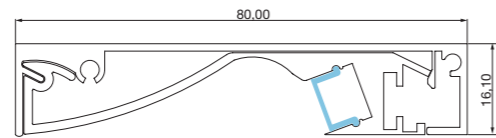

Medidas en milímetros / Medidas em milímetros

DAO

PRO PF1503CHAN Chapa disipadora / Chapa dissipadora

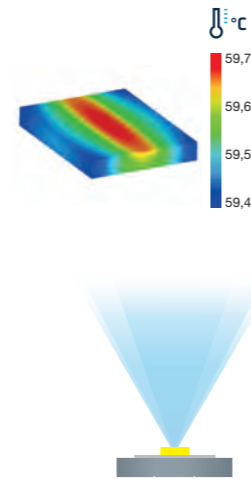
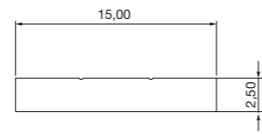
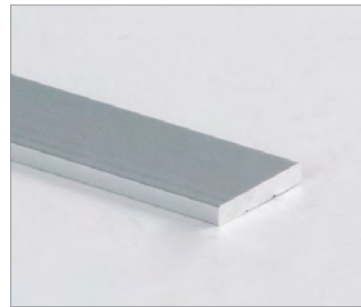

- 19,2W/m máx.
- 15 mm máx.
- 100 g/m
- IK08

DAO

PRO PF1508CHAN Chapa disipadora para esquina / Chapa dissipadora para canto

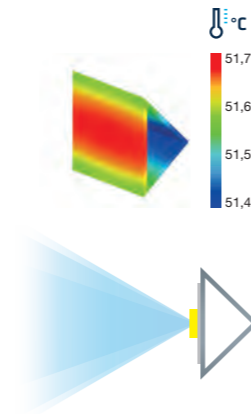
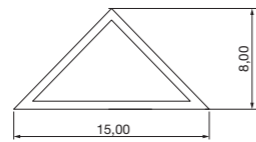
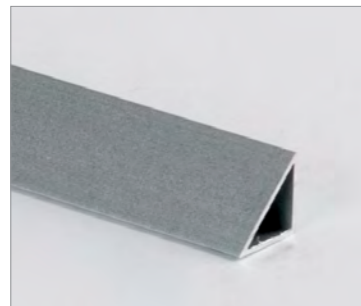

- 19,2W/m máx.
- 14,6 mm máx.
- 50 g/m
- IK08

DAO

PRO PF1515CHAN Chapa disipadora para esquina, en L / Chapa dissipadora para canto, en L

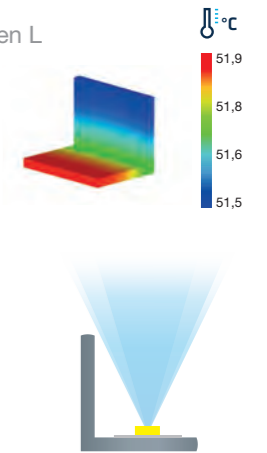
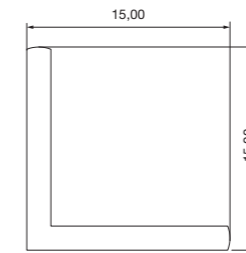
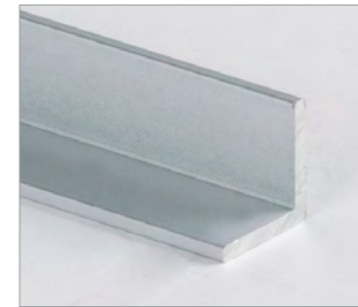

- 19,2W/m máx.
- 15 mm máx.
- 150 g/m
- IK08

DAO

PRO PF1235CHAN Chapa disipadora para esquina, en L / Chapa dissipadora para canto, en L

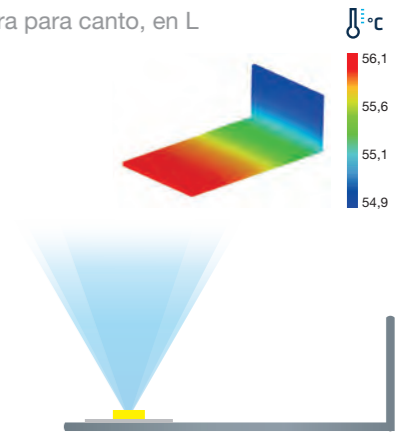
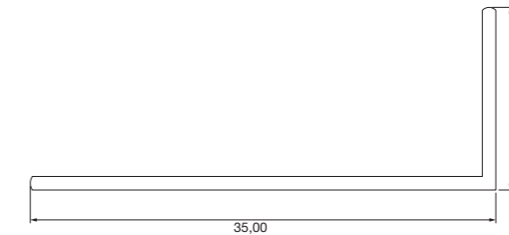
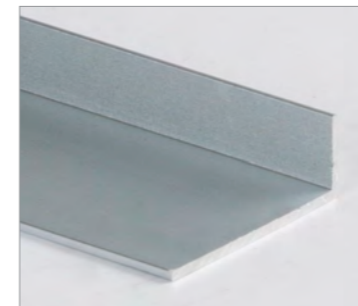

- 19,2W/m máx.
- 35 mm máx.
- 162 g/m
- IK08

ACCESORIOS PERFILES / ACESSÓRIOS PERFIS

EMPOTRAR / ENCASTRAR

APF5002



Pinza especial. Fácil colocación.
68x45x1,6 mm.

Pinça especial. Fácil colocação.
68x45x1,6 mm.

APF5004

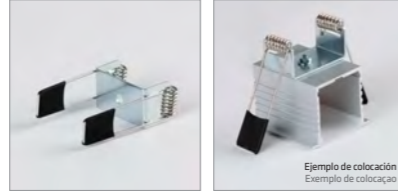

Pinza especial con tornillo.
63x48x1,2 mm.

Pinça especial com parafuso.
3x48x1,2 mm.

APF5006



Pinza para perfiles anchos.
54x51x8 mm.

Ref. de la pinza unitaria, pedir 2 uds.

Pinça para perfis largos.
54x51x8 mm.

Ref. da pinça unitária, pedir 2 uni.

APF5017

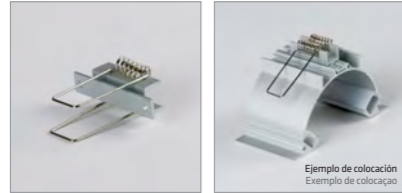

Pinzas para perfil PF10149EM.
45x45x1,6 mm.

Pinças, para perfil PF10149EM.
45x45x1,6 mm.

SUSPENSIÓN / SUSPENSÃO

APF5001



Cable acero, 1 metro.
Cabo de aço, 1 metro.

APF5000



Cable acero, 2 metros.
Cabo de aço, 2 metros.

APF5013



Cable acero, 3 metros.
Cabo de aço, 3 metros.

SUJECIÓN / FIXAÇÃO

APF5003



Pinza de fácil colocación.
61x58x1,4 mm.

Ref. de la pinza unitaria, pedir 2 uds.

Pinça de fácil colocação.
61x58x1,4 mm.

Ref. da pinça unitária, pedir 2 uni.

APF5007



Accesorio de unión/sujeción recto.
95x9mm.

Acessório de união/fixação recto.
95x9mm.

ACCESORIOS PERFILES / ACESSÓRIOS PERFIS

UNIÓN / UNIÃO

APF5005

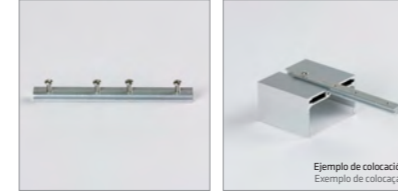

Accesorio de unión recto.
99x10x5,5 mm.

Acessório de união recto.
99x10x5,5 mm.

APF5008



Accesorio de unión plano 'L'.
50x50x1,6 mm.

Acessório de união em plano 'L'.
50x50x1,6 mm.

APF5009



Accesorio de unión 'L'.
49x49x1,7 mm.

Acessório de união "L".
49x49x1,7 mm.

APF5014



Accesorio de unión en esquina para
perfil PF1615EQ. 46x46x2 mm.

Acessório de união em canto para
perfil PF1615EQ. 46x46x2 mm.

APF5015



Accesorio de unión en esquina
para perfil PF1708SP. 46x46x1,3 mm.

Acessório de união em canto
para perfil PF1708SP. 46x46x1,3 mm.

DIFUSORES / DIFUSORES

DFP1122C1M

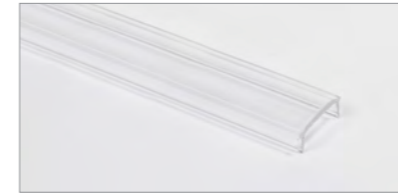

Metro de difusor transparente.
Ancho 12,5 mm.

Metro de difusor transparente.
Largura 12,5 mm.

DFP1322C1M

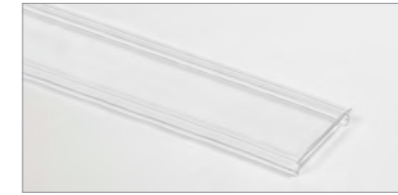

Metro de difusor transparente.
Ancho 32 mm.

Metro de difusor transparente.
Largura 32 mm.



Metro de difusor color. Ancho 12,5 mm.





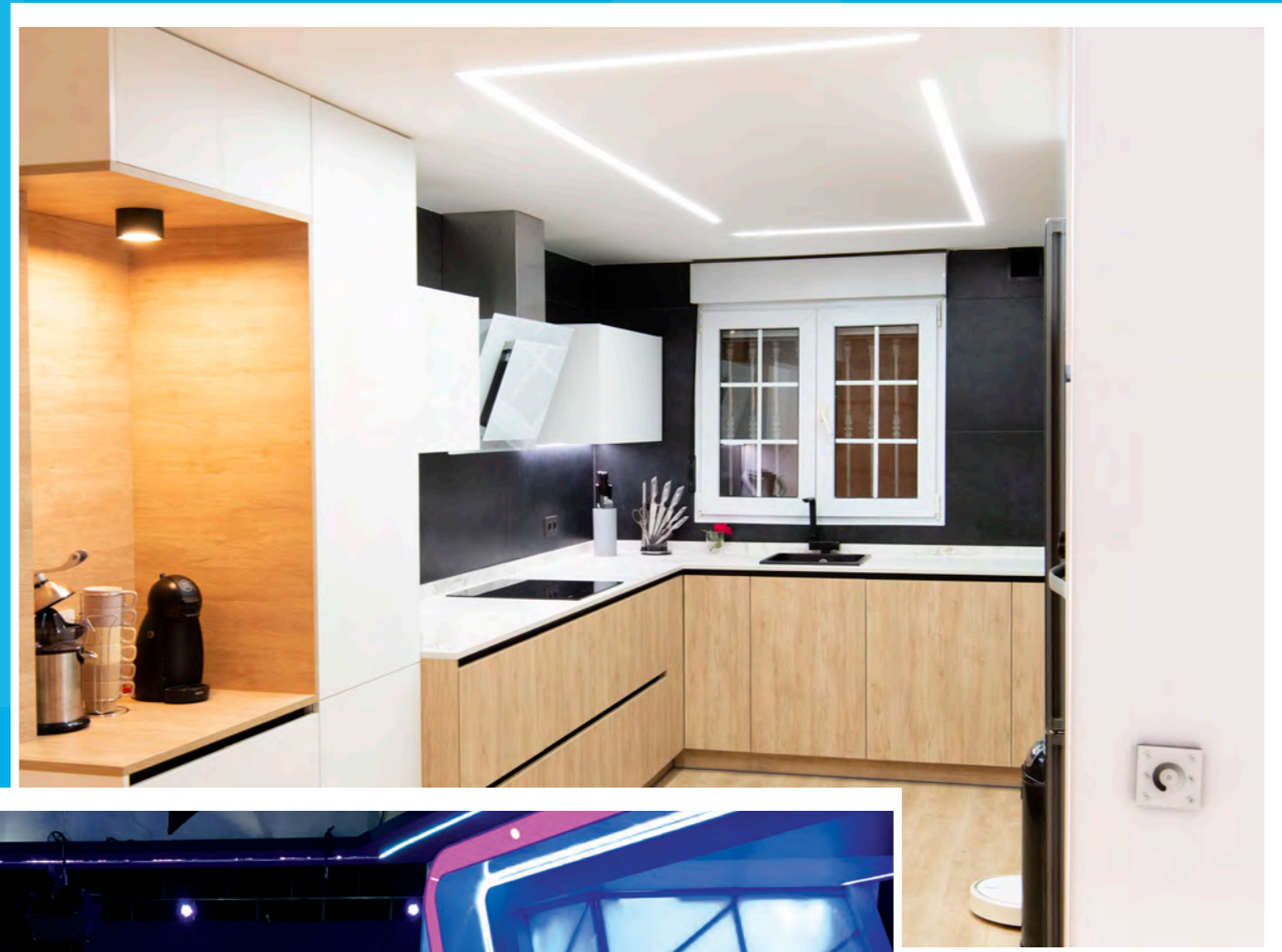







Metro de difusor cor. Largura 12,5 mm.

- DFP01127VEC1M
- DFP01124ROC1M
- DFP01123NEC1M
- DFP01126AZC1M
- DFP01125NAC1M



ELECTRONICA





CONTROLADORES



	CORTE DE FASE	DIGITAL	0/1-10V	DALI	TÁCTIL PARED TÁCTIL	TÁCTIL PARED MULTIZONA TÁCTIL
TIRAS LED 24Vcc			 TDIM12A Pág. 268	 CRTDAW Pág. 269	 4TW Pág. 270	
				 CRTDARGBI Pág. 269	 4TBI Pág. 270	
				 CRTDARGB+W Pág. 269	 4TRGB Pág. 270	
				 CRTDARGB+W Pág. 269	 4TRGB+W Pág. 270	 4TDX8 DX8RF Pág. 271
TIRAS LED 230Vac	 PCD240W Pág. 266					
TIRAS LED DIGITALES		 CTRXD Pág. 267				

TIRAS LED

TÁCTIL PARED + MANDO RF TÁCTIL + RF	MANDO RF	MANDO MULTIZONA RF	DMX	CASAMBI BLUETOOTH	SMART HOME WIFI	AMPLIFICADORES
 4TRTW Pág. 272	 RTW Pág. 273	 RTMZWB R3MWBI Pág. 274	 CTRSCNRGB CTRDECDMX Page 275	 CSB1224DC Pág. 276	 SMART-CRT Pág. 277	 AMPLEDW Pág. 286
 4TRTBI Pág. 272	 RTBI Pág. 273	 RTMZBI R3MWBI Pág. 274	 CTRSCNRGB CTRDECDMX Page 275	 CSB1224DC Pág. 276	 SMART-CRT Pág. 277	 AMPLEDBI Pág. 286
 4TRTRGB Pág. 272	 RTRGB Pág. 273	 RTMZRGBW R4MRGBW Pág. 274	 CTRSCNRGB CTRDECDMX Page 275	 CSB1224DC Pág. 276	 SMART-CRT Pág. 277	 AMPLEDRGBN Pág. 286
	 CTRLEDRGB Pág. 273					 AMPLEDRGB Pág. 286
 4TRTRGB+W Pág. 272	 RTRGB+W Pág. 273	 RTMZRGBW R4MRGBW Pág. 274	 CTRD MXRGB+W Pág. 275	 CSB1224DC Pág. 276	 SMART-CRT Pág. 277	 AMPLEDRGB+W AMPLEDR Pág. 286

LUMINARIAS

	TRIAC	PARED	TÁCTIL PARED TÁCTIL	TÁCTIL PARED + MANDO RF TÁCTIL + RF
LUMINARIAS 0/1-10V		 DIM110VRLT Pág. 279	 DIM110V4T Pág. 279	 DIM110VRLRTR Pág. 279
LUMINARIAS TRIAC	 PCD240W Pág. 278			

MANDO RF	MANDO MULTIZONA RF
 MDRF + MDRF1 Pág. 279	 DIM110VRT Pág. 278
	 MDRF + MDRF4 Pág. 280

CONTROLADORES TIRAS LED / CONTROLADORES FITAS LED

☺ CORTE DE FASE / CORTE DE FASE

PCD240W

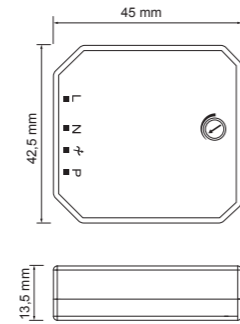

INSTALACIÓN / INSTALAÇÃO

Instalación 1 pulsador

Instalação 1 botão

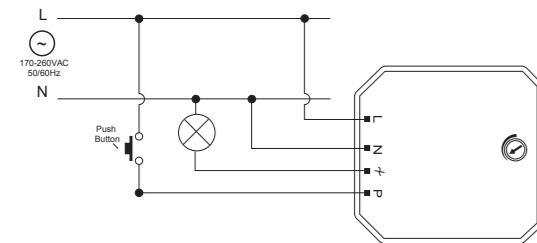

Instalación 2 o más pulsadores

Instalação 2 ou mais botões

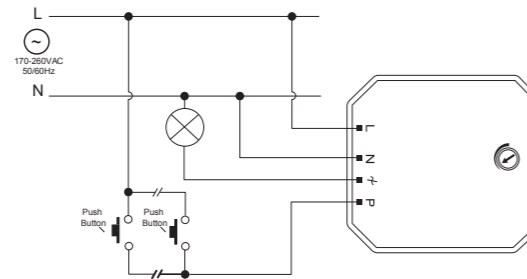

INCLUYE / INCLUI

1. POTENCIÓMETRO

Permite ajustar la regulación según el tipo de carga, evitando así el parpadeo en el mínimo.

Permite ajustar a regulação de acordo com o tipo de carga, evitando a cintilação no mínimo.

2. LAMP MEMORY

Permite activar y desactivar la memoria para que actúe tras el apagado del interruptor. Al accionar el interruptor, si la memoria se encuentra en la posición ON, las lámparas volverán al último estado antes de apagarse; si la memoria está en OFF, las lámparas se encenderán al 100%.

Permite ativar e desativar a memória para agir após o desligar o interruptor. Quando ligar o interruptor, se o a memória está na posição ON, as lâmpadas retornam para o último estado antes desligar; se a memória estiver em modo OFF, as lâmpadas acenderão a 100%.

3. POWER MEMORY

Permite activar y desactivar la memoria para que actúe tras un corte en el suministro de la red eléctrica. Al reactivarse el suministro, si se encuentra en la posición ON, las lámparas volverán al último estado antes del corte, si está en OFF las lámparas permanecerán apagadas tras la vuelta del suministro.

Permite ativar e desativar a memória para agir após um corte no fornecimento de energia elétrica. Ao reativar o fornecimento, caso esteja na posição ON, as lâmpadas retornam até o último estado antes do corte; se estiver em modo OFF, as lâmpadas permanecerão desligadas após reposto o fornecimento de energia.

CONTROLADORES TIRAS LED / CONTROLADORES FITAS LED

☺ DIGITAL

CTRXD



Controlador para tiras digitales.

Controlador para fitas digitais.

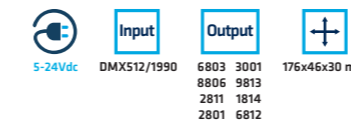

CONTROLADORES TIRAS LED / CONTROLADORES FITAS LED

0/1-10V

TDIM12A



12-24Vdc 12Ax1Ch 144W (12V) 288W (24V) -30° - 55° C 175x44x30 mm 0/1-10V

ESQUEMA DE CONEXIÓN / ESQUEMA DE LIGAÇÃO

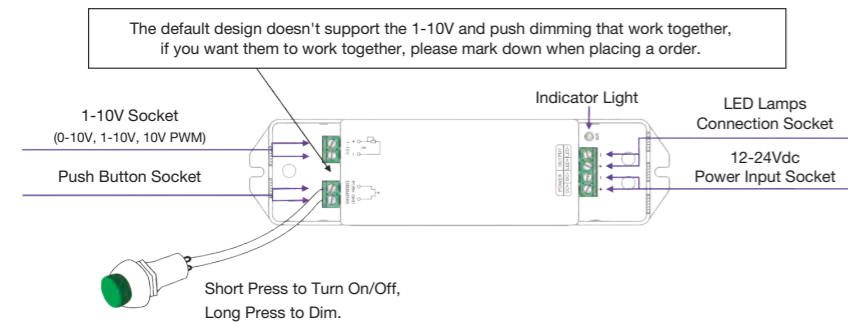

CONTROLADORES TIRAS LED / CONTROLADORES FITAS LED

DALI

CRTDAW



12-24Vdc 10Ax1Ch 120W (12V) 240W (24V) -20° a 50° C 176x46x30 mm DALI

CRTDARGBI



12-24Vdc 5Ax3Ch 180W (12V) 360W (24V) -20° a 50° C 176x46x30 mm DALI

CRTDARGB+W



12-24Vdc RGB: 3Ax3Ch W: 9Ax1Ch RGB: 36Wx3Ch / W: 108W (12V) RGB: 72Wx3Ch / W: 216W (24V) -20° a 50° C 176x46x30 mm DALI

ESQUEMA DE CONEXIÓN / ESQUEMA DE LIGAÇÃO

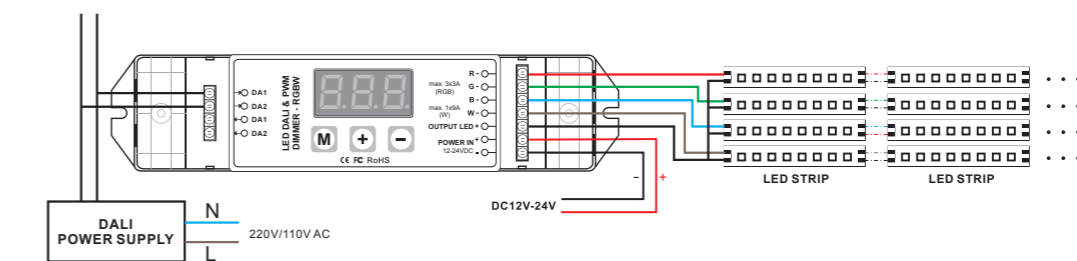

CONTROLADORES TIRAS LED / CONTROLADORES FITAS LED

TÁCTIL PARED / TÁCTEIS PAREDE

4TW



- 12-24Vdc
- CH 4Ax4Ch 192W (12V) 16A(máx)
- W 384W (24V)
- 20° - +55° C
- 86x86x36 mm

4TBI



- 12-24Vdc
- CH 4Ax4Ch 192W (12V) 16A(máx)
- W 384W (24V)
- 20° - +55° C
- 86x86x36 mm

4TRGB



- 12-24Vdc
- CH 4Ax3Ch 144W (12V) 12A(máx)
- W 288W (24V)
- 20° - +55° C
- 86x86x36 mm

4TRGB+W



- 12-24Vdc
- CH 4Ax4Ch 192W (12V) 16A(máx)
- W 384W (24V)
- 20° - +55° C
- 86x86x36 mm

CONTROLADORES TIRAS LED / CONTROLADORES FITAS LED

TÁCTIL PARED MULTIZONA / TÁCTEIS PAREDE MULTIZONA

4TDX8 / DX8RF



- 110-240Vac 50/60Hz
- CH RF 2.4G + DMX512
- 30° - +55° C
- 86x86x36 mm
- 12-24Vdc
- CH 5Ax4Ch 240W (12V) 20A(máx)
- W 480W (24V)
- 30° a 50° C
- 44x175x30 mm

ESQUEMA DE CONEXIÓN / LIGAÇÃO

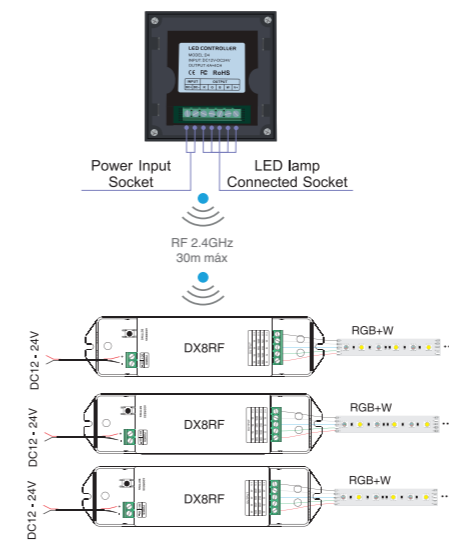

*Batería (CR2032) no incluida en el mando. *Bateria (CR2032) não incluída no comando.

CONTROLADORES TIRAS LED / CONTROLADORES FITAS LED

TÁCTIL PARED + RF / TÁCTEIS PAREDE + RF

4TRTW



4TRTBI



4TRTRGB



4TRTRGB+W



ESQUEMA DE CONEXIÓN / ESQUEMA DE LIGAÇÃO

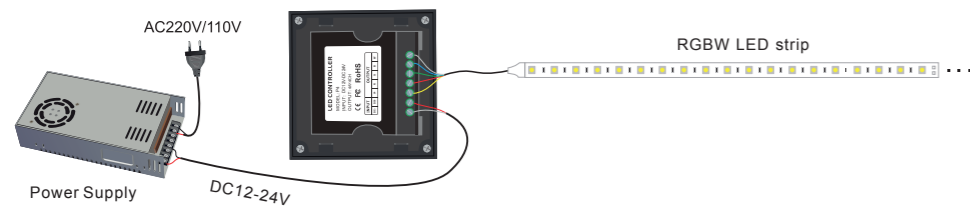

CONTROLADORES TIRAS LED / CONTROLADORES FITAS LED

RF (RADIOFRECUENCIA) / RF (RADIOFREQUÊNCIA)

RTW

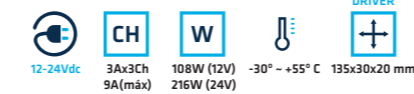

RTBI



RTRGB

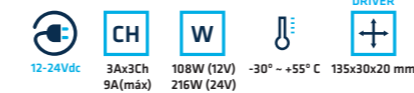

CTRLEDRGB



RTRGB+W

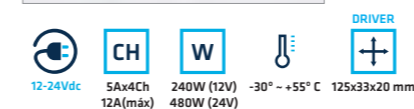

ESQUEMA DE CONEXIÓN / ESQUEMA DE LIGAÇÃO

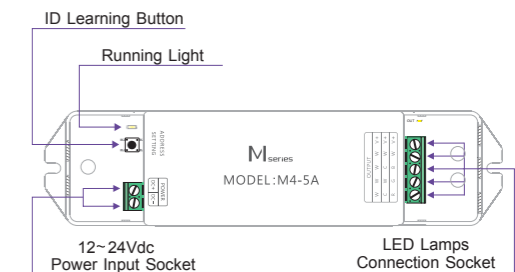

*Batería (CR2032) no incluida en el mando / *Bateria (CR2032) não incluída no comando

CONTROLADORES TIRAS LED / CONTROLADORES FITAS LED

RF MULTIZONA / RF MULTIZONA

RTMZW



Receptor: R3MWBI

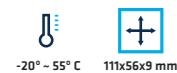

-20° ~ +55° C 111x56x9 mm

RTMZBI



Receptor: R3MWBI



-20° ~ +55° C 111x56x9 mm

RTMZRGBW



Receptor: R4MRGBW

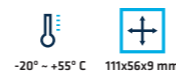

-20° ~ +55° C 111x56x9 mm

R3MWBI

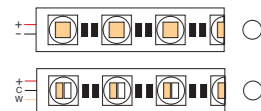

1 x Zona

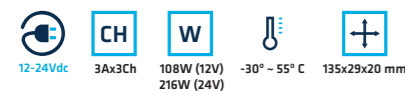

12-24Vdc 3Ax3Ch 108W (12V) 216W (24V) -30° ~ +55° C 135x29x20 mm

R4MRGBW



1 x Zona

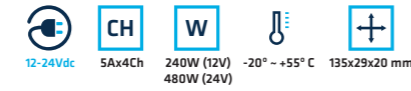

12-24Vdc 5Ax4Ch 240W (12V) 480W (24V) -20° ~ +55° C 135x29x20 mm

ESQUEMA DE CONEXIÓN / ESQUEMA DE LIGAÇÃO

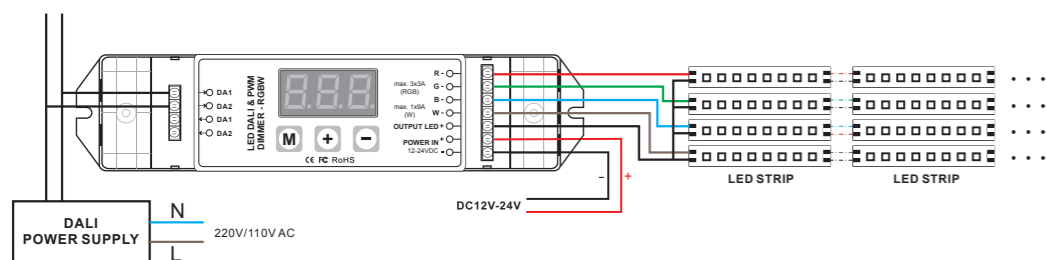

*Batería (CR2032) no incluida en el mando. *Bateria (CR2032) não incluída no comando.

CONTROLADORES TIRAS LED / CONTROLADORES FITAS LED

DMX

CTRSCNRGB

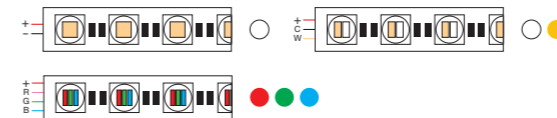

5-24Vdc 6Ax3Ch 220W (12V) 432W (24V) -20° ~ +50° C 142x88x30 mm DMX 512/1990 16 niveles x canal escala (256 niveles por canal)

CTRDECDMX

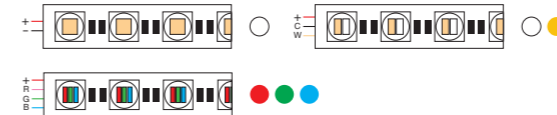

5-24Vdc 8Ax3Ch 120W (5V) 288W (12V) 576W (24V) DMX512/1990 3Ch voltaje constante PWM



3Ch XLR-3 estándar 256 -30° ~ +65° C 156x78x40 mm

CTRDMXRGB+W



5-24Vdc RGB: 3Ax3Ch W: 9Ax1Ch RGB: 36Wx3Ch (12V) W: 108W (12V) DMX512/1990 RGB: 72Wx3Ch (24V) W: 216W (24V)



4Ch voltaje constante PWM 4Ch XLR-3 estándar 256 176x46x30 mm

ESQUEMA DE CONEXIÓN DMX / ESQUEMA DE LIGAÇÃO DMX

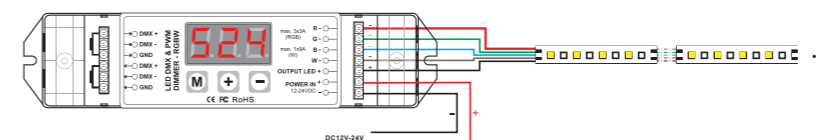

CONTROLADORES TIRAS LED / CONTROLADORES FITAS LED

BLUETOOTH CASAMBI

CSB1224DC

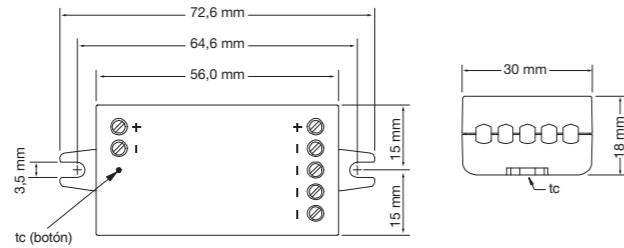
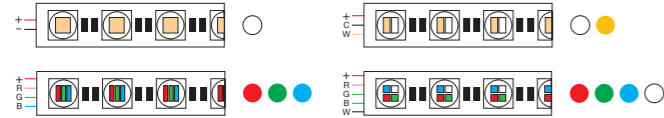

- 12-24Vdc
- CH 4Ch 6A (max)
- Wout 72W (12V) 144W (24V)
- 30 m
- 50 m
- 20°~+45° C

ESQUEMA DE CONEXIÓN / ESQUEMA DE LIGAÇÃO

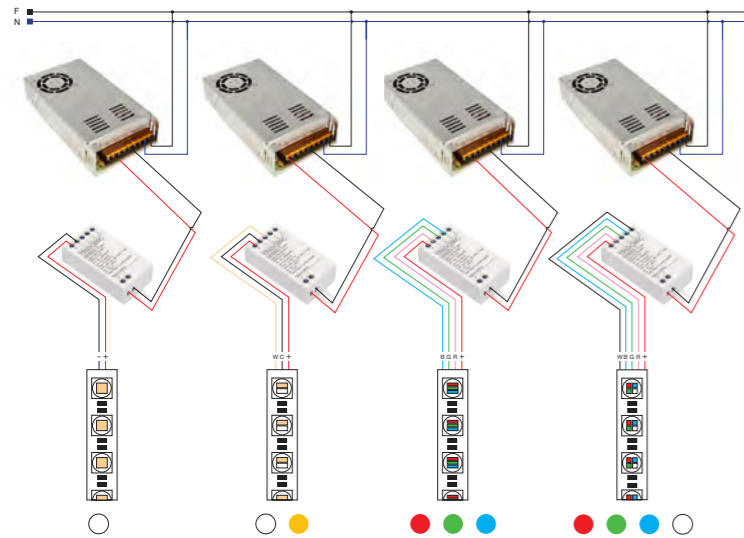

Wiring diagram, RGBW

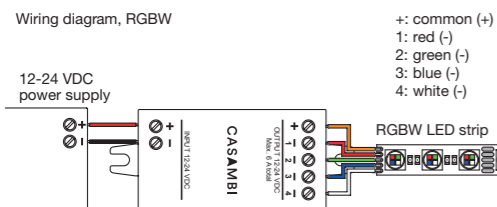

- +: common (+)
- 1: red (-)
- 2: green (-)
- 3: blue (-)
- 4: white (-)

CONTROLADORES TIRAS LED / CONTROLADORES FITAS LED

WIFI SMART HOME



SMART-CRT

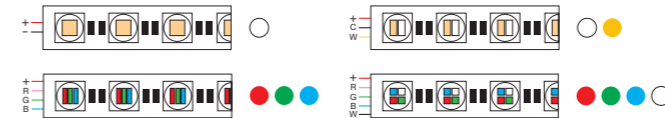

Compatibilidad con asistentes de voz y aplicaciones:

Compatibilidade com sistentes por voz e aplicações:

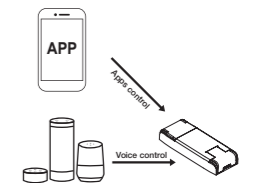
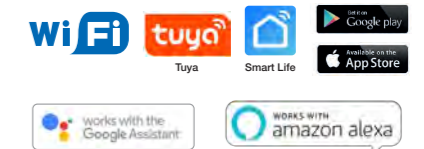

- 12-24Vdc
- W 96W (12V) 192W (24V)
- Vout 12V/24V 8A Max
- F 2,4-2,4835 GHz
- 20°~+50° C
- 115x45x18 mm

ESQUEMA DE CONEXIÓN / ESQUEMA DE LIGAÇÃO

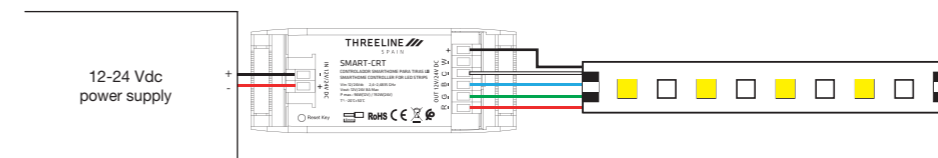

CONTROLADORES LUMINARIAS / CONTROLADORES LUMINÁRIAS

0/1-10V / CORTE DE FASE / CORTE DE FASE

PCD240W

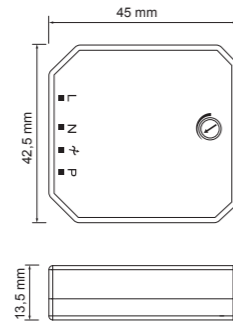

0/1-10V / PARED / PAREDE

DIM110VRLT

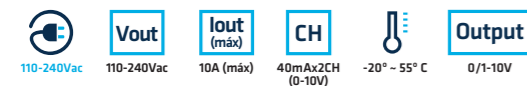

PARED TÁCTIL / PAREDE TACTÉIS

DIM110V4T

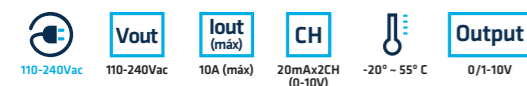

PARED + RF / PAREDE + RF

DIM110VRLTRT



RF / RF

DIM110VRT



CONTROLADORES LUMINARIAS / CONTROLADORES LUMINÁRIAS

0/1-10V

RF / RF

MDRF



RF / RF

MDMRF1



ESQUEMA DE CONEXIÓN / ESQUEMA DE LIGAÇÃO

UNA LUMINARIA / UMA LUMINARIA

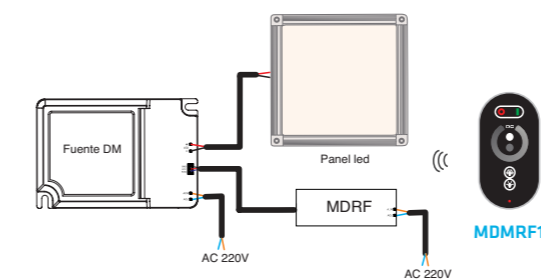

HASTA 20 LUMINARIAS / ATÉ 20 LUMINÁRIAS

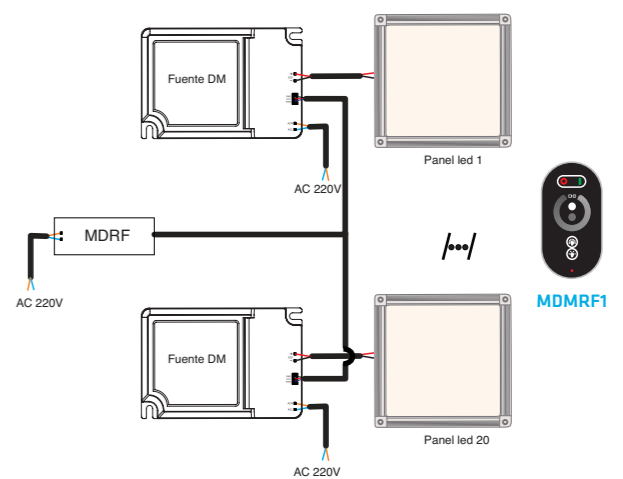

Alimentar el módulo (MDRF) y conectar su salida 0-10 V a la entrada 0-10 V de cada una de las fuentes de alimentación DM.
Alimentar o módulo (MDRT) e ligar a saída 1/10V à entrada 0/10V a cada uma das fontes de alimentação DM.

CONTROLADORES LUMINARIAS / CONTROLADORES LUMINÁRIAS

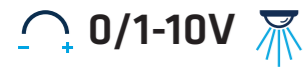

RF MULTIZONA / RF MULTIZONA

MDRF



RF MULTIZONA / RF MULTIZONA

MDMRF4



ESQUEMA DE CONEXIÓN / ESQUEMA DE LIGAÇÃO

HASTA 20 LUMINARIAS POR ZONA / ATÉ 20 LUMINÁRIAS POR ZONA

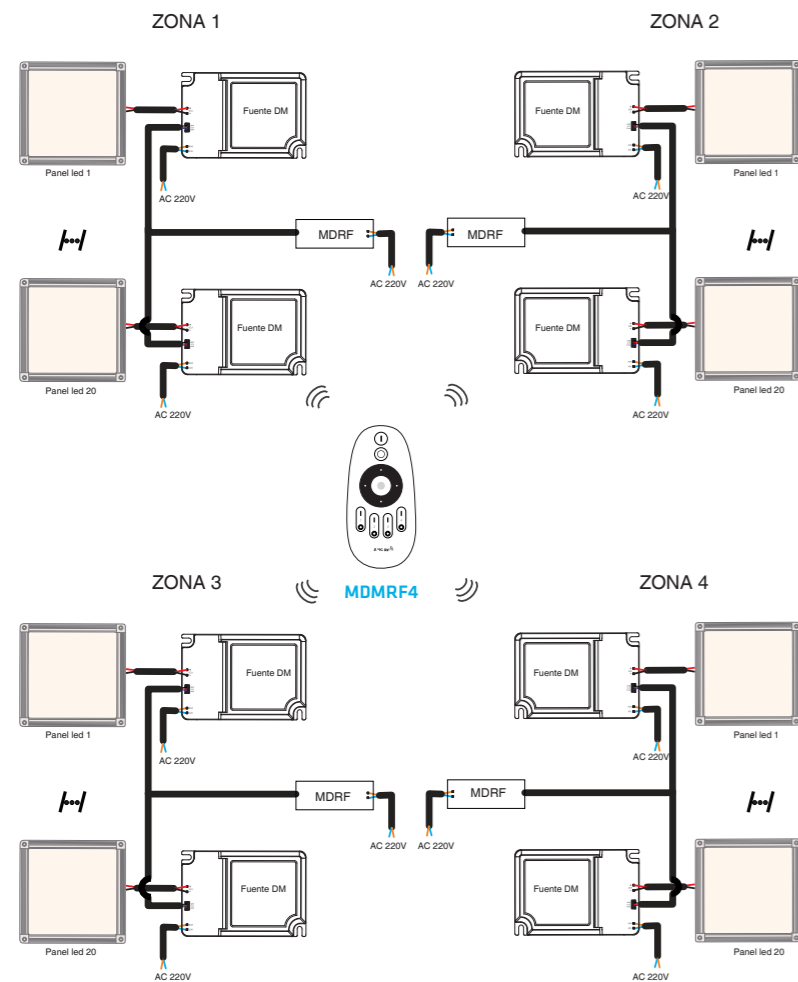

Alimentar el módulo (MDRF) y conectar su salida 0-10V a la entrada 0-10V de cada una de las fuentes de alimentación DM.

Alimentar o módulo (MDRT) e ligar a saída 0-10V à entrada 0-10V a cada uma das fontes de alimentação DM.

CONTROLADORES LUMINARIAS / CONTROLADORES LUMINÁRIAS



PARED TÁCTIL / PAREDE TACTÉIS

DALI_TPBC_C

Controlador pared táctil para sistema DALI / controlador de parede táctil para sistema DALI



Interface: DALI
1 Grupo - 3 Escenas

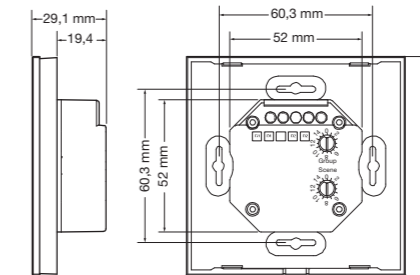

PASARELAS / GATEWAY

PASARELAS				
DE \ A	TRIAC	DALI	0/1-10V	PWM
DALI	DALI_RDG2 Pág. 283		PDALID110 Pág. 283	DALI-PWM Pág. 285
CASAMBI	CSBTRIAC Pág. 283	CSB110DA Pág. 284	CSB110DA Pág. 284	
PUSH		DALIXC Pág. 284		
ZIGBEE			ZIGBEE-010V Pág. 285	
DMX			PDMX110 Pág. 284	

PASARELAS / GATEWAY

DALI → TRIAC

DALI_RDG2

Pasarela DALI - Corte de fase / Passarela DALI - Corte de fase

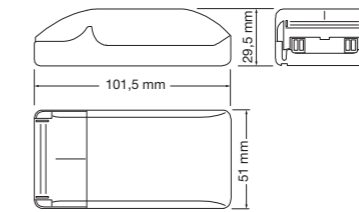

220-240Vac
 50/60Hz
 P (máx) 300VA
 Input DALI
 CH OUT 1 TRIAC
 0° - 50° C

CASAMBI → TRIAC

CSBTRIAC

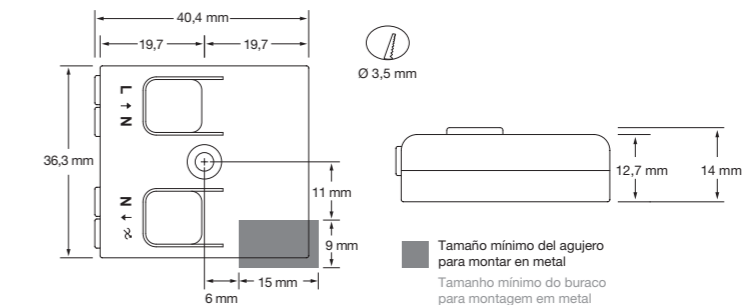

85-240Vac
 50/60Hz
 I_{in} (máx) 0,65A
 W_{out} (máx) 150 VA (230Vac) 75 VA (110Vac)
 Input TRIAC
 OUTPUT
 -20° - +45° C

DALI → 0/1-10V

PDALID110

Pasarela DALI - 0-10V / Passarela DALI - 0-10V

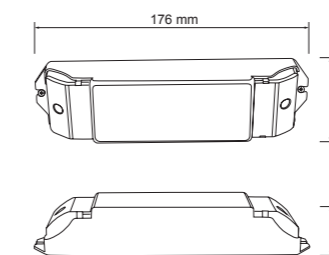

110-240Vac
 Input DALI
 Output 0-10Vx4CH
 I_{out} (máx) 20mAx4CH

PASARELAS / GATEWAY

CASAMBI → DALI - 0/1-10V

CSB110DA

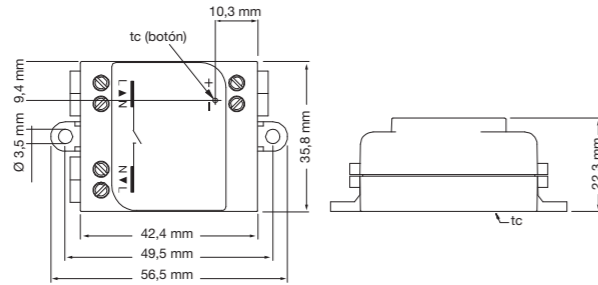

*Para potencias mayores hacer la conexión a través de un relé.
*Para potências superiores, fazer a ligação através de um relé.

PULSADOR TRADICIONAL → DALI

DALIXC

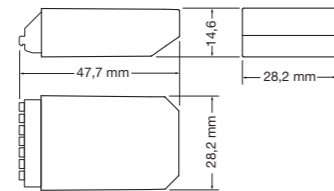

DMX → 0/1-10V

PDMX110

Pasarela DMX - 0-10V / Passarela DMX - 0-10V

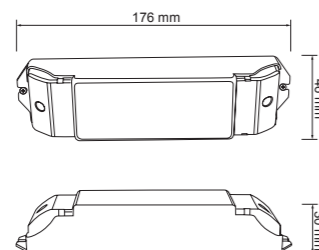

PASARELAS / GATEWAY

ZIGBEE → 0/1-10V

ZIGBEE-010V

Pasarela ZIGBEE - 0/1-10V / Gateway DALI - 0/1-10V

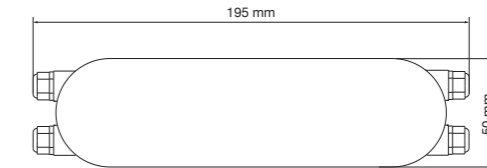

Señal de entrada: ZIGBEE / Señal de salida: 0/1-10V
Señal de entrada: ZIGBEE / Señal de salida: 0/1-10V

DALI → PWM

DALI-PWM

Pasarela DALI - PWM / Pasarela DALI - PWM

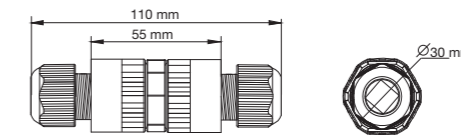

Señal de entrada: DALI / Señal de salida: PWM
Señal de entrada: DALI / Señal de salida: PWM

AMPLIFICADORES TIRAS LED / AMPLIFICADORES FITAS LED

AMPLEDW

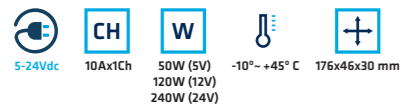

AMPLEDBI



AMPLEDRGBN

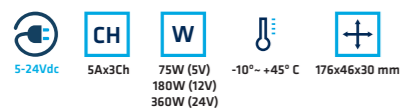

AMPLEDRGB



AMPLEDRGB+W

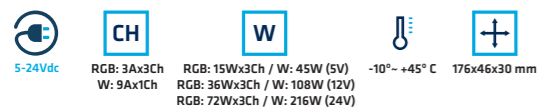

AMPLEDRT



AMPLIFICADORES DALI / AMPLIFICADORES DALI

R_DALI

Amplificador de señal DALI / Amplificador de sinal DALI
Amplificador de señal: 300-600 m / Amplificador de sinal: 300-600 m

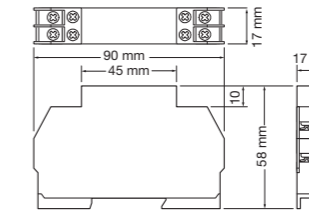

FUENTES Vcte / FONTES Vcte REJILLA / REDE

VLED24R35W



110-240Vac
 50/60Hz
 24Vdc
 1,5A (máx)
 35W
 $\cos \phi > 0,9$
 100x82x30 mm
 IP20

VLED24R60W



110-240Vac
 50/60Hz
 24Vdc
 2,5A (máx)
 60W
 $\cos \phi > 0,9$
 100x82x30 mm
 IP20

VLED24R100W



110-240Vac
 50/60Hz
 24Vdc
 4,5A (máx)
 100W
 $\cos \phi > 0,9$
 125x95x30 mm
 IP20

VLED24R150W



110-240Vac
 50/60Hz
 24Vdc
 6,5A (máx)
 150W
 $\cos \phi > 0,9$
 159x97x30 mm
 IP20

VLED24R250W



110-240Vac
 50/60Hz
 24Vdc
 10A (máx)
 250W
 $\cos \phi > 0,9$
 215x115x30 mm
 IP20

VLED24R350W



110-240Vac
 50/60Hz
 24Vdc
 350W
 14,6A (máx)
 $\cos \phi > 0,9$
 215x115x30 mm
 IP20

VLED24R400W



110-240Vac
 50/60Hz
 24Vdc
 400W
 16,5A (máx)
 $\cos \phi > 0,9$
 215x115x30 mm
 IP20

FUENTES Vcte / FONTES Vcte ESTANCAS / ESTANQUES

VLED24-E30W



110-240Vac
 50/60Hz
 24Vdc
 1,25A (máx)
 30W
 $\cos \phi > 0,9$
 222x29x20 mm
 IP66

VLED24-E60W



110-240Vac
 50/60Hz
 24Vdc
 2,5A (máx)
 60W
 $\cos \phi > 0,9$
 180x70x40 mm
 IP66

VLED24-E100W



110-240Vac
 50/60Hz
 24Vdc
 4,5A (máx)
 100W
 $\cos \phi > 0,9$
 185x70x45 mm
 IP66

VLED24-E150W



110-240Vac
 50/60Hz
 24Vdc
 6,5A (máx)
 150W
 $\cos \phi > 0,9$
 235x120x50 mm
 IP66

VLED24-E250W



110-240Vac
 50/60Hz
 24Vdc
 10A (máx)
 250W
 $\cos \phi > 0,9$
 235x120x50 mm
 IP66

FUENTES Vcte / FONTES Vcte COMPACTAS / COMPACTAS

DTC24-30W



220-240Vac 50/60Hz 24Vdc 1,25A (máx) 30W $\cos \phi > 0,9$ IP20

DTC24-60W



220-240Vac 50/60Hz 24Vdc 2,5A (máx) 60W $\cos \phi > 0,9$ IP20

DTC24-75W



220-240Vac 50/60Hz 24Vdc 3,13A (máx) 75W $\cos \phi > 0,9$ IP20

DTC24-120W



220-240Vac 50/60Hz 24Vdc 5A (máx) 120W $\cos \phi > 0,9$ IP20

DTC24-150W



220-240Vac 50/60Hz 24Vdc 6,25A (máx) 150W $\cos \phi > 0,9$ IP20

FUENTES Vcte / FONTES Vcte SLIM

DTLIN24-30W



220-240Vac 50/60Hz 24Vdc 1,25A (máx) 30W $\cos \phi > 0,9$ IP20

DTLIN24-60W



220-240Vac 50/60Hz 24Vdc 2,5A (máx) 60W $\cos \phi > 0,9$ IP20

DTLIN24-100W



220-240Vac 50/60Hz 24Vdc 4,17A (máx) 100W $\cos \phi > 0,9$ IP20

DTLIN24-160W



220-240Vac 50/60Hz 24Vdc 6,67A (máx) 160W $\cos \phi > 0,9$ IP20

FUENTES Icte / FONTES Icte

DM250-700mA



CONFIGURACIÓN DEL SWITCH CONFIGURAÇÃO DO SWITCH

Tensión nominal Tensão nominal	Potencia de entrada Potência de entrada	Corriente de salida Corrente de saída	1	2	3	4
84VDC	23 W	250mA	--	ON	ON	ON
84VDC	28 W	300mA	ON	--	ON	ON
84VDC	32 W	350mA	--	--	ON	ON
84VDC	37 W	400mA	--	ON	--	ON
84VDC	41 W	450mA	--	--	--	ON
84VDC	46 W	500mA	ON	ON	ON	--
76VDC	46 W	550mA	--	--	ON	--
70VDC	46 W	600mA	--	ON	--	--
64VDC	46 W	650mA	ON	--	--	--
60VDC	47 W	700mA	--	--	--	--

DM800-2000mA



CONFIGURACIÓN DEL SWITCH CONFIGURAÇÃO DO SWITCH

Tensión nominal Tensão nominal	Potencia de entrada Potência de entrada	Corriente de salida Corrente de saída	1	2	3	4	5	6
42VDC	37 W	800mA	ON	--	ON	--	ON	ON
42VDC	42 W	900mA	--	--	--	--	--	ON
42VDC	46 W	1000mA	ON	ON	ON	--	ON	--
42VDC	51 W	1100mA	--	ON	ON	--	ON	--
42VDC	54 W	1150mA	--	--	--	--	ON	--
42VDC	56 W	1200mA	--	ON	ON	ON	--	--
42VDC	58 W	1250mA	ON	--	ON	ON	--	--
42VDC	61 W	1300mA	--	--	ON	ON	--	--
42VDC	65 W	1400mA	--	ON	--	ON	--	--
40VDC	67 W	1500mA	--	--	--	ON	--	--
38VDC	68 W	1600mA	ON	ON	ON	--	--	--
36VDC	69 W	1700mA	--	--	ON	--	--	--
34VDC	69 W	1800mA	--	ON	--	--	--	--
32VDC	69 W	1900mA	ON	--	--	--	--	--
30VDC	69 W	2000mA	--	--	--	--	--	--

*No modificar el switch cuando está conectado / Não altere o switch enquanto estiver conectado.

FUENTES DALI / FONTES DALI

DALIPS1



Alimentación para equipos y módulos de control DALI sin alimentación propia
Fonte de alimentação para equipamentos e módulos de controlo DALI sem fonte de alimentação própria.

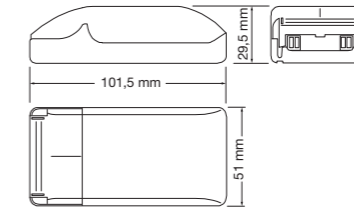

DALIPS2



Alimentación para equipos y módulos de control DALI sin alimentación propia. Para montaje en armario de conexiones.

Fonte de alimentação para equipamentos e módulos de controlo DALI sem fonte de alimentação própria. Para montagem em quadros eléctricos, em calha DIM.

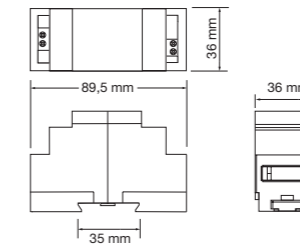

SENSORES / SENSORES

ON/OFF

SP20 Movimiento / Movimento

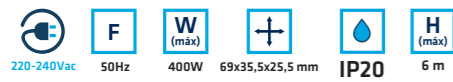
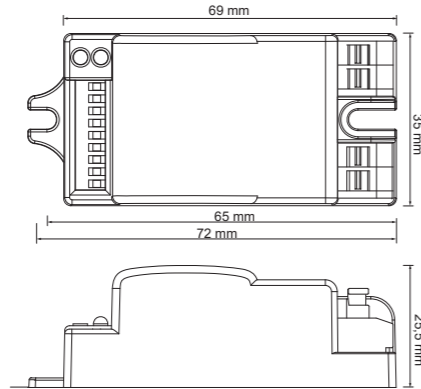

CONFIGURACIÓN DEL SWITCH / CONFIGURAÇÃO DO SWITCH

Detección de área / Detecção de área

		1	2	3
ON	100%	ON	ON	ON
	75%	-	ON	ON
	50%	ON	-	ON
	25%	-	-	ON
	10%	-	-	-

Tiempo de funcionamiento / Tempo de funcionamento

		4	5	6
ON	5 s	ON	ON	ON
	30 s	-	ON	ON
	90 s	ON	-	ON
	3 min	-	-	ON
	20 min	ON	ON	-
	30 min	-	-	-

Sensor de luz / Sensor de luz

		7	8	9
ON	2 lux	ON	ON	ON
	10 lux	ON	ON	-
	25 lux	-	ON	-
	50 lux	ON	-	-
	Disable	-	-	-

SP65V2 Movimiento / Movimento

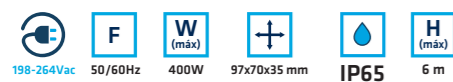
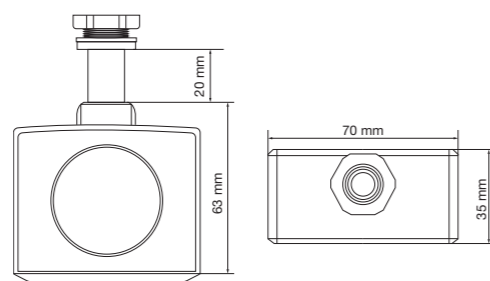

CONFIGURACIÓN DEL SWITCH / CONFIGURAÇÃO DO SWITCH

Detección de área / Detecção de área

		1	2
ON	100%	ON	ON
	75%	-	ON
	50%	ON	-
	25%	-	-

Tiempo de funcionamiento / Tempo de funcionamento

		3	4	5
ON	5 s	ON	ON	ON
	30 s	-	ON	ON
	90 s	ON	-	ON
	3 min	-	-	ON
	20 min	ON	ON	-
	30 min	-	-	-

Sensor de luz / Sensor de luz

		6	7	8
ON	2 Lux	ON	ON	ON
	10 Lux	-	ON	ON
	25 Lux	ON	-	ON
	50 Lux	-	-	ON
	100 Lux	ON	ON	-
	Disable	-	-	-

SENSORES / SENSORES

1-10V

SC65BV2 Movimiento + Luminosidad
Movimento + luminosidade

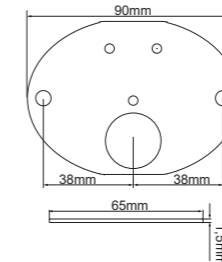

Fijación Techo / Fijação Tecto



MSC65V2



Mando para cambiar la configuración de SC65B y SC65C.
Comando para alterar configuração de SC65B y SC65C.

SC65CV2 Movimiento + Luminosidad
Movimento + luminosidade

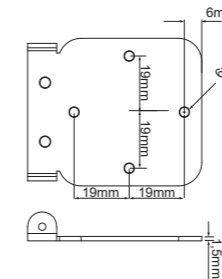

Fijación Pared / Fijação Parede



SL20 Luminosidad / Luminosidade

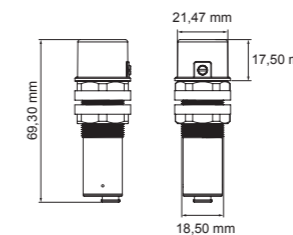

Potenciometro para ajustar el nivel de luz deseado
Potenciometro para ajustar o nivel de luz deseado

Tuerca de instalación
Porca de instalação



SENSORES / SENSORES



CSB20SMBL Movimiento + Luminosidad / Movimento + Luminosidade

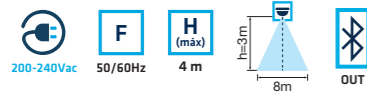
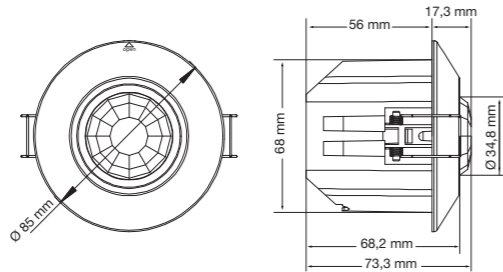

CSBE230ACS Enchufe + Movimiento / Tomada + Movimento

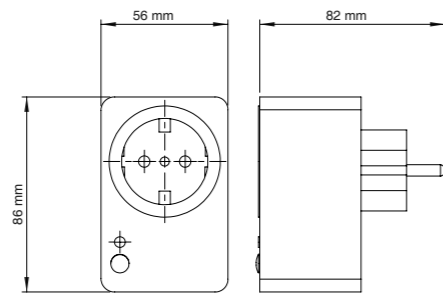

SENSORES / SENSORES



DALIsensor-T



Multisensor (luminosidad y movimiento) para sistema DALI
Multisensor (luminosidade e movimento) para sistema DALI

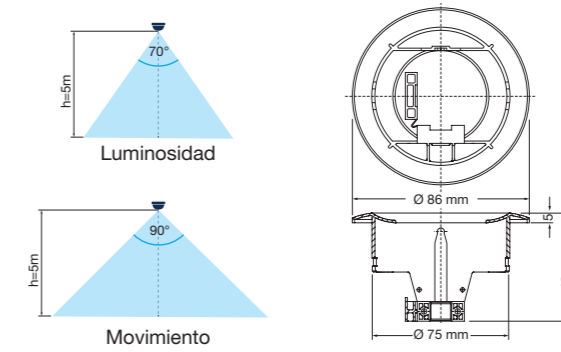

DALIsensor-S



Multisensor (luminosidad y movimiento) para sistema DALI
Multisensor (luminosidade e movimento) para sistema DALI

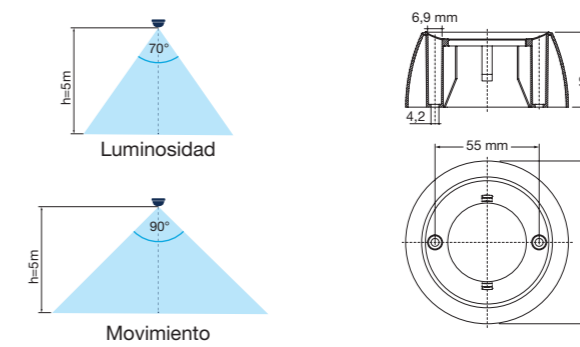

DALI_MRC



Mando para el control a distancia de DALIsensor-T y DALIsensor-S.
Mando para el control a distancia de DALIsensor-T y DALIsensor-S.

KIT DE EMERGENCIA / KIT DE EMERGÊNCIA

KET85

Kit emergencia para tubos T5 y T8 con una potencia de salida en emergencia de 3 a 20W con 1 hora de autonomía.
 Kit emergência para tubos T5 e T8 com uma potência de saída em emergência de 3 até 20W com 1 hora de autonomia.

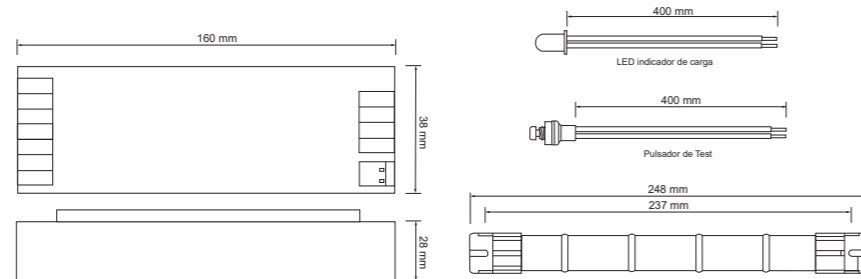

200-240Vac
 50/60Hz
 40mA
 160Vdc
 3-20W

KEU603

Kit emergencia universal para luminarias con driver externo con una potencia de salida en emergencia de hasta 4,5W con 3 horas de autonomía.
 Kit de emergência universal para lâmpadas com driver externo e potência de saída em emergência até 4,5W com 3 horas de autonomia.

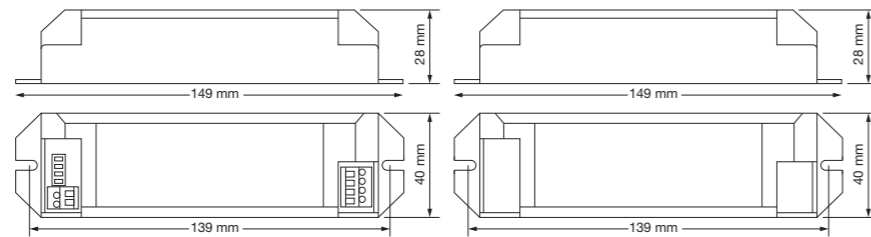

200-240Vac
 50/60Hz
 40mA
 24-60Vdc
 4,5W

KEL101

Kit emergencia universal para lámparas con driver interno con una potencia de salida en emergencia de hasta 10W con 1 hora de autonomía.
 Kit emergência universal para lâmpadas com driver interno e potência de saída em emergência até 10W com 1 hora de autonomia.

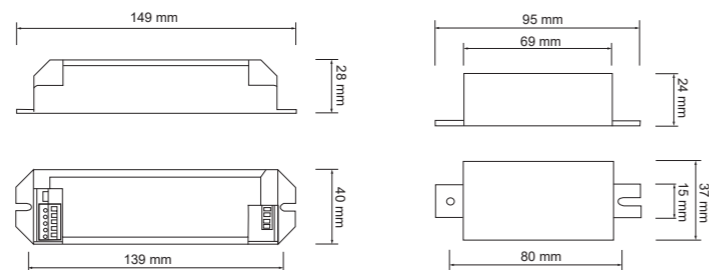

200-240Vac
 50/60Hz
 40mA
 230Vdc
 10W

KITS DE EMERGENCIA / KITS DE EMERGÊNCIA

KEU2403V2

Kit emergencia universal para luminarias con driver externo con una potencia de salida en emergencia de 6 a 30W con 3 horas de autonomía.
 Kit de emergência universal para lâmpadas com driver externo e potência de saída em emergência de 6 até 30W com 3 horas de autonomia.

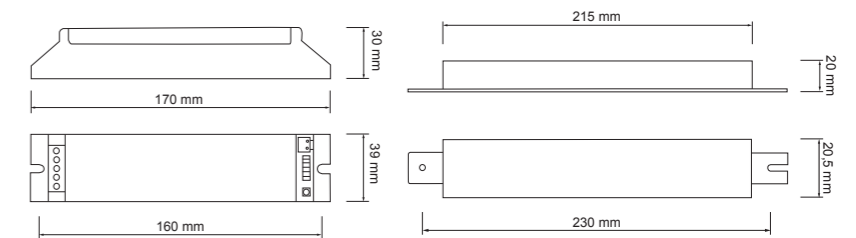

200-240Vac
 50/60Hz
 50mA
 9-60Vdc
 6-30W

KEIP65V2

Kit emergencia universal para luminarias con driver externo con una potencia de salida en emergencia de 6 a 30W con 3 horas de autonomía en caja IP65.
 Kit de emergência universal para lâmpadas com driver externo e potência de saída em emergência de 6 até 30W com 3 horas de autonomia em caixa IP65.

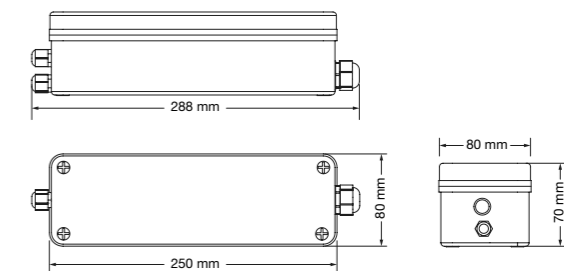

230Vac
 50/60Hz
 50mA
 9-60Vdc
 6-30W
 IP65

INTERFACE / INTERFACE

DMX Interface

SLESA-U9



SLESA-U10



SLESA-U11

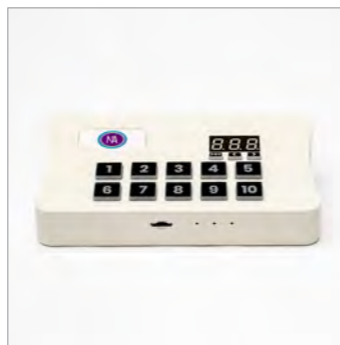

	SLESA-U9	SLESA-U10	SLESA-U11
Medidas	77 x 87 x 40 mm	77 x 87 x 40 mm	161 x 95 x 42 mm
Conexión USB	✓	✓	✓
Conexión Ethernet			✓
Conexión WIFI		✓	
Canales DMX	256	512	1024 (ampliable a 2048)
Nº de Escenas	20	99	99
Nº de Zonas	1	1	5
Memoria	20k	10k	microSD
Capacidad de memoria (20 ch.)	5600	3935	ilimitada
Capacidad de memoria (60 ch.)	2100	1550	ilimitada
Capacidad de memoria (512 ch.)		190	ilimitada
Conector de alimentación	mini USB	USB Type-C	USB Type-C
Conector interno	18 pins	HE10	
Puertos	8	8	16
Calendario Temporizador			ilimitada
Apps de control remoto		✓	✓

DALI_USB



Input Output
1 USB DALI

Direccionamiento, programación y parametrización de sistemas DALI

Orientação, programação e parametrização de sistemas DALI

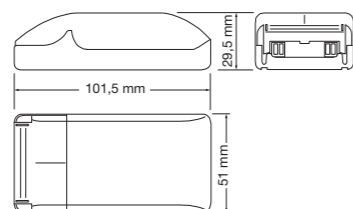

ENCHUFES CASAMBI / TOMADAS CASAMBI

CSBE230AC

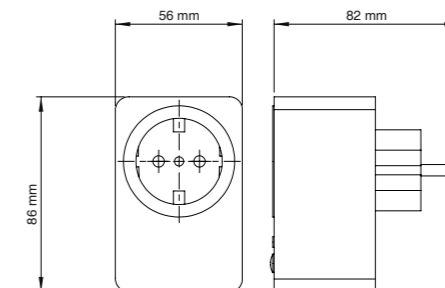

200-240Vac 50 Hz 16A (máx) 3680W IP20 -0°~+50° C

ACTUADORES CASAMBI / ACTUADORES CASAMBI

CSB4SWNE



NE CR2430 (1 ud.) 2 a 5 años IP20 -0°~+45° C

CSB4SWBL



BL CR2430 (1 ud.) 2 a 5 años IP20 -0°~+45° C

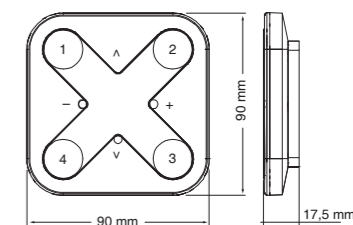

PROTECTORES / PROTETORES

NSB-10/230-C4-WW-IP

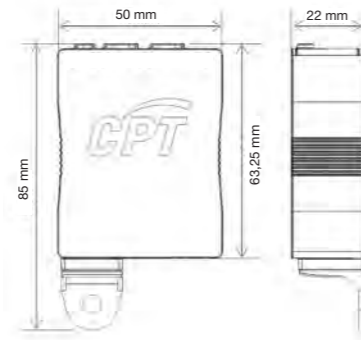

I (máx) 10kA
In 5kA
Voc 10kV
Cat C-High 10kV/10kA
Uc 320/255V
Up <=1,5/1,8 kV
 -40°- +80° C

NSB-10/230-CA-DD

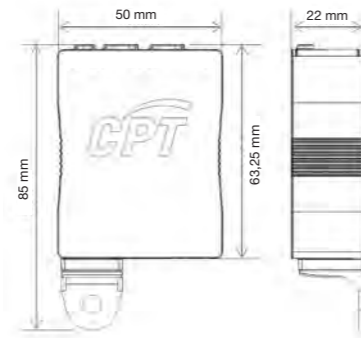

I (máx) 10kA
In 5kA
Voc 10kV
Cat C-High 10kV/10kA
Uc 320/255V
Up <=1,5/1,8 kV
 -40°- +80° C

INTERRUPTORES / INTERRUPTORES

DIP23 Interruptor-Programador horario digital para carril DIN / Interruptor-Programador horario digital para calha DIN

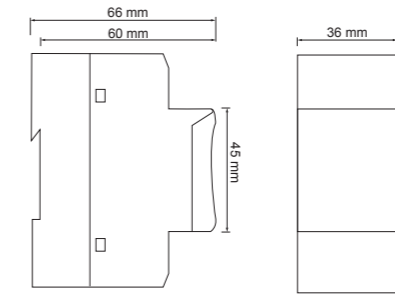

F 175-240Vac
F 50/60Hz
W 2300 W 16A / 250Vac (cutting power)
 -20°- +50° C

Programación semanal / Programação semanal

PMEC23 Interruptor-Programador horario para carril DIN. Interruptor-Programador horario para calha DIN.

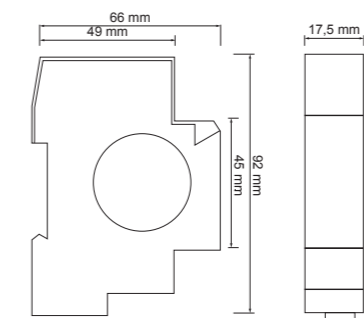

F 175-240Vac
F 50/60Hz
W 2300 W 16A / 240Vac (cutting power)
 -20°- +50° C

Programación diaria / Programação diária

TEMPORIZADORES / TEMPORIZADORES

TMEC23 Minutero-Temporizador de escalera para carril DIN. Minuto-temporizador de cada para calha DIN.

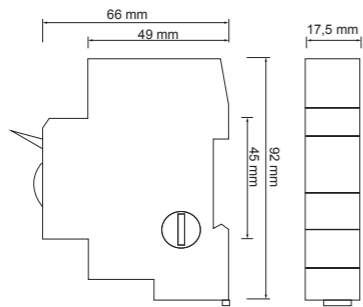

175-240Vac 50/60Hz 2300 W 16A / 240Vac (cutting power) -20°~+50° C

CONECTOR GU10 / CONECTOR GU10

GU10

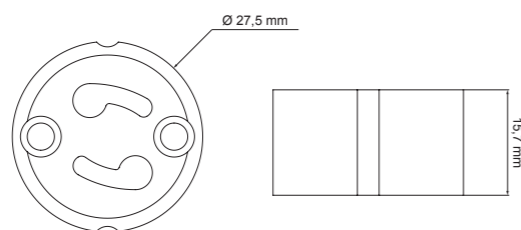

GU10

CONECTORES ESTANCOS / CONECTORES ESTANQUES

WCIP65

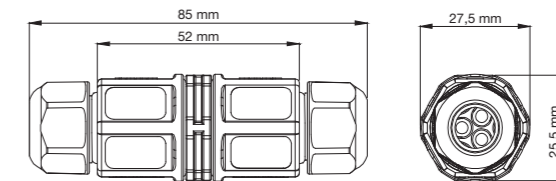

IP65 7 - 8,9 mm

WCIP65B2

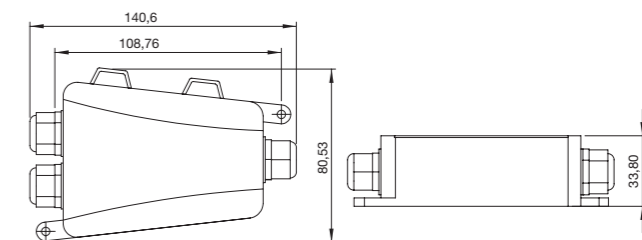

IP65 7 - 8,9 mm

WCIP65B3

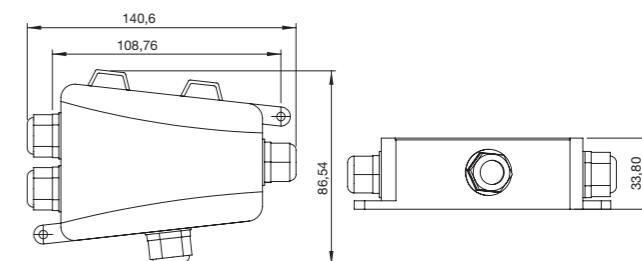

IP65 7 - 8,9 mm

Opciones de Regulación

Opções de regulação



OPCIONES DE REGULACIÓN / OPÇÕES DE REGULAÇÃO

DOWNLIGHT / DOWNLIGHT

ALASKA



	0/1-10 V	PUSH	DALI	UE DRIVER	CASAMBI
● DL25WUGRIP65BFBL	DL25WUGRIP65DMBFBL	DL25WUGRIP65DODBFBL	DL25WUGRIP65UEBFBL	DL25WUGRIP65CSBFBL	
● DL25WUGRIP65BNBL	DL25WUGRIP65DMBNBL	DL25WUGRIP65DODBNBL	DL25WUGRIP65UEBNBL	DL25WUGRIP65CSBNBL	
● DL25WUGRIP65BCBL	DL25WUGRIP65DMBCBL	DL25WUGRIP65DODBCBL	DL25WUGRIP65UEBCBL	DL25WUGRIP65CSBCBL	

NEVADA

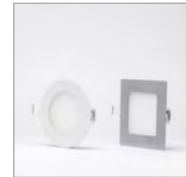

	0/1-10 V	PUSH	DALI	UE DRIVER	CASAMBI	12-24Vdc
● ND10RBFBL	*	ND10RPFBL	ND10RDABFBL	ND10RUEBFBL	ND10RCSBFBL	ND10R1224VBFBL
● ND10RBNBL	*	ND10RPNBL	ND10RDABNBL	ND10RUEBNBL	ND10RCSBNBL	ND10R1224VBNBL
● ND10RBCBL	*	ND10RPNBL	ND10RDABNBL	ND10RUEBNBL	ND10RCSBNBL	ND10R1224VBNBL
● ND10RBFPL	*	ND10RPFPL	ND10RDABFPL	ND10RUEBFPL	ND10RCSBFPL	ND10R1224VBFPL
● ND10RBNPL	*	ND10RPNPL	ND10RDABNPL	ND10RUEBNPL	ND10RCSBNPL	ND10R1224VBNPL
● ND10CBFBL	*	ND10CPBFBL	ND10CDABFBL	ND10CUEBFBL	ND10CCSBFBL	ND10C1224VBFBL
● ND10CBNBL	*	ND10CPBNBL	ND10CDABNBL	ND10CUEBNBL	ND10CCSBNBL	ND10C1224VBNBL
● ND10CBCBL	*	ND10CPBCBL	ND10CDABCBL	ND10CUEBCBL	ND10CCSBCBL	ND10C1224VBCBL
● ND10CBFPL	*	ND10CPBFPL	ND10CDABFPL	ND10CUEBFPL	ND10CCSBFPL	ND10C1224VBFPL
● ND10CBNPL	*	ND10CPBNPL	ND10CDABNPL	ND10CUEBNPL	ND10CCSBNPL	ND10C1224VBNPL

* 2 uds. ND10R con una fuente / 2 un. ND10R com apenas uma fonte

* 2 uds. ND10C con una fuente / 2 un. ND10C com apenas uma fonte

ACABADO BLANCO ACABAMENTO BRANCO	ACABADO PLATA ACABAMENTO PRATEADO
● 2xND10RDMBFBL	● 2xND10RDMBFPL
● 2xND10RDMBNBL	● 2xND10RDMBNPL
● 2xND10RDMBCBL	

ACABADO BLANCO ACABAMENTO BRANCO	ACABADO PLATA ACABAMENTO PRATEADO
● 2xND10CDMBFBL	● 2xND10CDMBFPL
● 2xND10CDMBNBL	● 2xND10CDMBNPL
● 2xND10CDMBCBL	

* 3 uds. ND10R con una fuente / 3 un. ND10R com apenas uma fonte

* 3 uds. ND10C con una fuente / 3 un. ND10C com apenas uma fonte

ACABADO BLANCO ACABAMENTO BRANCO	ACABADO PLATA ACABAMENTO PRATEADO
● 3xND10RDMBFBL	● 3xND10RDMBFPL
● 3xND10RDMBNBL	● 3xND10RDMBNPL
● 3xND10RDMBCBL	

ACABADO BLANCO ACABAMENTO BRANCO	ACABADO PLATA ACABAMENTO PRATEADO
● 3xND10CDMBFBL	● 3xND10CDMBFPL
● 3xND10CDMBNBL	● 3xND10CDMBNPL
● 3xND10CDMBCBL	

NEVADA



	0/1-10 V	PUSH	DALI	UE DRIVER	CASAMBI	12-24Vdc
● ND16RBFBL	ND16RDMBFBL	ND16RDABFBL	ND16RUEBFBL	ND16RCSBFBL	ND16R1224VBFBL	
● ND16RBNBL	ND16RDMBNBL	ND16RDABNBL	ND16RUEBNBL	ND16RCSBNBL	ND16R1224VBNBL	
● ND16RBCBL	ND16RDMBCBL	ND16RDABCBL	ND16RUEBCBL	ND16RCSBCBL	ND16R1224VBCBL	
● ND16RBFPL	ND16RDMBFPL	ND16RDABFPL	ND16RUEBFPL	ND16RCSBFPL	ND16R1224VBFPL	
● ND16RBNPL	ND16RDMBNPL	ND16RDABNPL	ND16RUEBNPL	ND16RCSBNPL	ND16R1224VBNPL	
● ND16CBFBL	ND16CDMBFBL	ND16CDABFBL	ND16CUEBFBL	ND16CCSBFBL	ND16C1224VBFBL	
● ND16CBNBL	ND16CDMBNBL	ND16CDABNBL	ND16CUEBNBL	ND16CCSBNBL	ND16C1224VBNBL	
● ND16CBCBL	ND16CDMBCBL	ND16CDABCBL	ND16CUEBCBL	ND16CCSBCBL	ND16C1224VBCBL	
● ND16CBFPL	ND16CDMBFPL	ND16CDABFPL	ND16CUEBFPL	ND16CCSBFPL	ND16C1224VBFPL	
● ND16CBNPL	ND16CDMBNPL	ND16CDABNPL	ND16CUEBNPL	ND16CCSBNPL	ND16C1224VBNPL	

OPCIONES DE REGULACIÓN / OPÇÕES DE REGULAÇÃO

DOWNLIGHT / DOWNLIGHT

NEVADA

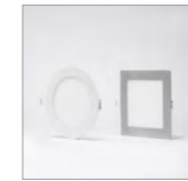

	0/1-10 V	PUSH	DALI	UE DRIVER	CASAMBI	12-24Vdc
● ND20RBFBL	ND20RDMBFBL	ND20RDABFBL	ND20RUEBFBL	ND20RCSBFBL	ND20R1224VBFBL	
● ND20RBNBL	ND20RDMBNBL	ND20RDABNBL	ND20RUEBNBL	ND20RCSBNBL	ND20R1224VBNBL	
● ND20RBCBL	ND20RDMBCBL	ND20RDABCBL	ND20RUEBCBL	ND20RCSBCBL	ND20R1224VBCBL	
● ND20RBFPL	ND20RDMBFPL	ND20RDABFPL	ND20RUEBFPL	ND20RCSBFPL	ND20R1224VBFPL	
● ND20RBNPL	ND20RDMBNPL	ND20RDABNPL	ND20RUEBNPL	ND20RCSBNPL	ND20R1224VBNPL	
● ND20CBFBL	ND20CDMBFBL	ND20CDABFBL	ND20CUEBFBL	ND20CCSBFBL	ND20C1224VBFBL	
● ND20CBNBL	ND20CDMBNBL	ND20CDABNBL	ND20CUEBNBL	ND20CCSBNBL	ND20C1224VBNBL	
● ND20CBCBL	ND20CDMBCBL	ND20CDABCBL	ND20CUEBCBL	ND20CCSBCBL	ND20C1224VBCBL	
● ND20CBFPL	ND20CDMBFPL	ND20CDABFPL	ND20CUEBFPL	ND20CCSBFPL	ND20C1224VBFPL	
● ND20CBNPL	ND20CDMBNPL	ND20CDABNPL	ND20CUEBNPL	ND20CCSBNPL	ND20C1224VBNPL	

NEVADA



	0/1-10 V	PUSH	DALI	UE DRIVER	CASAMBI	12-24Vdc
● ND10R-SBFBL	-	-	-	-	-	ND10R-S1224VBFBL
● ND10R-SBNBL	-	-	-	-	-	ND10R-S1224VBNBL
● ND10R-SBCBL	-	-	-	-	-	ND10R-S1224VBCBL
● ND10C-SBFBL	-	-	-	-	-	ND10C-S1224VBFBL
● ND10C-SBNBL	-	-	-	-	-	ND10C-S1224VBNBL
● ND10C-SBCBL	-	-	-	-	-	ND10C-S1224VBCBL

NEVADA



	0/1-10 V	PUSH	DALI	UE DRIVER	12-24Vdc
● ND16R-SBFBL	-	ND16R-SPBFBL	ND16R-SDABFBL	ND16R-SUEBFBL	ND16R-S1224VBFBL
● ND16R-SBNBL	-	ND16R-SPBNBL	ND16R-SDABNBL	ND16R-SUEBNBL	ND16R-S1224VBNBL
● ND16R-SBCBL	-	ND16R-SPBCBL	ND16R-SDABCBL	ND16R-SUEBCBL	ND16R-S1224VBCBL
● ND16C-SBFBL	-	ND16C-SPBFBL	ND16C-SDABFBL	ND16C-SUEBFBL	ND16C-S1224VBFBL
● ND16C-SBNBL	-	ND16C-SPBNBL	ND16C-SDABNBL	ND16C-SUEBNBL	ND16C-S1224VBNBL
● ND16C-SBCBL	-	ND16C-SPBCBL	ND16C-SDABCBL	ND16C-SUEBCBL	ND16C-S1224VBCBL

NEVADA



	0/1-10 V	PUSH	DALI	UE DRIVER	12-24Vdc
● ND20R-SBFBL	-	ND20R-SPBFBL	ND20R-SDABFBL	ND20R-SUEBFBL	ND20R-S1224VBFBL
● ND20R-SBNBL	-	ND20R-SPBNBL	ND20R-SDABNBL	ND20R-SUEBNBL	ND20R-S1224VBNBL
● ND20R-SBCBL	-	ND20R-SPBCBL	ND20R-SDABCBL	ND20R-SUEBCBL	ND20R-S1224VBCBL
● ND20C-SBFBL	-	ND20C-SPBFBL	ND20C-SDABFBL	ND20C-SUEBFBL	ND20C-S1224VBFBL
● ND20C-SBNBL	-	ND20C-SPBNBL	ND20C-SDABNBL	ND20C-SUEBNBL	ND20C-S1224VBNBL
● ND20C-SBCBL	-	ND20C-SPBCBL	ND20C-SDABCBL	ND20C-SUEBCBL	ND20C-S1224VBCBL

MICHIGAN



	0/1-10 V	PUSH	DALI	UE DRIVER
● DG20RBFBL	DG20RDMBFBL	DG20RDABFBL	DG20RUEBFBL	
● DG20RBNBL	DG20RDMBNBL	DG20RDABNBL	DG20RUEBNBL	

OPCIONES DE REGULACIÓN / OPÇÕES DE REGULAÇÃO

PANELES / PAINÉIS

ACROPOLIS



0/1-10 V	DALI
● P6060EUGR65BF P6060EUGR65D110BF P6060EUGR65DABF	
● P6060EUGR65BN P6060EUGR65D110BN P6060EUGR65DABN	

METROPOLIS



0/1-10 V	PUSH	DALI	UE DRIVER	CASAMBI	IP44
● P60X60EUGR9BF P60X60EUGR9DMBF P60X60EUGR9DABF P60X60EUGR9UEBF P60X60EUGR9CSBF P60X60EUGR944BF					
● P60X60EUGR9BN P60X60EUGR9DMBN P60X60EUGR9DABN P60X60EUGR9UEBN P60X60EUGR9CSBN P60X60EUGR944BN					

TRIPOLIS



0/1-10 V	PUSH	DALI	UE DRIVER	CASAMBI	IP44
● P6060UGRBF P6060UGRDMBF P6060UGRDABF P6060UGRUEBF P6060UGRCSBF P6060UGR44BF					
● P6060UGRBN P6060UGRDMBN P6060UGRDABN P6060UGRUEBN P6060UGRCSBN P6060UGR44BN					
● P6060UGRBC P6060UGRDMBC P6060UGRDABC P6060UGRUEBC P6060UGRCSBC P6060UGR44BC					
● P30120UGRBF P30120UGRDMBF P30120UGRDABF P30120UGRUEBF P30120UGRCSBF P30120UGR44BF					
● P30120UGRBN P30120UGRDMBN P30120UGRDABN P30120UGRUEBN P30120UGRCSBN P30120UGR44BN					
● P30120UGRBC P30120UGRDMBC P30120UGRDABC P30120UGRUEBC P30120UGRCSBC P30120UGR44BC					
● P60120UGRBF P60120UGRDMBF P60120UGRDABF P60120UGRUEBF P60120UGRCSBF P60120UGR44BF					
● P60120UGRBN P60120UGRDMBN P60120UGRDABN P60120UGRUEBN P60120UGRCSBN P60120UGR44BN					
● P60120UGRBC P60120UGRDMBC P60120UGRDABC P60120UGRUEBC P60120UGRCSBC P60120UGR44BC					

MICROPOLIS



0/1-10 V	PUSH	DALI	UE DRIVER
● P3030BN P3030DMBN P3030DABN P3030UEBN			
● P3060BN P3060DMBN P3060DABN P3060UEBN			

NEOPOLIS



0/1-10 V	PUSH	DALI	UE DRIVER	CASAMBI
● PS6060UGRBF PS6060UGRDMBF PS6060UGRDABF PS6060UGRUEBF PS6060UGRCSBF				
● PS6060UGRBN PS6060UGRDMBN PS6060UGRDABN PS6060UGRUEBN PS6060UGRCSBN				
● PS6060UGRBC PS6060UGRDMBC PS6060UGRDABC PS6060UGRUEBC PS6060UGRCSBC				

OPCIONES DE REGULACIÓN / OPÇÕES DE REGULAÇÃO

PANTALLAS ESTANCAS / ARMADURAS ESTANQUES

KLAUS



0/1-10 V	PUSH	DALI	1-10 V	UE DRIVER
● KLS60-10BF KLS60-10DABF KLS60-10D110BF KLS60-10UEBF				
● KLS60-10BN KLS60-10DABN KLS60-10D110BN KLS60-10UEBN				
● KLS60-20BF KLS60-20DABF KLS60-20D110BF KLS60-20UEBF				
● KLS60-20BN KLS60-20DABN KLS60-20D110BN KLS60-20UEBN				
● KLS120-20BF KLS120-20DABF KLS120-20D110BF KLS120-20UEBF				
● KLS120-20BN KLS120-20DABN KLS120-20D110BN KLS120-20UEBN				
● KLS120-40BF KLS120-40DABF KLS120-40D110BF KLS120-40UEBF				
● KLS120-40BN KLS120-40DABN KLS120-40D110BN KLS120-40UEBN				
● KLS150-25BF KLS150-25DABF KLS150-25D110BF KLS150-25UEBF				
● KLS150-25BN KLS150-25DABN KLS150-25D110BN KLS150-25UEBN				
● KLS150-55BF KLS150-55DABF KLS150-55D110BF KLS150-55UEBF				
● KLS150-55BN KLS150-55DABN KLS150-55D110BN KLS150-55UEBN				

CONDICIONES DE VENTA

CONDIÇÕES DE VENDA

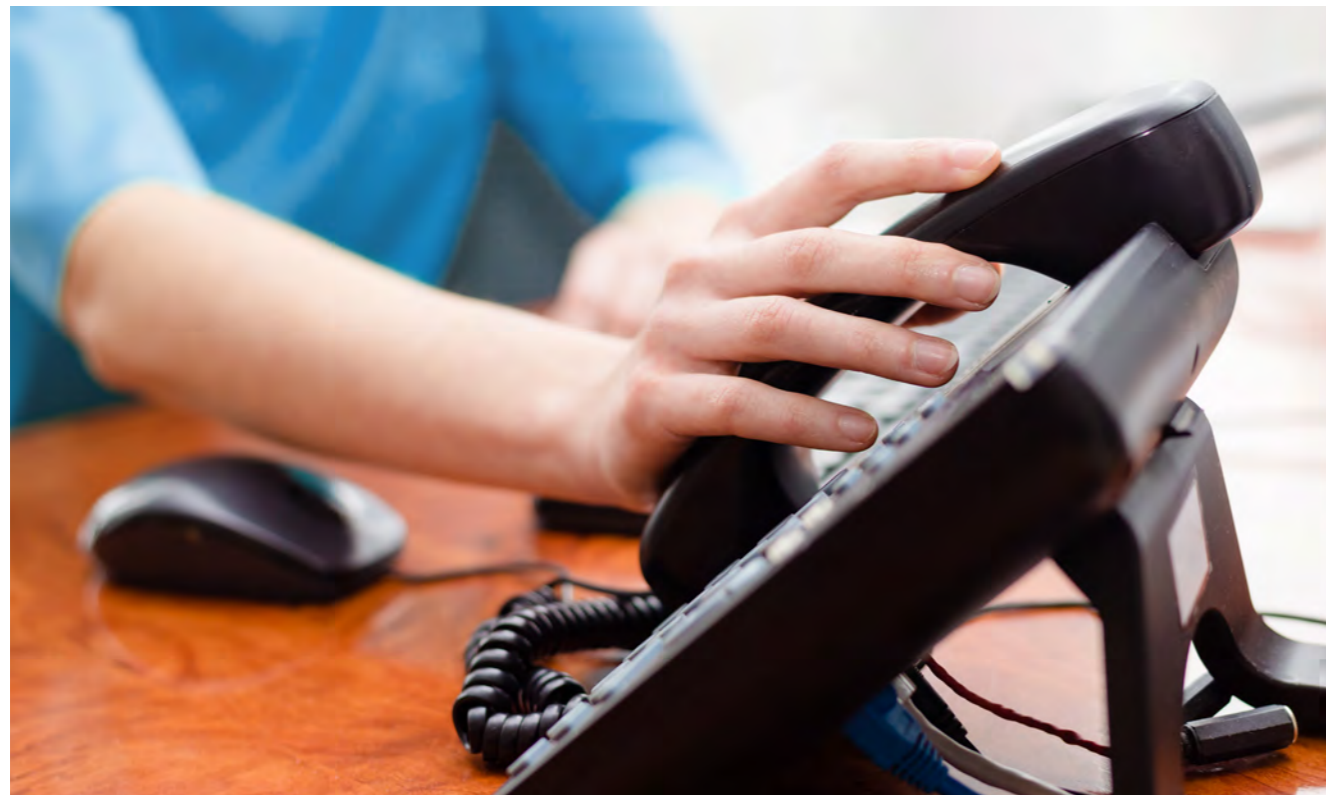

CALIDAD Y GARANTÍA

Todos nuestros productos se someten a distintas pruebas de calidad y están garantizados por un periodo de 3 y 5 años frente a cualquier defecto de fabricación. Consultar documento de calidad y garantía para cada uno de los productos.

Esta garantía no cubre deterioros sufridos por el uso indebido, incorrecta manipulación o una instalación inapropiada.

Threeline Technology, S.L. en continua mejora de la calidad y funcionalidad de sus productos, se reserva el derecho a modificar o suprimir cualquiera de ellos sin previo aviso. Puede consultar nuestra política de garantía en www.threelinegroup.com

ENVÍOS

Todos los pedidos con un valor superior al estipulado, se enviarán a portes pagados. Consultar condiciones con el Departamento Comercial.

Los pedidos de importe inferior podrán viajar con porte a cargo de Threeline Technology, S.L. mediante recargo en factura del coste de dicho porte. Este coste será establecido en base a la tarifa en vigor que la compañía de transportes tenga establecida con nosotros.

QUALIDADE E GARANTIA

Todos os nossos produtos são submetidos a diferentes provas de qualidade e estão garantidos por um período de 3, e 5 anos perante qualquer defeito de fabrico. Consultar documento de qualidade e garantia para cada um dos produtos.

Esta garantia não cobre deterioramentos sofridos pelo uso indevido, incorreta manipulação ou uma instalação inapropiada.

Threeline Technology, S.L. em contínua melhoria da qualidade e funcionalidade dos seus produtos, reserva-se o direito de modificar ou suprimir qualquer deles sem aviso prévio.

ENVIOS

Os preços de venda dos nossos artigos são os que figuram na nossa tarifa em vigor, com exceção de acordos pontuais confirmados por Threeline Technology, S.L. Todos os pedidos com un valor superior ao estipulado serão enviados com portes pagos. Consulte as condições com o Departamento Comercial.

Os pedidos de valor inferior poderão viajar com porte a cargo de Threeline Technology, S.L. mediante faturação do custo do referido porte. Este custo será estabelecido com base na tarifa em vigor que a companhia de transportes tenha estabelecida connosco.

PLAZOS DE ENTREGA

Aunque los plazos de entrega se cumplen en un porcentaje muy elevado, no hay que olvidar que no siempre son calculados en base a parámetros controlados por Threeline Technology, S.L., por este motivo no podemos garantizar en todas las ocasiones su cumplimiento al 100%. Threeline Technology, S.L. no admitirá reclamaciones por daños y perjuicios por parte del cliente motivados por demora en la entrega.

FORMAS DE PAGO

Las condiciones de pago serán las acordadas con nuestros clientes. Los vencimientos de los pagos mediante cualquier documento de pago legalmente aceptado, deberán de respetarse puntualmente. Las demoras en el pago traen consigo, con efecto inmediato, la anulación de todos los compromisos pactados.

RECLAMACIONES

En ningún caso se aceptarán reclamaciones sobre el estado de la mercancía o sobre errores en envíos una vez pasados 10 días laborables desde su recepción.

REPARACIONES

Dentro del periodo de garantía la reparación o reposición de materiales defectuosos se realizará sin cargo para el cliente. En todos los casos en que resulte exigible la garantía nuestra responsabilidad se limita a la entrega gratuita de un nuevo producto que sustituya al averiado o al reembolso íntegro del precio del producto afectado, quedando expresamente excluida cualquier responsabilidad por daños y perjuicios o cualesquiera otros gastos, cargos o indemnizaciones.

DEVOLUCIONES

Todas las devoluciones deben ser aceptadas previamente por Threeline Technology, S.L.

Las devoluciones o envíos de material a las instalaciones de Threeline Technology, S.L. ya sea para su abono, sustitución o reparación deberán efectuarse siempre a portes pagados.

No se admitirán devoluciones de material fabricado a medida o traído expresamente para el cliente ni de aquellos en los que Threeline Technology, S.L. haya realizado alguna adaptación específica.

La mercancía que sea devuelta por razones ajenas a Threeline Technology, S.L. debe encontrarse en perfectas condiciones para su posterior venta y estar referenciada en la tarifa vigente. La mercancía será abonada a su valor neto cargándose un demérito mínimo del 10% en concepto de participación en los costes de revisión y manipulado.

PRAZO DE ENTREGA

Embora os prazos de entrega se cumpram numa percentagem muito elevada, não convém esquecer que nem sempre são calculados com base em parâmetros controlados por Threeline Technology, S.L., por este motivo não podemos garantir em todas as ocasiões o seu cumprimento a 100%. Threeline Technology, S.L. não admitirá reclamações por danos e prejuízos por parte do cliente motivados por demora na entrega.

FORMA DE PAGAMENTO

As condições de pagamento serão as acordadas com os nossos clientes. Os vencimentos dos pagamentos mediante qualquer documento de pagamento legalmente aceite deverão ser respeitados pontualmente. As demoras no pagamento trazem consigo, com efeito imediato, a anulação de todos os compromissos pactuados.

RECLAMAÇÕES

Em nenhum caso serão aceites reclamações sobre o estado da mercadoria ou sobre erros em envios após 10 dias úteis desde a sua receção.

REPARAÇÕES / REPOSIÇÕES

Dentro do período de garantia a reparação ou reposição de materiais defeituosos será realizada sem cargos para o cliente. Em todos os casos em que seja exigível a garantia a nossa responsabilidade limita-se à entrega gratuita de um novo produto que substitua o avariado ou o reembolso integral do preço do produto afetado, ficando expressamente excluída qualquer responsabilidade por danos e prejuízos ou quaisquer outros gastos, cargos ou indemnizações.

DEVOLUÇÕES

Todas as devoluções devem ser aceites previamente por Threeline Technology, S.L.

As devoluções ou envios de material às instalações de Threeline Technology, S.L., seja para o seu pagamento, substituição ou reparação deverão ser sempre efetuadas com portes pagos.

Não serão admitidas devoluções de material fabricado à medida ou trazido expressamente para o cliente nem naqueles em que Threeline Technology, S.L. tenha realizado alguma adaptação específica.

A mercadoria que seja devolvida por motivos alheios a Threeline Technology, S.L., deve encontrar-se em perfeitas condições para a sua posterior venda e estar referenciada na tarifa vigente. A mercadoria será paga ao seu valor líquido sendo carregado um demérito mínimo de 10% em conceito de participação nos custos de revisão e manipulação.

POLÍTICA DE GARANTÍA

POLÍTICA DE GARANTIA

Los productos Threeline que no funcionen correctamente como resultado de un defecto del mismo durante el periodo especificado estarán cubiertos por la garantía THREELINE:

· El periodo de garantía, dependiendo del producto, comienza con la fecha de la factura.

· Bajo solicitud, se podrá valorar una extensión de garantía u ofrecer una garantía de proyecto personalizada tras la evaluación de las condiciones de aplicación por el Departamento Técnico. La extensión de garantía se entenderá ampliada cuando acompañe un certificado de calidad y garantía asociado al nº de presupuesto y/o albarán.

· La presente garantía es válida únicamente para productos vendidos en la región EMEA (Europa, Oriente Medio y África). En otras regiones pueden regir otras condiciones.

· Los productos deben estar correctamente instalados y funcionar de acuerdo con las instrucciones del fabricante.

· La presente garantía no cubre los gastos de mano de obra para el desmontaje y montaje de los productos.

· Un representante de Threeline tendrá acceso a los productos defectuosos. Si los Productos u otras piezas son objeto de sospecha, el representante de Threeline tendrá derecho a invitar a representantes de otros fabricantes para evaluar los sistemas de iluminación.

· El periodo de garantía se basa en un funcionamiento de 3.000h al año como máximo a una temperatura ambiente de 25°C y con un espacio de 10mm alrededor del cuerpo de los productos.

· Esta garantía solo cubre los productos a los que se les ha dado el uso para el que fueron creados y no cubre deterioros sufridos por el uso indebido, incorrecta manipulación o una instalación inapropiada.

Las condiciones normales de instalación y funcionamiento según Threeline son las siguientes:

· Las condiciones de funcionamiento son acordes con la información reflejada en los embalajes de los productos.

· La temperatura a la que puede estar expuesta el producto no debe sobrepasar la temperatura ambiente estándar. Deberá consultarse con fábrica la instalación o uso en condiciones ambientales extremas para su aprobación.

· La humedad relativa de la instalación nunca debe superar la categoría IP del producto.

· Los productos deben funcionar en una luminaria abierta (luminaria cerrada para tubo LED) con un mínimo de 10 mm de aire alrededor del cuerpo de los productos.

· Los productos no deben someterse a más de un total de 20.000 conmutaciones rápidas (tiempo entre el encendido y apagado –‘on’ y ‘off’– inferior a 10 minutos).

· La instalación eléctrica en la que funciona el producto no debe estar sometida a fluctuaciones de tensión dentro de un intervalo que sobrepase 230 V +/- 10%.

Os produtos Threeline que não funcionem de modo certo como resultado dum defeito dele durante o período especificado estarão cobertos pela garantia THREELINE:

- O período de garantia de dois a sete anos, dependendo do produto, começa com a data da fatura.

- Sob pedido, será possível avaliar uma extensão de garantia ou oferecer uma garantia de projeto personalizada após a avaliação das condições de aplicação pelo departamento técnico. A extensão de garantia entender-se-á ampliada quando estiver acompanhada duma certidão de qualidade e garantia associada ao nº de orçamento e/ou nota de entrega.

- A presente garantia tem validade unicamente para produtos vendidos na região EMEA (Europa, Oriente Médio e África). Noutras regiões podem regir outras condições.

- Os produtos devem estar instalados corretamente e funcionar conforme às instruções do fabricante.

· A presente garantia não cobre os custos de mão de obra para a desmontagem e montagem dos produtos.

- Um representante da Threeline terá acesso aos Produtos defeituosos. Se os produtos ou outras peças são objeto de suspeita, o representante da Threeline terá direito de convidar os representantes de outros fabricantes para avaliar os sistemas de iluminação.

- O período de garantia está baseado num funcionamento de 3.000h por ano no máximo a uma temperatura ambiente de 25°C e com um espaço de 10mm à volta do corpo dos produtos.

- Esta garantia apenas cobre os produtos aos que se lhes deu o uso para o que foram criados e não cobre degradações sofridos pelo uso indevido, manuseio errado ou uma instalação inapropiada.

As condições normais de instalação e funcionamento conforme à Threeline são as seguintes:

- As condições de funcionamento são de acordo com a informação que aparece nas embalagens dos produtos.

- A temperatura a que pode estar exposto o produto não deve ultrapassar a temperatura ambiente standard. Deverá ser consultado com a fábrica a instalação ou uso em condições ambientais extremas para a sua aprovação.

- A humidade relativa da instalação nunca deve superar a categoria IP do produto.

- Os produtos devem funcionar numa luminária aberta (luminária fechada para tubo LED) com um mínimo de 10 mm de ar à volta do corpo dos produtos.

- Os produtos não se devem submeter a mais dum total de 20.000 comutações rápidas (tempo entre o aceso e apagado –‘on’ e ‘off’– inferior a 10 minutos)

- A instalação elétrica na que funciona o produto não deve estar submetida a flutuações de tensão dentro dum intervalo que ultrapasse 230 V +/- 10%.

TÉRMINOS Y CONDICIONES

· La garantía de Threeline se aplicará únicamente al comprador, siempre que este devuelva los productos cubiertos por la presente garantía dentro del periodo de aplicación establecido.

· El producto deberá enviarse perfectamente embalado a la dirección de Threeline Technology, S.L. El cliente será responsable de los daños sufridos por el transporte.

· Esta garantía sólo será válida cuando el producto se haya conectado e instalado correctamente, y esté funcionando con los valores eléctricos, intervalo de funcionamiento y condiciones medioambientales previstas en las especificaciones, guías de aplicación, normas IEC o cualquier otro documento suministrado con los productos.

· Threeline reparará o sustituirá, según su criterio, el producto o componente defectuoso del mismo, o abonará al comprador el importe del precio de compra. Para evitar confusiones, ‘reparará o sustituirá el Producto o componente defectuoso del mismo’ incluirá sin limitaciones los costes o gastos de mano de obra, pero en ningún caso, las actividades, costes o gastos de extracción y reinstalación.

· Si Threeline opta por sustituir el producto, pero no puede hacerlo porque ya no se fabrica o no se encuentra disponible, Threeline puede devolver al comprador la cantidad abonada o sustituir el producto por otro equiparable (cuyo diseño o especificaciones pueden variar ligeramente).

· Los agentes, distribuidores o representantes no están autorizados a cambiar, modificar o ampliar ningún aspecto de los términos de garantía estipulados por Threeline.

· Cuando la reclamación de garantía esté justificada, Threeline correrá con los gastos de transporte. Threeline podrá facturar al cliente los productos devueltos que no sean defectuosos o no conformes conjuntamente con los gastos de transporte, comprobación y gestión asociados.

· La presente es una garantía limitada y excluye, entre otros aspectos, la instalación, el acceso a productos (andamiaje, elevadores, etc.) y los daños especiales, accesorios e indirectos (como la pérdida de ingresos/ganancias, daño a la propiedad u otros costes ampliados no mencionados anteriormente), y por otra parte, las limitaciones y condiciones establecidas en la política de garantía respectiva y en las presentes condiciones amplían su definición.

· Threeline no se hace responsable de las condiciones del suministro eléctrico, incluyendo los picos de tensión, las fluctuaciones de tensión los sistemas de control de ondulación de corriente que sobrepasen los límites especificados de los productos y los definidos en las normas de suministro pertinentes (por ejemplo, las normas EN 50160).

· Con respecto a los productos vendidos por Threeline al comprador pero que no son de la marca, Threeline no otorga ninguna garantía, expresa o implícita, incluyendo sin limitaciones las garantías de comerciabilidad o idoneidad para un fin determinado; sin embargo, pondrá a disposición del comprador previa petición, pero sólo en la medida permitida por la ley y los contratos pertinentes, las garantías del fabricante del producto correspondiente.

TERMOS E CONDIÇÕES

- A garantia da Threeline aplicar-se-á unicamente ao comprador. Sempre que ele devolva os produtos cobertos pela presente garantia dentro do período de aplicação estabelecido.

- O produto deverá ser enviado perfeitamente embalado ao endereço da Threeline Technology, S.L. O cliente será responsável pelos danos sofridos pelo transporte.

- Esta garantia apenas será válida quando o produto se tenha ligado e instalado corretamente, e estiver a funcionar com os valores elétricos, intervalo de funcionamento e condições ambientais previstas nas especificações, guias de aplicação, normas IEC ou qualquer outro documento subministrado com os Produtos.

- A Threeline reparará ou substituirá, conforme o seu critério, o produto ou componente defeituoso do mesmo, ou reembolsará ao comprador o valor do preço de compra. Para evitar confusões, ‘reparará ou substituirá o Produto ou componente defeituoso do mesmo’ incluirá sem limites os custos ou custos de mão de obra, mas em nenhum caso, as atividades, custos ou custos de extração e reinstalação.

- Se a Threeline optar por substituir o produto, mas não pode fazê-lo porque já não se fabrica ou não se encontra disponível, a Threeline pode reenbolsar o comprador ou substituir o produto por outro equiparável (cujo desenho ou especificações podem alterar levemente).

- Os agentes, distribuidores ou representantes não estão autorizados a mudar, alterar ou ampliar nenhum aspeto dos termos de garantia estabelecidos pela Threeline.

- Quando a reclamação de garantia estiver justificada, a Threeline assume os custos de transporte. A Threeline poderá faturar ao cliente os produtos devolvidos que não sejam defeituosos ou não conformes junto com os custos de transporte, verificação e gestão associados.

- A presente é uma garantia limitada e exclui, entre outros aspetos, a instalação, o acesso a produtos (andaimos, elevadores, etc.) e os danos especiais, acessórios e indirectos (como a perda de ingressos/ganhos, dano à propriedade ou outros custos ampliados não mencionados anteriormente), e por outra parte, as limitações e condições estabelecidas na política de garantia respetiva e nas presentes condições ampliam a sua definição.

- A Threeline não é responsável pelas condições da rede elétrica, incluindo os picos de tensão, as flutuações de tensão os sistemas de controlo de ondulação de corrente que ultrapassem os limites especificados dos produtos e os definidos nas normas de subministro pertinentes (por exemplo, as normas EN 50160).

- Com relação aos produtos vendidos pela Threeline ao comprador mas que não são da marca, a Threeline não outorga nenhuma garantia, expressa ou implícita, incluindo sem limitações as garantias de comerciabilidade ou idoneidade para um fim determinado; de qualquer modo colocará a disposição do comprador prévio pedido, mas apenas na medida permitida pela lei e os contratos pertinentes, as garantias do fabricante do produto correspondente.

NOTAS / NOTAS

Lined area for notes on page 316.

NOTAS / NOTAS

Lined area for notes on page 317.

DISEÑO Y MAQUETACIÓN

DESENHO E MAQUETAÇÃO

© Departamento de Marketing de Threeline.

Impresión: Febrero 2023 - 1ª edición.

Queda prohibida la reproducción total o parcial de las imágenes, textos, ilustraciones y conceptos gráficos de este catálogo sin previa autorización por THREELINE TECHNOLOGY, S.L.

Debido a los procesos técnicos de impresión, los colores impresos en este catálogo pueden sufrir variaciones con respecto al color original del producto. Los datos incluidos en este catálogo pueden ser objeto de error.

Debido a la continua mejora y evolución constante de nuestros productos, Threeline se reserva el derecho a modificar especificaciones técnicas, así como actualizar los valores técnicos y características de los productos en sus fichas técnicas, disponibles en:

www.threelinegroup.com

Threeline Technology S.L. se reserva el derecho a cualquier modificación del producto sin previo aviso.

© Departamento de Marketing da Threeline

Impressão: Fevereiro 2023 - 1ª edição.

Fica proibida a reprodução total ou parcial das imagens, textos, ilustrações e conceitos gráficos deste catálogo sem autorização prévia da THREELINE TECHNOLOGY, S.L.

Devido aos processos técnicos de impressão, as cores impressas neste catálogo podem sofrer alterações com relação à cor original do produto. Os dados incluídos neste catálogo podem estar sujeitos a erros.

Devido à melhora continua e evolução constante dos nossos produtos, a Threeline reserva o direito a alterar especificações técnicas, como também a atualizar os valores técnicos e características dos produtos nas suas fichas técnicas, disponíveis em:

www.threelinegroup.com

A Threeline Technology S.L. reserva o direito a qualquer alteração do produto sem aviso prévio.

Pol. El Mugerón · C/ Pulimentadores, 1 · Apdo. 633
02640 Almansa (Albacete) · Spain
T. +34 967 318 293 · F. +34 967 340 002
tl@threeline.es
ThreelineGroup.com

THREELINE

Catálogo siempre
actualizado:



ThreelineGroup.com