



**Especial  
TRACKLIGHT**



# APOLO

## Tracklight de formato compacto

Possui uma reprodução de cores muito alta, CRI>90, conseguindo assim uma visualização real sem distorcer a cor.

Escolha o modelo que melhor se adapta às suas necessidades:

- 3 Formatos: tracklight, encastrar e superfície.
- 3 Potências: 9W, 18W e 30W.
- 5 Lentes: 15°, 23°, 38°, 45° e 60°.
- 3 temperaturas de cor: 4000K, 3000K e 2700K.
- 2 Acabamentos: preto e branco.

Também é oferecida a possibilidade de escolher o anel interior da luminária em cor dourada.

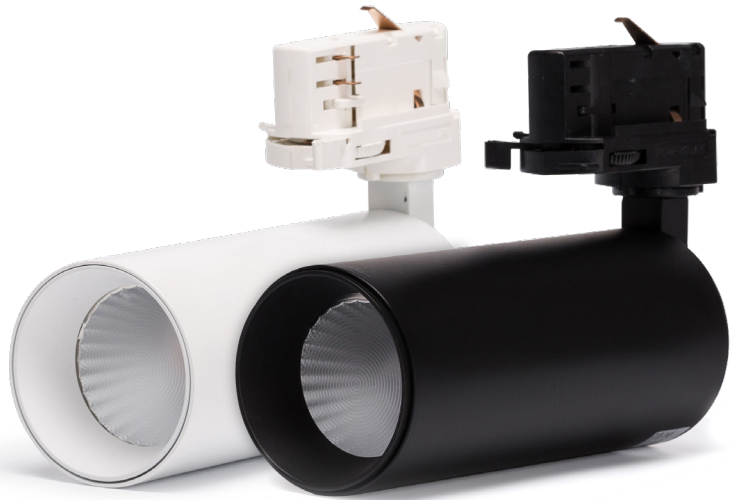

### • Características

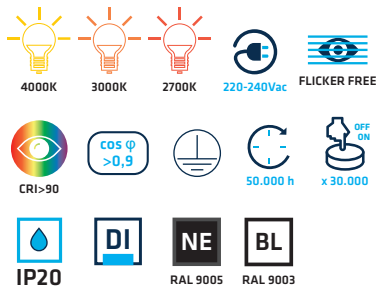

### • Opc. de Reg.



### • Ângulos

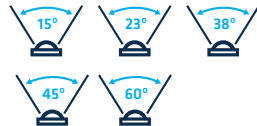

Opção aro dourado



E como **NOVIDADE** poderá escolher a luminária APOLO para lâmpadas GU10. Disponível a partir de 24/09. Lâmpada não incluída.



CR Calha	POL2.GU10	B <input type="checkbox"/>
EM Encastrar		N <input checked="" type="checkbox"/>
SP Superfície		D <input type="checkbox"/>

\*Crie a sua referência

Formato	W	CRI	CCT	Ângulo	Opção	ARO
CR Calha	POL2. (Apolo) 09 9 W	9 >90	4 4000K	15 15°	B <input type="checkbox"/>	B <input type="checkbox"/>
EM Encastrar	18 18 W	3 3000K	23 23°	N <input checked="" type="checkbox"/>	N <input checked="" type="checkbox"/>	
SP Superfície	30 30 W	2 2700K	38 38°	D <input type="checkbox"/>	D <input type="checkbox"/>	
			45 45°			
			60 60°			

OPCIONAL



W	CCT	N	SP
9 W	4000K	1080 lm	909 lm
	3000K	1071 lm	873 lm
	2700K	1062 lm	855 lm

W	CCT	N	SP
18 W	4000K	2160 lm	1818 lm
	3000K	2142 lm	1746 lm
	2700K	2124 lm	1710 lm

W	CCT	N	SP
30 W	4000K	3600 lm	3030 lm
	3000K	3570 lm	2910 lm
	2700K	3540 lm	2850 lm

# HERMES

O tracklight mais completo do mercado numa única luminária, com corpo em alumínio.

Incorpora no mesmo produto três temperaturas de cor e três potências diferentes, 30W, 35W e 40W, que poderá seleccionar manualmente.

Além disso, possui zoom ajustável entre 24° e 60° e CRI>90. Terá apenas de escolher o acabamento branco ou preto.

O mesmo produto, diferentes possibilidades!



## • Características

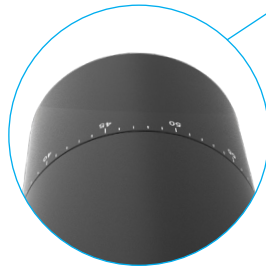
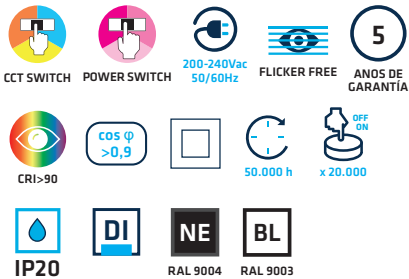

24°-60° **Ângulo ajustável 24°~60°**

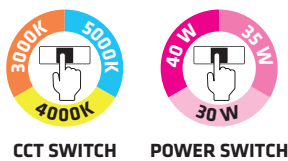

CCT	W	Beam Spread	Light Output	
			Beam Spread	Light Output
● 5000K ● 4000K ● 3000K	30 W	24° ~ 60°	0	3600 lm
			1	3000 lm
			2	2850 lm
● 5000K ● 4000K ● 3000K	35 W	24° ~ 60°	0	4200 lm
			1	3500 lm
			2	3325 lm
● 5000K ● 4000K ● 3000K	40 W	24° ~ 60°	0	4800 lm
			1	4000 lm
			2	3800 lm

Adicionar atrás da referência um 0 para acabamento branco ou 2 para acabamento preto.

# ARES

## O modelo de tracklight mais competitivo.

Disponível em preto ou branco e com seleção manual da temperatura de cor (CCT SWITCH) e da potência.

Terá apenas que escolher entre acabamento branco ou acabamento preto e o ângulo que precisa de 45° ou 60°.  
As potências e temperaturas das cores são ajustadas diretamente no produto.



### Características

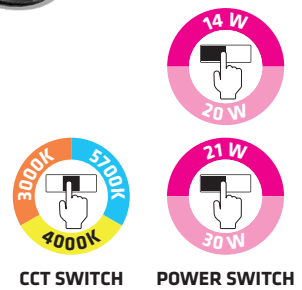
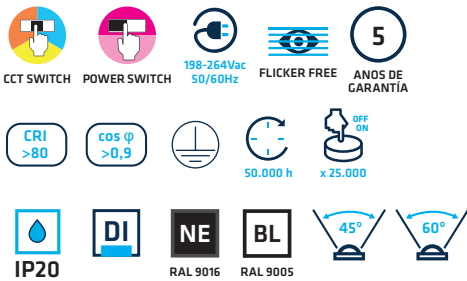

Modelo	Acabamento	Ângulo	W	CCT	Beam Diameter (mm)	Beam Diameter (mm)
CRA1420CCT45	0 <input type="checkbox"/> 2 <input checked="" type="checkbox"/>	45°	14 W	5700K	1580	1300
				4000K	1580	1300
	3000K			1455	1180	
	20 W		5700K	2170	1770	
			4000K	2170	1770	
			3000K	1960	1560	
CRA1420CCT60	0 <input type="checkbox"/> 2 <input checked="" type="checkbox"/>	60°	14 W	5700K	1580	1300
				4000K	1580	1300
	3000K			1455	1180	
	20 W		5700K	2170	1770	
			4000K	2170	1770	
			3000K	1960	1560	
CRA2130CCT45	0 <input type="checkbox"/> 2 <input checked="" type="checkbox"/>	45°	21 W	5700K	2350	1950
				4000K	2350	1950
	3000K			2190	1770	
	30 W		5700K	3180	2570	
			4000K	3180	2570	
			3000K	2940	2350	
CRA2130CCT60	0 <input type="checkbox"/> 2 <input checked="" type="checkbox"/>	60°	21 W	5700K	2350	1950
				4000K	2350	1950
	3000K			2190	1770	
	30 W		5700K	3180	2570	
			4000K	3180	2570	
			3000K	2940	2350	



# METIS

## O tracklight para lâmpadas GU10.

Facilidade de instalação e design minimalista são as suas principais características.

Graças ao seu suporte de ventosa, poderá instalar a lâmpada LED GU10 sem qualquer esforço.

Disponível em tracklight ou applique de superfície, para 1, 2, 3 ou 4 unidades por luminária e orientação independente de cada um dos pontos de luz.



### VENTOSA INCLUÍDA\*

\*Necessária para a colocação e troca de lâmpada.



### METIS TRACKLIGHT



REF. CRMTSNE



REF. CRMTSBL

### METIS SUPERFÍCIE 1 UD.



REF. SP1MTSNE



REF. SP1MTSBL

### METIS SUPERFÍCIE 3 UDS.



REF. SP3MTSNE



REF. SP3MTSBL

### METIS SUPERFÍCIE 2 UDS.



REF. SP2MTSNE



REF. SP2MTSBL

### METIS SUPERFÍCIE 4 UDS.



REF. SP4MTSNE



REF. SP4MTSBL

# ACESSÓRIO PARA CALHA DE TRÊS FASES

## Acessórios para concretizar qualquer tipo de instalação.

Procura a solução perfeita para iluminar o seu ambiente comercial, público ou escritório? Não procure mais! A THREELINE oferece a escolha indiscutível dos profissionais e fabricantes de iluminação.

### Qualidade incomparável:

Com garantia de 100% de qualidade. Confie na nossa longa experiência e aproveite a iluminação mais confiável do mercado.

### Versatilidade:

De lojas e armazéns a restaurantes, aeroportos e edifícios públicos, adaptamo-nos a qualquer ambiente.

### Expansão fácil:

Precisa de mais luz? Não há problema. A estrutura modular facilita a expansão de acordo com as suas necessidades. Os designers podem ajustar o sistema ao espaço de forma adequada e os conectores confiáveis permitem uma montagem rápida e fácil, economizando custos no processo!

Não perca a oportunidade de transformar os seus espaços com os nossos acessórios de tracklight. Ilumine com inteligência e estilo!

Observe o exemplo que propomos e verá que nenhuma instalação lhe resiste.

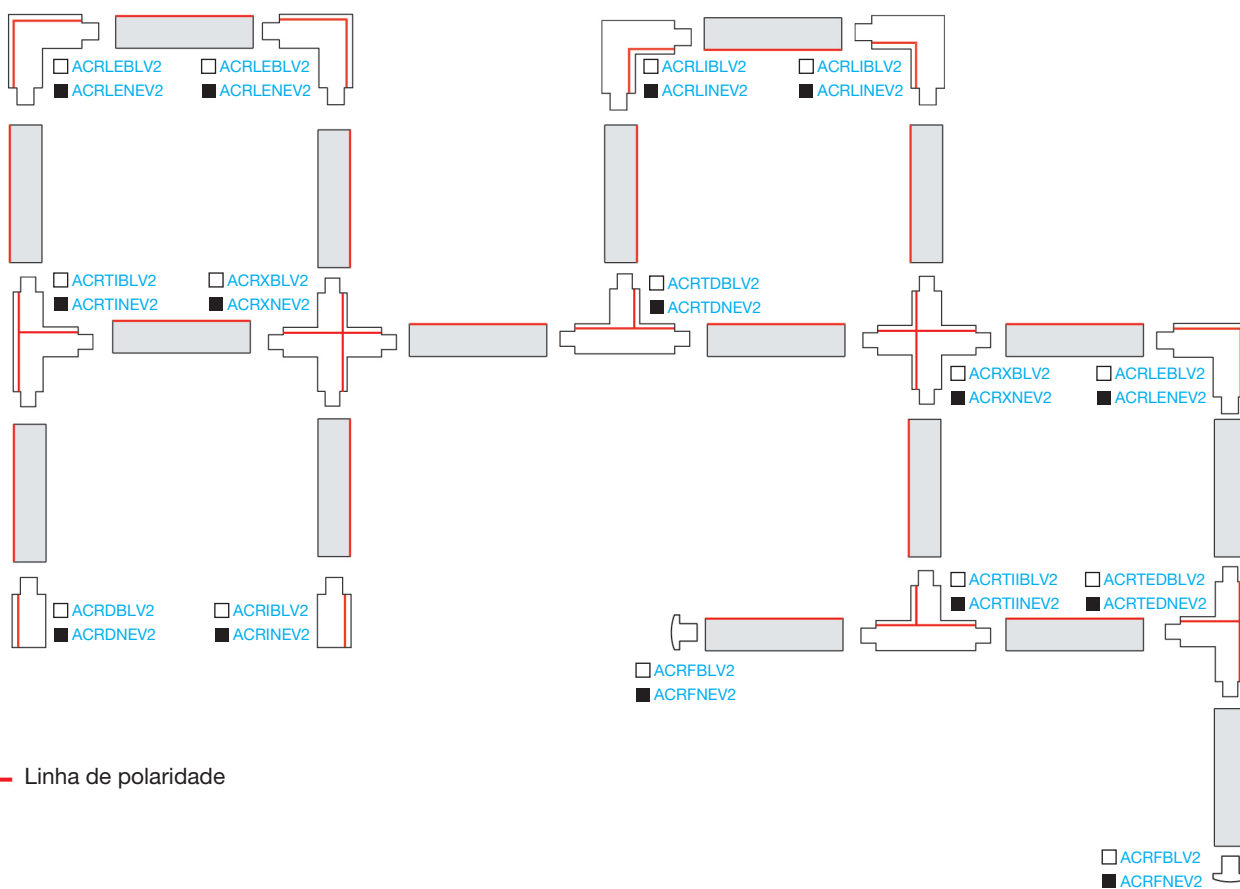
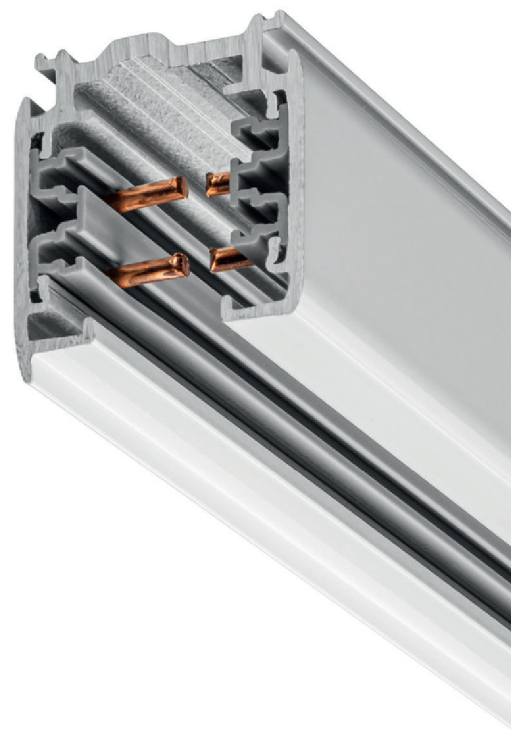



## Calha de SUPERFÍCIE

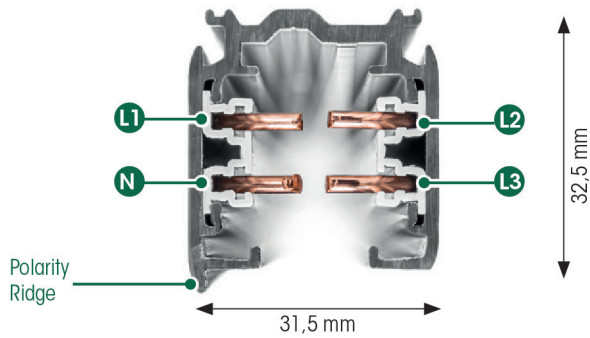

## Calha de ENCASTRAR

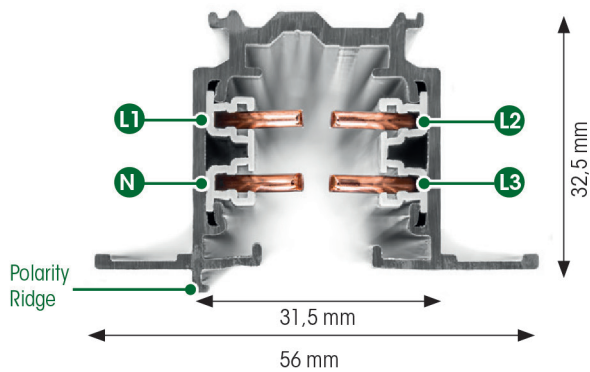

## Seção transversal do condutor de potência

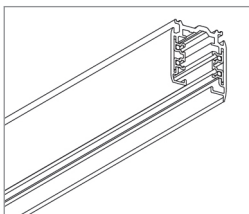
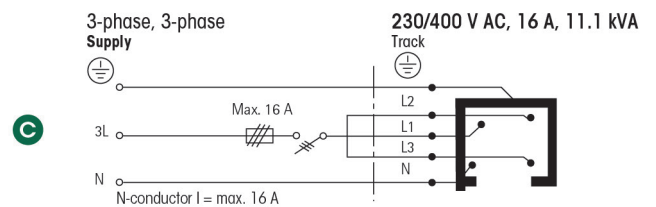
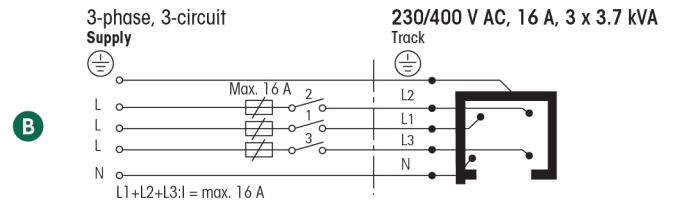
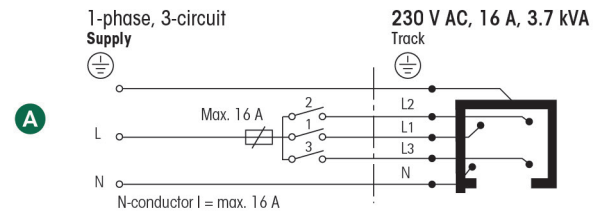

Calha eletrificada de superfície

<b>BL</b> 1m. <b>ACR1BLV2</b>	<b>BL</b> 2m. <b>ACRBLV2</b>	<b>BL</b> 3m. <b>ACR3BLV2</b>
<b>NE</b> 1m. <b>ACR1NEV2</b>	<b>NE</b> 2m. <b>ACRNEV2</b>	<b>NE</b> 3m. <b>ACR3NEV2</b>

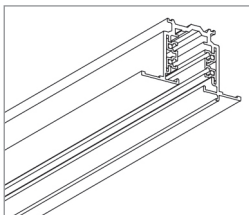

Calha eletrificada de encastrar

<b>BL</b> 1m. <b>ACRE1BLV2</b>	<b>BL</b> 2m. <b>ACREBLV2</b>	<b>BL</b> 3m. <b>ACRE3BLV2</b>
<b>NE</b> 1m. <b>ACRE1NEV2</b>	<b>NE</b> 2m. <b>ACRENEV2</b>	<b>NE</b> 3m. <b>ACRE3NEV2</b>

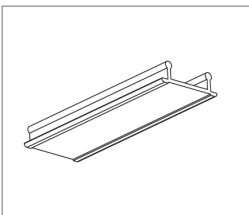

Acessório tampa para cobrir a calha

<b>BL</b> <b>ATCRBLV2</b>
<b>NE</b> <b>ATCRNEV2</b>

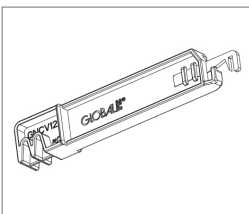

Ferramenta manual para dobrar condutores

**ACRHDCV2**

# ACESSÓRIOS DE UNIÃO E ALIMENTAÇÃO

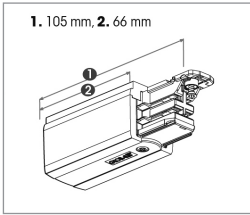

Alimentador eléctrico lateral

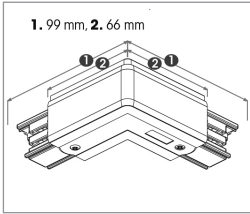
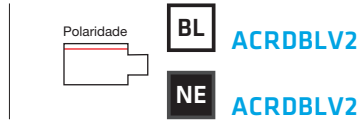

União L

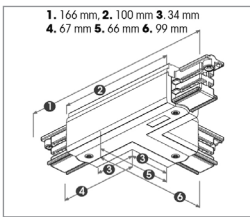
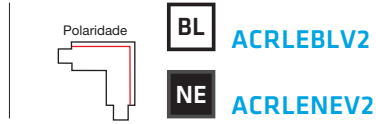

União T

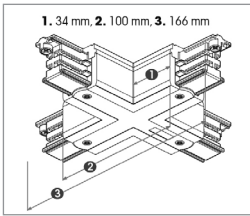
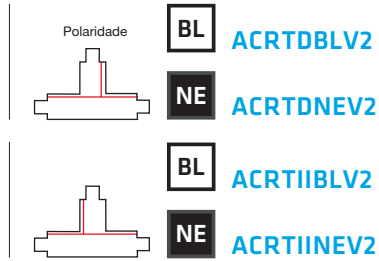
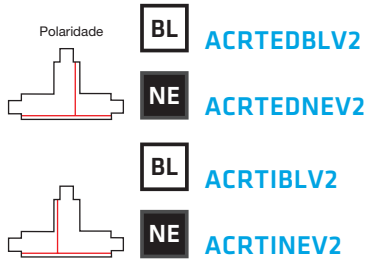

União X

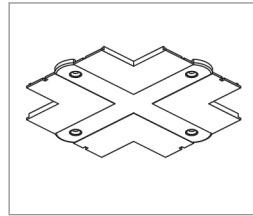
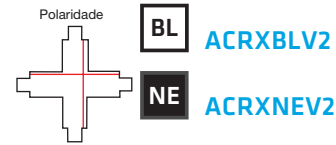

Marco para converter em encastráveis os alimentadores em X

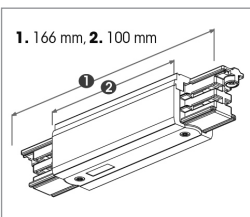

Alimentador eléctrico central

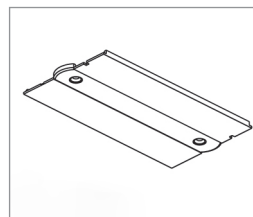

Marco para converter em encastráveis os alimentadores alinhados

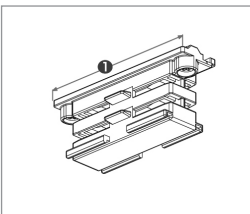

Acessório de união Interior

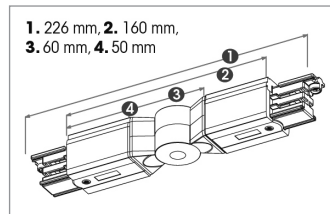

Acessório de união ajustável

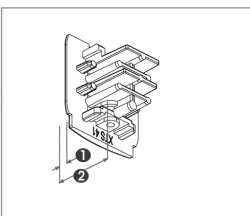

Tampa final

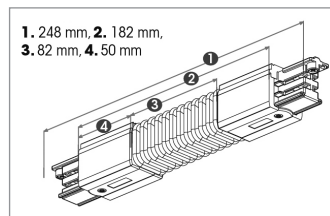

Acessório de união flexível





## ACESSÓRIOS DE SUSPENSÃO

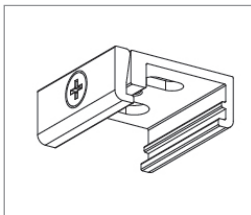

Abraçadeira de superfície

**BL** [AASCRBLV2](#)

**NE** [AASCRNEV2](#)

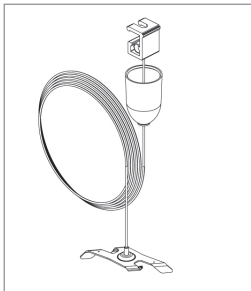

Kit suspensão com clipe

**BL** 1,5m. [ACRS1BLV2](#)

**BL** 3m. [ACRSBLV2](#)

**BL** 5m. [ACRS5BLV2](#)

**NE** 1,5m. [ACRS1NEV2](#)

**NE** 3m. [ACRSNEV2](#)

**NE** 5m. [ACRS5NEV2](#)

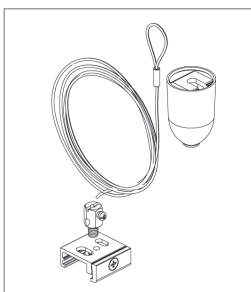

Kit suspensão com abraçadeira

**BL** 1,5m. [ACRSA1BLV2](#)

**BL** 3m. [ACRSA3BLV2](#)

**BL** 5m. [ACRSA5BLV2](#)

**NE** 1,5m. [ACRSA1NEV2](#)

**NE** 3m. [ACRSA3NEV2](#)

**NE** 5m. [ACRSA5NEV2](#)

## ACESSÓRIOS MULTIFUNÇÕES

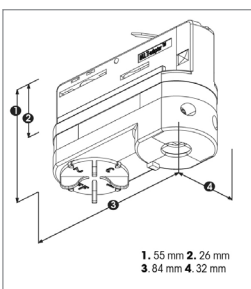

Adaptador Multi circuitos 10A  
ligação com parafuso

**BL** [AMC10BLV2](#)

**NE** [AMC10NEV2](#)

1. 55 mm 2. 26 mm  
3. 64 mm 4. 32 mm

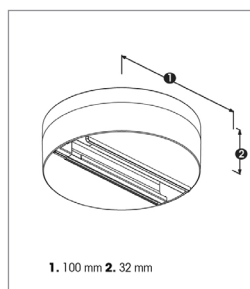

Acessórios de superfície

**BL** [AST110BLV2](#)

**NE** [AST110NEV2](#)

1. 100 mm 2. 32 mm

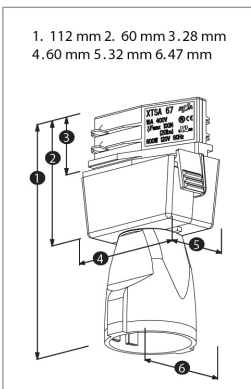

Adaptador Schuko 16A

**BL** [ASCHU16BLV2](#)

**NE** [ASCHU16NEV2](#)

1. 112 mm 2. 60 mm 3. 28 mm  
4. 60 mm 5. 32 mm 6. 47 mm

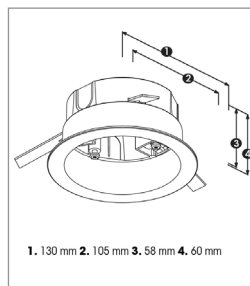

caixa encastrável para  
acessórios de superfície

**BL** [AET105BLV2](#)

**NE** [AET105NEV2](#)

1. 130 mm 2. 105 mm 3. 58 mm 4. 60 mm









THREELINE 

