



Especial
TRACKLIGHT

APOLO

El tracklight de formato compacto.

Con una reproducción cromática muy alta, CRI>90, logrando así una visualización real sin distorsionar el color.

Elige el modelo que más se adapte a tus necesidades:

- 3 Formatos: tracklight, empotrar y superficie.
- 3 Potencias: 9W, 18W y 30W.
- 5 Lentes: 15°, 23°, 38°, 45° y 60°.
- 3 Temperaturas de color: 4000K, 3000K y 2700K.
- 2 Acabados: blanco y negro.

También se ofrece la posibilidad de elegir el aro interno de la luminaria en color dorado.

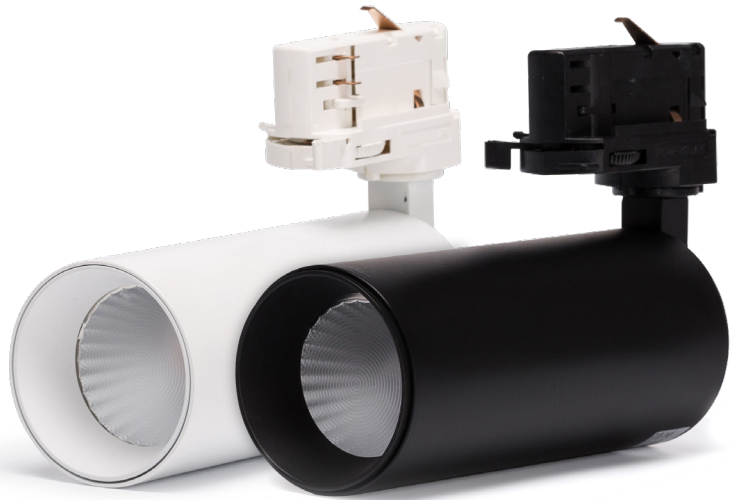

• Características

• Opc. de Reg.

• Ángulos

Posibilidad de aro dorado



Y como **NOVEDAD** podrás elegir la luminaria APOLO para lámparas GU10. Disponible a partir de 09/24. Lámpara no incluida.



CR Carril
 POL2.GU10
 B

EM Empotrar
 N

SP Superficie
 D

*Genera tu referencia

Formato	W	CRI	CCT	Ángulo	ARO	OPCIONAL									
CR Carril	POL2. (Apolo)	09	9 W	9	>90	4	● 4000K	15	15°	B	<input type="checkbox"/>	B	<input type="checkbox"/>		D
EM Empotrar	18	18 W	3	● 3000K	23	23°	N	<input checked="" type="checkbox"/>	N	<input checked="" type="checkbox"/>					
SP Superficie	30	30 W	2	● 2700K	38	38°				D	<input checked="" type="checkbox"/>				
					45	45°									
					60	60°									

W	CCT	N	Ángulo
● 4000K	1080 lm	909 lm	
● 3000K	1071 lm	873 lm	
● 2700K	1062 lm	855 lm	

W	CCT	N	Ángulo
● 4000K	2160 lm	1818 lm	
● 3000K	2142 lm	1746 lm	
● 2700K	2124 lm	1710 lm	

W	CCT	N	Ángulo
● 4000K	3600 lm	3030 lm	
● 3000K	3570 lm	2910 lm	
● 2700K	3540 lm	2850 lm	

HERMES

El tracklight más completo del mercado en una única luminaria con cuerpo de aluminio.

Incorpora en el mismo producto las tres temperaturas de color y tres potencias diferentes, 30W, 35W y 40W, que mediante el selector manual podrás elegir.

Además, dispone de zoom para variar el ángulo y ajustarlo entre 24° y 60°. Y con CRI>90. Solo tendrás que elegir entre acabado blanco o negro.

¡Un mismo producto, diferentes posibilidades!

Características

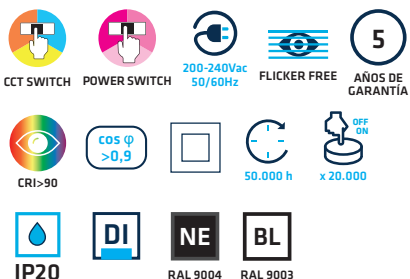

24°~60° **Ángulo ajustable 24°~60°**

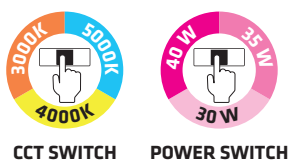

	W	CCT	Beam Angle	Light Output
CRH3040C9CCT	30 W	5000K	0°~90°	3600 lm
		4000K	0°~90°	3600 lm
		3000K	0°~90°	3450 lm
		5000K	24°~60°	4200 lm
		4000K	24°~60°	4200 lm
		3000K	24°~60°	4025 lm
	40 W	5000K	0°~90°	4800 lm
		4000K	0°~90°	4800 lm
		3000K	0°~90°	4600 lm
		5000K	24°~60°	4800 lm
		4000K	24°~60°	4800 lm
		3000K	24°~60°	4600 lm

Añadir detrás de la referencia un 0 para acabado blanco ó un 2 para acabado negro.

ARES

El modelo de tracklight más competitivo.

Disponible en blanco o negro y con selector manual de temperatura de color (CCT SWITCH) y selector manual de potencia.

Solo tendrás que elegir entre acabado blanco o acabado negro y el ángulo que necesites 45° o 60°. Las potencias y temperaturas de color se seleccionan directamente sobre el producto.



• Características

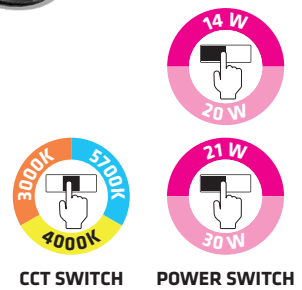
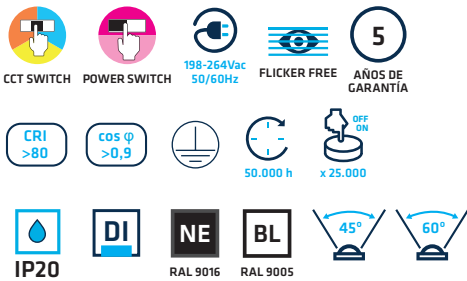

	□	■	W	CCT	lm	lm	
CRA1420CCT45	0	2	45°	14 W	5700K	1580	1300
					4000K	1580	1300
	2	45°	20 W	3000K	1455	1180	
				5700K	2170	1770	
				4000K	2170	1770	
				3000K	1960	1560	
CRA1420CCT60	0	2	60°	14 W	5700K	1580	1300
					4000K	1580	1300
	2	60°	20 W	3000K	1455	1180	
				5700K	2170	1770	
				4000K	2170	1770	
				3000K	1960	1560	
CRA2130CCT45	0	2	45°	21 W	5700K	2350	1950
					4000K	2350	1950
	2	45°	30 W	3000K	2190	1770	
				5700K	3180	2570	
				4000K	3180	2570	
				3000K	2940	2350	
CRA2130CCT60	0	2	60°	21 W	5700K	2350	1950
					4000K	2350	1950
	2	60°	30 W	3000K	2190	1770	
				5700K	3180	2570	
				4000K	3180	2570	
				3000K	2940	2350	

METIS

El tracklight para lámparas GU10.

La facilidad de instalación y su diseño minimalista son sus principales características.

Gracias a su ventosa de soporte, podrás instalar la lámpara LED GU10 sin ningún esfuerzo.

Disponible en tracklight o aplique en superficie para 1, 2, 3 o 4 unidades por luminaria, orientando cada uno de los puntos de luz de forma independiente.



VENTOSA INCLUIDA*

*Necesaria para la colocación y el cambio de la lámpara.



METIS TRACKLIGHT



METIS SUPERFICIE 1 UD.



METIS SUPERFICIE 3 UDS.



METIS SUPERFICIE 2 UDS.



METIS SUPERFICIE 4 UDS.

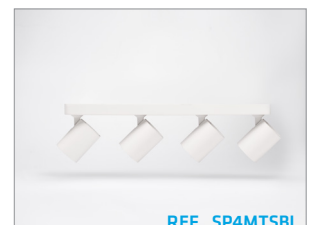

ACCESORIOS PARA CARRIL DE TRES FASES

Accesorios para conseguir todo tipo de instalación.

¿Buscas la solución perfecta para iluminar tus espacios comerciales, públicos o de oficina? ¡No busques más! THREELINE te ofrece, la elección indiscutible de los profesionales y fabricantes de iluminación.

Calidad Inigualable:

Con una garantía del 100% de calidad. Confía en nuestra larga experiencia y disfruta de la iluminación más fiable del mercado.

Versatilidad en Espacios:

Desde tiendas y grandes almacenes hasta restaurantes, aeropuertos y edificios públicos, nos adaptamos a cualquier entorno.

Fácil Ampliación:

¿Necesitas más luz? No hay problema. La estructura modular facilita la expansión según tus necesidades. Los diseñadores pueden ajustar el sistema al espacio adecuado, y los conectores fiables permiten un montaje rápido y sencillo, ¡ahorrando costes en el proceso!

No pierdas la oportunidad de transformar tus espacios con nuestros accesorios de tracklight. ¡Ilumina con inteligencia y estilo!

Mira este ejemplo que te proponemos y verás que ninguna instalación se te resiste.

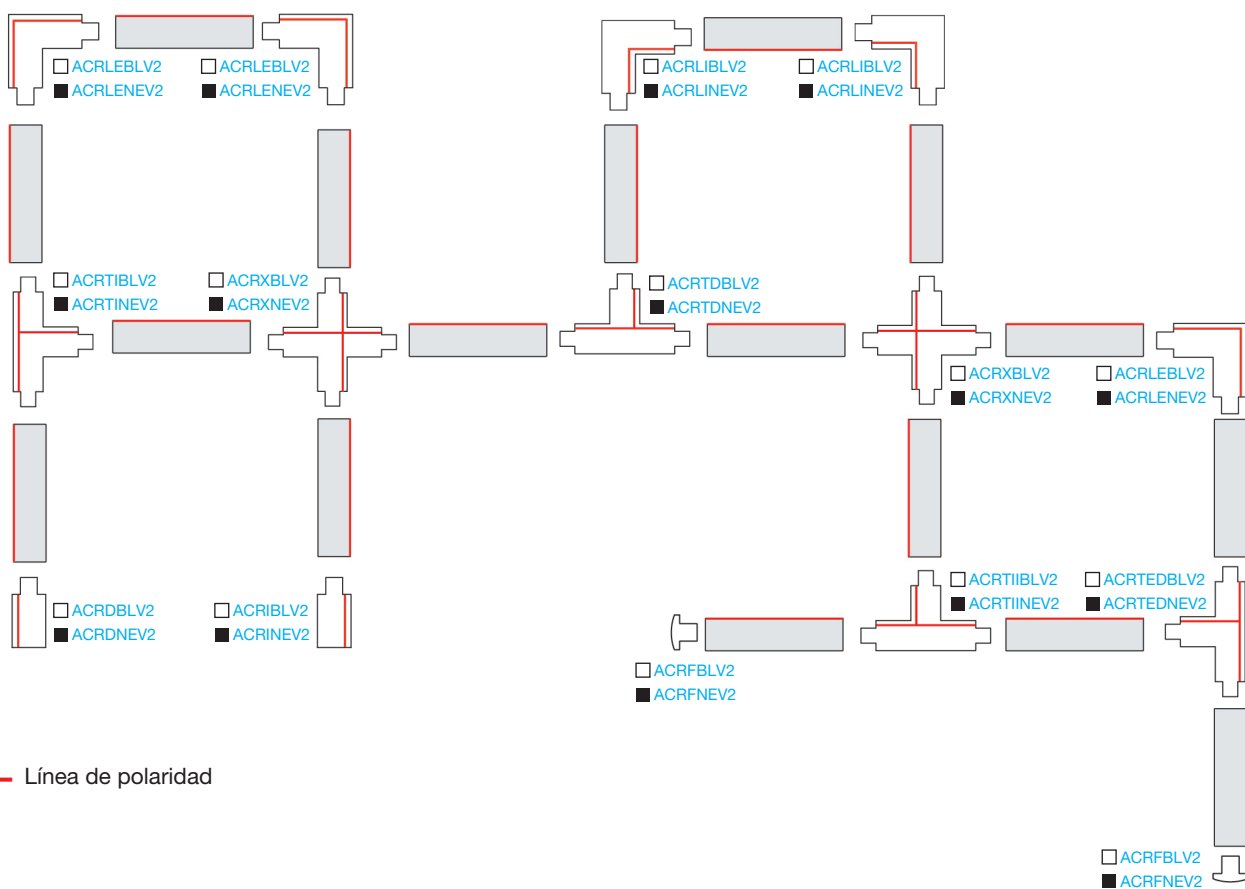
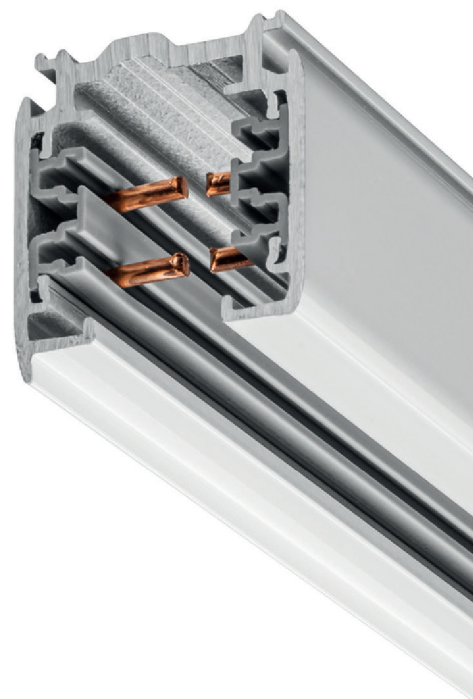

Carril de SUPERFICIE

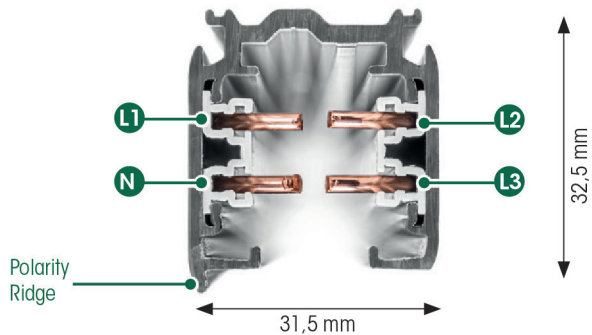

Carril de EMPOTRAR

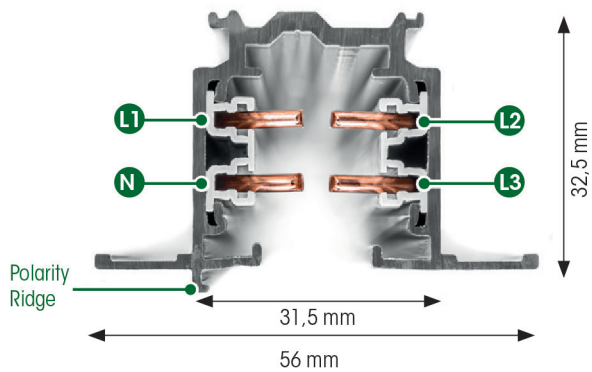

Sección transversal del conductor de potencia

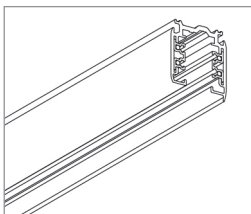
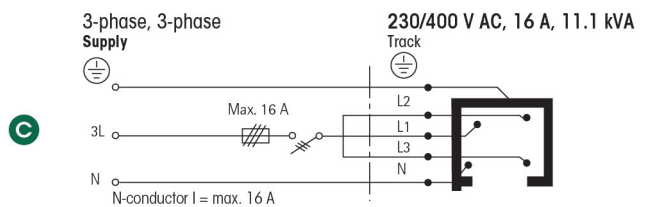
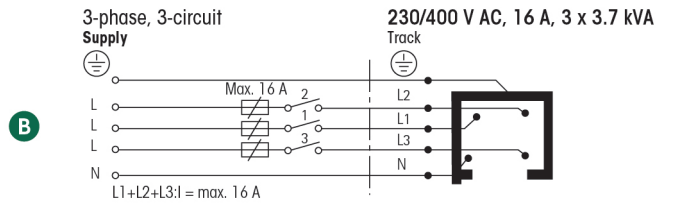
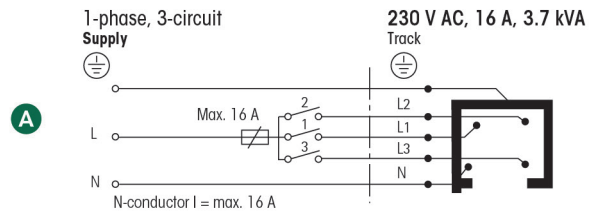

Carril Electrificado de Superficie

BL 1m. ACR1BLV2	BL 2m. ACRBLV2	BL 3m. ACR3BLV2
NE 1m. ACR1NEV2	NE 2m. ACRNEV2	NE 3m. ACR3NEV2

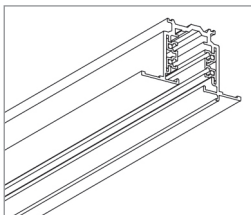

Carril Electrificado para Empotrar

BL 1m. ACRE1BLV2	BL 2m. ACREBLV2	BL 3m. ACRE3BLV2
NE 1m. ACRE1NEV2	NE 2m. ACRENEV2	NE 3m. ACRE3NEV2

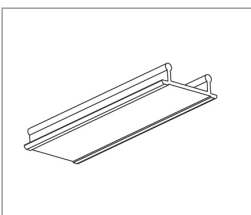

Accesorio tapa cubre carril

BL ATCRBLV2
NE ATCRNEV2

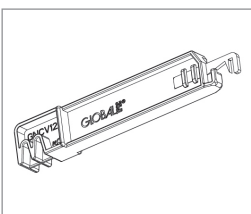

Herramienta manual dobla conductores

ACRHDCV2

ACCESORIOS DE UNIÓN Y ALIMENTACIÓN

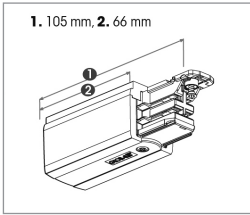

Alimentador eléctrico lateral

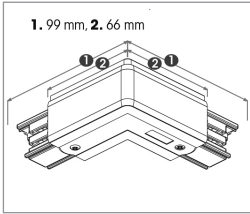
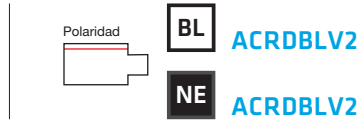

Junta en L

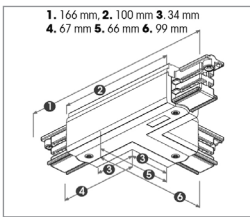
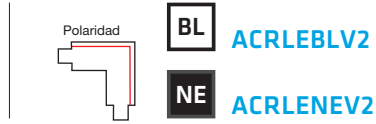

Junta en T

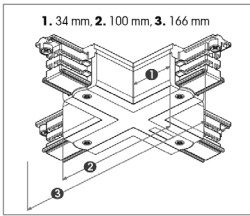
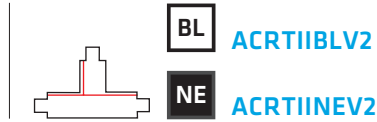
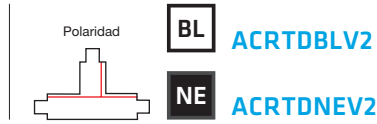

Junta en X

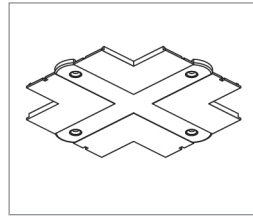
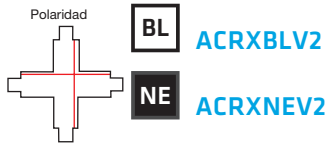

Marco para convertir en empotrable las alimentaciones en X

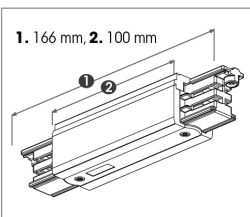

Alimentador eléctrico central

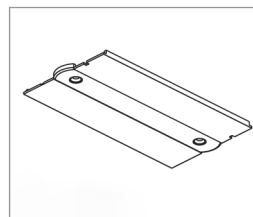

Marco para convertir en empotrable las alimentaciones recto

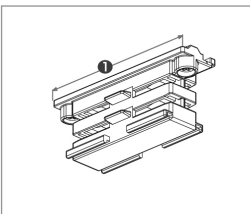

Junta de unión Interior

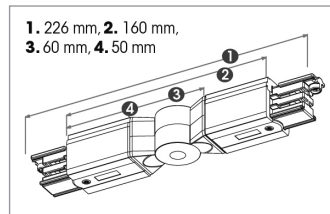

Junta de unión Ajustable

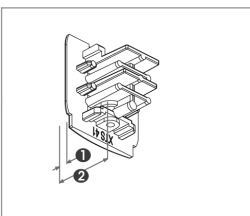

Tapa final

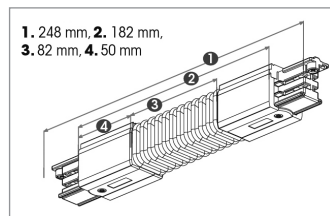

Junta de unión Flexible



ACCESORIOS DE SUSPENSIÓN

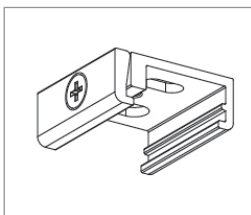

Abrazadera de Superficie

BL [AASCRBLV2](#)

NE [AASCRNEV2](#)

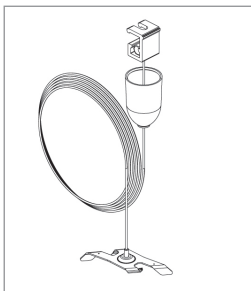

Kit Suspensión con clip

BL 1,5m. [ACRS1BLV2](#)

BL 3m. [ACRSBLV2](#)

BL 5m. [ACRS5BLV2](#)

NE 1,5m. [ACRS1NEV2](#)

NE 3m. [ACRSNEV2](#)

NE 5m. [ACRS5NEV2](#)

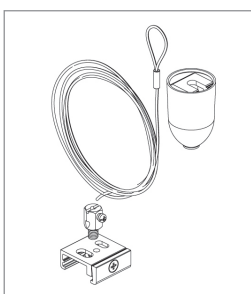

Kit Suspensión con abrazadera

BL 1,5m. [ACRSA1BLV2](#)

BL 3m. [ACRSA3BLV2](#)

BL 5m. [ACRSA5BLV2](#)

NE 1,5m. [ACRSA1NEV2](#)

NE 3m. [ACRSA3NEV2](#)

NE 5m. [ACRSA5NEV2](#)

ACCESORIOS MULTIADAPTADORES

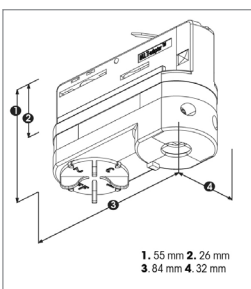

Adaptador Multi circuitos 10A
conexión con tornillo

BL [AMC10BLV2](#)

NE [AMC10NEV2](#)

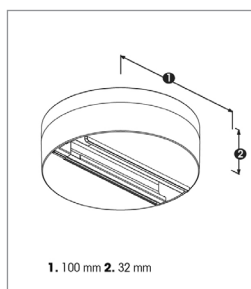

Accesorio de Superficie

BL [AST110BLV2](#)

NE [AST110NEV2](#)

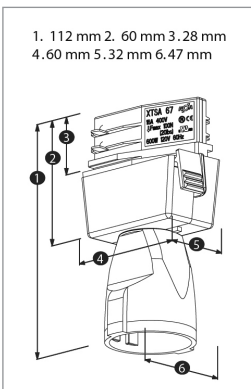

Adaptador Schuko 16A

BL [ASCHU16BLV2](#)

NE [ASCHU16NEV2](#)

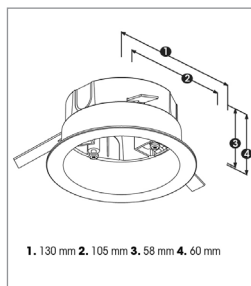

Caja Empotrable para
Accesorios de superficie

BL [AET105BLV2](#)

NE [AET105NEV2](#)





THREELINE 

